

JANUARY 2022

RISK CONTROL PRACTICE: OCCUPANCY

Aluminium Handbook

Didier L. SCHÜTZ

Risk Control Practice Leader,
SCOR Global P&C

SCOR
The Art & Science of Risk



As a founding signatory of the United Nations Environment Programme's Principles for Sustainable Insurance, and a member of industry Net-Zero Alliances, SCOR is committed to engaging with policymakers and other stakeholders to identify and implement the required measures to tackle climate change. Through the review of our underwriting and investment policies and guidelines and future targets and commitments under the Net Zero frameworks, we seek to enable and indeed accelerate society's shift to a net-zero carbon economy by 2050.

Our conviction is that we have an important role to play in insuring the transition and will actively support our clients in their own commitments to follow credible transition pathways as they transform their business model toward net zero.



Disclaimer:

SCOR accepts no responsibility or liability for any use of this handbook by any party to underwrite any particular risk or to determine an MPL or final loss amount. It is the responsibility of the relevant underwriter and (re)insurer to independently determine whether to accept, or not, any particular risk and the contract terms and prices required.

Copyright:

© Copyright SCOR Global P&C SE. All rights reserved. Permission granted to reproduce for personal and educational use only.

© Shutterstock: Image(s) used under license from Shutterstock.com

© Google image(s) labeled for reuse

© Didier Schütz - DLS



CONTENT

SCOPE	8
ACKNOWLEDGMENTS	8
I - ALUMINUM INDUSTRY OVERVIEW	9
1. ALUMINUM PRODUCTS.....	9
2. ALUMINUM PRODUCTION SEGMENTS	10
3. PRIMARY ALUMINUM PRODUCTION OVERVIEW.....	10
3.1. Bauxite Mining	11
3.2. Alumina Production.....	11
3.3. Aluminum Production.....	12
3.4. Cast House.....	13
3.5. Developing Technologies.....	14
3.6. Sustainability Risk Management (SRM).....	15
4. ALUMINUM DOWNSTREAM	16
5. RECYCLING.....	17
II -SUPPLY CHAIN	18
1. WORKFLOW	18
2. INTERDEPENDENCIES, BI, CBI (CTE), SI.....	19
3. LOSS ESTIMATE CONSIDERATIONS	24
4. SCOR LOSS ESTIMATES.....	25
4.1. Maximum Possible Loss (MPL).....	25
4.2. Normal Loss Expectancy (NLE)	25
4.3. Loss Estimates used for the current document	25
5. MITIGATING MEASURES – CP, BCP/M.....	26
5.1. Terminology & Definition	26
5.2. Reliability Issues	27
5.3. When to consider a CP, BCP/M.....	27
III - BAUXITE MINE FOCUS	29
1. PROCESS.....	29
2. SPECIAL HAZARDS & RISK CONTROL.....	29
2.1. Mines	29
2.2. Drilling and Blasting	32
2.3. Waste Handling	32
2.4. Bauxite Ore Handling.....	32
2.5. Mobile Mining Equipment and Related Facilities	36
2.6. Utilities	38
2.7. Control System	40



3.	CONTINGENCY / BUSINESS CONTINUITY / RECOVERY PLAN	40
4.	LOSS ESTIMATES	41
IV -	ALUMINA REFINERY FOCUS	42
1.	PROCESS	42
2.	SPECIAL HAZARDS & RISK CONTROL	44
2.1.	Bauxite Ore Handling	44
2.2.	Slurry Preparation	45
2.3.	Bauxite Ore Processing (from “red side” to “white side”)	45
2.4.	Alumina Storage & Handling	48
2.5.	Utilities	48
2.6.	Control Systems	49
2.7.	Spare Parts Warehouse	49
2.8.	Tailing	50
3.	CONTINGENCY / BUSINESS CONTINUITY / RECOVERY PLAN	52
4.	LOSS HISTORY	53
4.1.	High Pressure Rupture of the Digester	53
4.2.	Flood events impacting tailing	54
5.	LOSS ESTIMATES	54
V -	ALUMINUM SMELTER FOCUS	56
1.	PROCESS	56
2.	SPECIAL HAZARDS & RISK CONTROL	59
2.1.	Carbon Plant	59
2.2.	Reduction Plant	64
2.3.	Cast House	70
2.4.	Utilities	72
2.5.	Control System	77
2.6.	Spare Parts Warehouse	77
3.	CONTINGENCY / BUSINESS CONTINUITY / RECOVERY PLAN	78
4.	LOSS HISTORY	90
4.1.	Power outage due to loss of single feeder	90
4.2.	Power outage due to ice storm impacting national grid	90
4.3.	Fire in paste plant	90
4.4.	Power blackout due to human error & in-built safety	90
4.5.	Power Outage due to setup of feeder circuit breakers	91
4.6.	Multiple pot failure	92
4.7.	Fire Event at Power Substation	92
4.8.	Pot Leakage damaging the busbar resulting in power loss	93
4.9.	Bus bar failure resulting in power loss	93



5.	LOSS EXPERIENCE ANALYSIS.....	94
5.1.	Smelter loss origins.....	94
5.2.	Electrical interruption observed in SCOR’s Claims History.....	94
5.3.	Major Pot Freeze Comparison	95
5.4.	Reinstatement Period	98
5.5.	Pot life reduction after relining.....	98
5.6.	Additional Costs.....	99
6.	LOSS ESTIMATES.....	100
VI -	ALUMINUM ROLLING MILL FOCUS	108
1.	PROCESS.....	108
2.	SPECIAL HAZARDS & RISK CONTROL.....	114
2.1.	Construction.....	114
2.2.	Fire Hazards	114
2.3.	Hydraulic Fluids	118
2.4.	Rolling Fluids	118
2.5.	Fume Exhaust.....	119
2.6.	Combustible Dust Hazard	120
2.7.	Mill Equipment	122
2.8.	Utilities	124
2.9.	Control System	126
2.10.	Spare Parts Warehouse	126
2.11.	Contingency / Business Continuity / Recovery Plan.....	127
3.	LOSS HISTORY	128
4.	LOSS ESTIMATES.....	128
VII -	RECYCLING FOCUS.....	130
1.	PROCESS.....	130
2.	SPECIAL HAZARDS & RISK CONTROL.....	131
2.1.	Construction.....	131
2.2.	Conveyor	131
2.3.	Remelt Furnace & De-lackering Kiln	132
2.4.	Hydraulic & Lubricating groups	132
2.5.	Utilities	132
2.6.	Control System	133
2.7.	Spare Parts Warehouse.....	134
3.	CONTINGENCY / BUSINESS CONTINUITY / RECOVERY PLAN.....	134
4.	LOSS ESTIMATES.....	135
VIII -	CALCINATION PLANT FOCUS	136
1.	PROCESS.....	136



2.	SPECIAL HAZARDS & RISK CONTROL.....	138
2.1.	Green Coke Storage & Handling.....	138
2.2.	Rotary Kiln / Afterburner.....	139
2.3.	Utilities	139
2.4.	Control System.....	140
2.5.	Spare Parts Warehouse.....	140
3.	CONTINGENCY / BUSINESS CONTINUITY / RECOVERY PLAN.....	140
4.	LOSS ESTIMATES.....	141
IX -	IMPORT / EXPORT FACILITIES FOCUS.....	142
1.	PROCESS.....	142
2.	SPECIAL HAZARDS & RISK CONTROL.....	144
2.1.	Ship Loader / Unloader.....	144
2.2.	Storage Facilities.....	145
2.3.	Rubber Belt Conveyor.....	146
2.4.	Utilities	146
2.5.	Control System.....	147
3.	CONTINGENCY / BUSINESS CONTINUITY / RECOVERY PLAN.....	147
4.	LOSS ESTIMATES.....	148
X -	UTILITIES (POWER / WATER) FOCUS.....	149
1.	PROCESS.....	149
2.	SPECIAL HAZARDS & RISK CONTROL.....	149
2.1.	Captive Power Plant.....	149
2.2.	Transmission & Distribution (T&D).....	152
2.3.	Power Distribution System (PDS).....	153
2.4.	Desalination Plant.....	154
2.5.	Fume Treatment.....	155
2.6.	Control System.....	155
2.7.	Spare Parts Warehouse.....	155
3.	CONTINGENCY / BUSINESS CONTINUITY / RECOVERY PLAN.....	155
4.	LOSS HISTORY.....	156
4.1.	Loss at Smelter due to Service Interruption.....	156
4.2.	Cooling Tower Fire.....	157
5.	LOSS ESTIMATES.....	157
XI -	SUPPORT FOR LOSS PREVENTION RECOMMENDATIONS.....	158
1.	CAPTIVE POWER PLANT – GAS TURBINE.....	158
2.	CAPTIVE POWER PLANT - STEAM TURBINE.....	158
2.1.	Turbine generator operating floor.....	158
2.2.	The lubrication group.....	161



2.3. Exciter	163
2.4. Hydrogen seal oil	163
2.5. Feed water pumps	163
2.6. Oil storage areas / Discharge tank area	164
2.7. Cable concentrations in the Turbine Hall	164
2.8. Hydrogen	164
2.9. Emergency hydrogen drainage valve	164
2.10. Combustible roof for Turbine Hall building	164
2.11. Additional specifications	164
2.12. Sketch of an automatic protection location overview in a Turbine Hall	165
3. STATIONARY COMBUSTION ENGINE AND GAS TURBINE	166
4. TRANSFORMER	167
5. ELECTRO-STATIC PRECIPITATOR (ESP)	176
6. SUBSTATION / MCC ROOM / SERVER ROOM / ELECTRIC ROOMS	177
7. CABLE OPENINGS / CABLE TRAYS & RUN / CABLE VAULTS / CABLE TUNNELS	179
8. BATTERY ROOM (ESS)	180
9. RUBBER BELT CONVEYOR	181
10. COOLING TOWER	186
11. HYDRAULIC / LUBRICATING GROUPS	190
12. HEAT TRANSFER FLUID / MEDIA (HTF/HTM)	192
13. PASTE PLANT FIXED FIRE PROTECTION	193
14. AIR COMPRESSOR	194
15. FUEL LINE SAFETY COMBUSTION CONTROL	195
16. HAZMAT & AEROSOLS & COMPRESSED GAS CYLINDERS	197
17. OVERHEAD CRANES	198
18. CONTROL ROOM	199
19. WAREHOUSE	200
20. DUCT SPRINKLER PROTECTION	201
21. IGNITABLE LIQUID STORAGE TANK	203
XII - ANNEX	204
1. ANNEX A: TECHNICAL REFERENCES	204
2. ANNEX B: EXPLANATORY MATERIAL	205
2.1. Alumina Raw Material - Nepheline	205
2.2. Alumina Refining – Products	205
2.3. Alumina Refining – Use of Red Mud	206



SCOPE

The purpose of this Handbook / Guidance Note is to provide comprehensive technical support to Underwriters and Risk Control Engineers.

Although this Handbook / Guidance Note is detailed and deals with a number of perils and potential scenarios, it is not intended to be a comprehensive analysis of every peril and potential scenario an underwriter may be requested to provide cover for. Any estimation or projection of an MPL and final loss amount must be based on reliable, accurate and current values, applicable scenarios and consideration of the relevant perils.

The main processes of the aluminum industry and related special hazards are described.

This guide is mostly focused on fire explosion hazards and natural perils. Boiler & machinery hazards are not covered in detail in this document. Examples of losses are also given when relevant.

Standard recommendations based on recognized international standards and good practices are proposed. Moreover, very good NFPA (National Fire Protection Association) and FM Global Property Loss Prevention Data Sheets on these subjects exist. Since there is no need to reinvent the wheel, readers are referred to those references when relevant.

- NFPA free viewing at <http://www.nfpa.org/>
- FM Global Data Sheets free viewing and download available when registered at <http://www.fmglobal.com/>

Note that these materials are periodically revised and updated. Please monitor the above websites for updates and/or revisions.

ACKNOWLEDGMENTS

Many thanks to the following people and organizations for their invaluable and extensive contributions:

- Aluminium Bahrain B.S.C. (Alba)
- SOHAR Aluminium LLC - Oman
- Virtual i Technologies Ltd, Risk Engineering Service Provider for Aon in the Middle East.
- GARMCO - Gulf Aluminium Rolling Mill Co (Bahrain)
- FM Global. - Factory Mutual Insurance Company
- Nicole Jamieson, Conference Interpreter (AIIC)
- Franck Orset (FPO), Loss Prevention Engineer – drawings and more

This occupancy guide was finally discussed and reviewed by Risk Control Engineers and Claims Managers working for insurance / reinsurance and qualified consultant companies or working as freelance consultants. Many thanks to them. Their names are given in this document with their permission.



I - ALUMINUM INDUSTRY OVERVIEW

Aluminum vs Aluminium: Aluminum was the original spelling of the element. American readers are used to aluminum. Aluminium is the British English word for the same metal.

1. ALUMINUM PRODUCTS

Aluminum metal is used for a wide range of products including, but not limited to:



Transportation (automotive, aircraft, marine) & Defense



Space

Construction

Electrical & Electronics



Packaging, Pharmaceuticals

Consumer goods

Sports

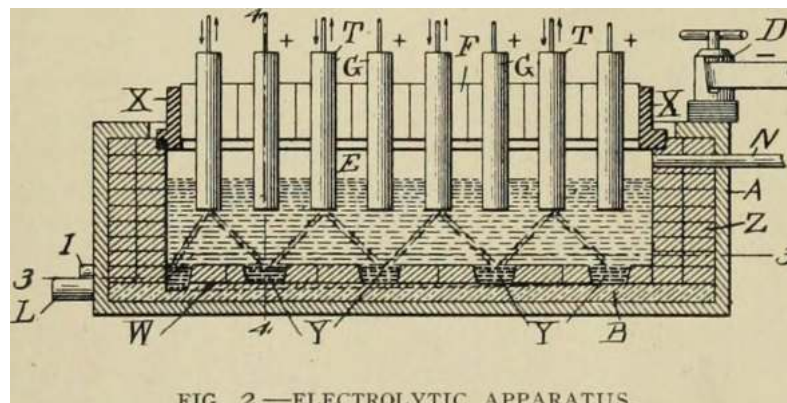

Diagram: Chemical Engineering 1902



2. ALUMINUM PRODUCTION SEGMENTS

There are basically 3 segments as follows:

- Upstream segment: primary aluminum and its alloys
- Downstream segment: the producers of aluminum products
- Recycling: the producers of aluminum out of processed raw material

These 3 segments are summarized in the following sections.

3. PRIMARY ALUMINUM PRODUCTION OVERVIEW

The aluminum production process can be broken down into three stages. First, bauxite, which contains aluminum, is extracted from the ground. Second, bauxite is processed into alumina or aluminum oxide, and finally in stage three, pure aluminum is produced using electrolytic reduction, a process in which aluminum oxide is broken down into its components using an electric current.

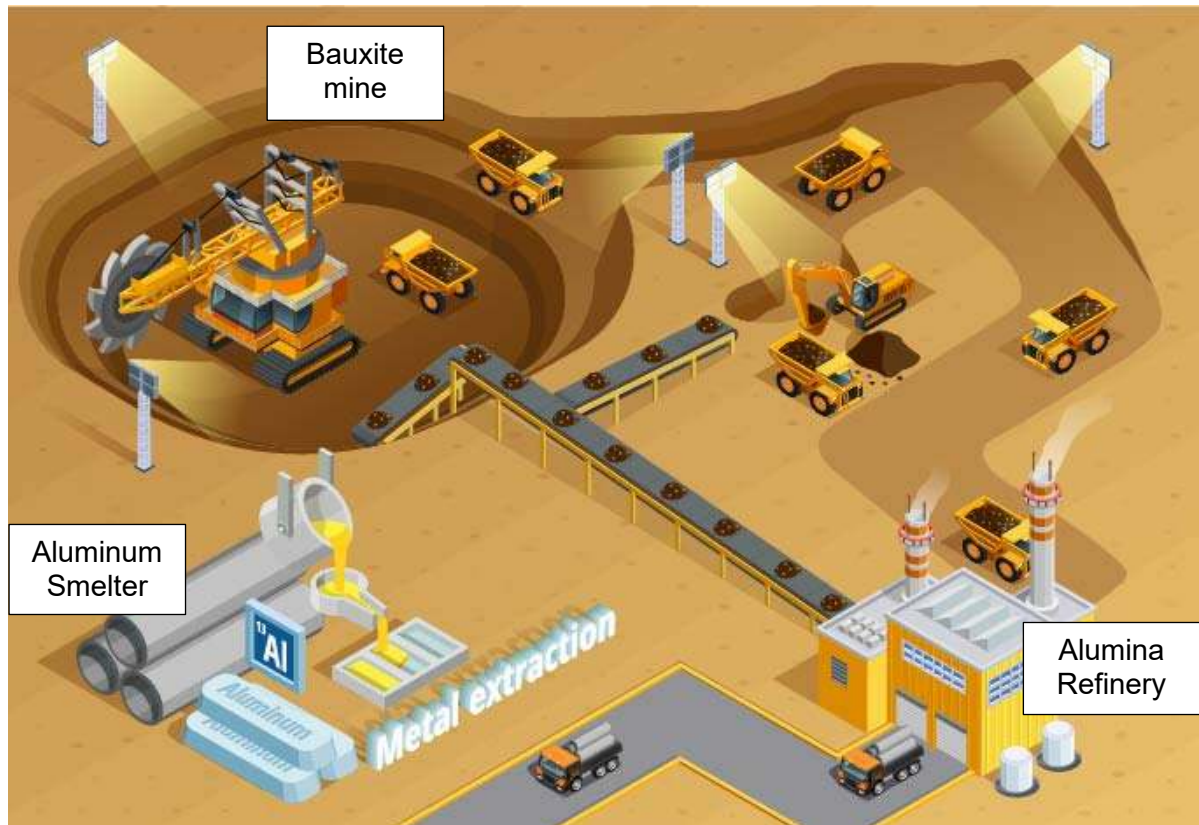

About 4-5 tons of bauxite



is processed into 2 tons of alumina



from which about 1 ton of aluminum can be made



3.1. Bauxite Mining

Bauxite is the ore used in the production of alumina, which in turn is the basic raw material in the aluminum manufacturing process. As the foremost step of the aluminum value chain, bauxite is a competitive determinant in the aluminum business.

Bauxite is a mineral made up primarily of aluminum oxide mixed with some other minerals. Bauxite is regarded as high-quality if it contains more than 50% of aluminum oxide.



The most common way to mine for bauxite is by using open pit mines. Special equipment is used to cut one layer after another off the surface, with the rock then being transported elsewhere for further processing.

However, there are places where aluminum ore has to be mined from deep underground (e.g. Chermkhovskaya-Deep mine in the Urals in Russia, whose shafts run 1,550 m deep)

There is a lot of variation in bauxite.

About 90% of global bauxite supplies are found in tropical and subtropical areas, with 73% found in just five countries: Guinea, Brazil, Jamaica, Australia and India.

3.2. Alumina Production

The next stage in the production chain is the processing of bauxite into alumina, or aluminum oxide - Al_2O_3 , - a white powder. The most common process for making alumina from bauxite is the Bayer process, which was first discovered over 100 years ago but is still widely in use today.

About 90% of alumina refineries in the world use the Bayer process:



The crystallized aluminum hydrate found in bauxite easily dissolves in concentrated caustic soda (NaOH) at high temperatures.



When the temperature is lowered and the concentration of the solution increases again, aluminum hydrate crystallizes.

Other elements contained in the bauxite (so called ballast or red mud) either don't dissolve or recrystallize and settle to the bottom well before aluminum hydrate crystallizes. After aluminum hydrate is dissolved in caustic soda the ballast can easily be isolated and removed.

The Bayer Process is very efficient, but it can only be used on high-quality bauxite with a fairly low content of admixtures, especially silicon.

3.3. Aluminum Production

Aluminum is produced from alumina via the electrolytic reduction process.

Note that some smelters are dedicated to the production of "high purity aluminum for very customized high added value products". Some bauxite containing high content of metal such as gallium and iron may not be suitable for such smelter.

The reduction area is the heart of an aluminum smelter and consists of several rectangular buildings whose length sometimes exceeds 1 km. There are only a handful of people in a typical reduction area as all the key processes are automated. Inside there are hundreds of reduction cells or pots arranged in rows.



In order to create the right environment for electrolysis, another component – cryolite - is necessary. Cryolite is a rare natural fluoride mineral which - due to its scarcity in natural form - has been manufactured artificially. In modern metal production, cryolite is made by mixing hydrofluoric acid with aluminum hydroxide and soda.

The entire cell is filled up with molten cryolite that creates a conductive environment at a temperature of 950°C. The bottom of the cell works as the cathode while the role of the anode is played by special carbon blocks (produced at the carbon plant) that are lowered into the cell.

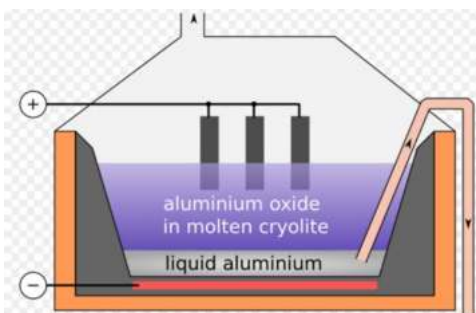

A feeding system dumps a new portion of alumina into the cell several times per day.

The electric current flowing through the cell breaks down the bond between aluminum and oxygen, causing aluminum to settle on the bottom of the cell and form a layer 10-15 cm deep while the oxygen binds with the carbon in the anode blocks to form carbon dioxide.

The constant voltage at the electrodes of each reduction cell varies in the range of between 4 and 6 volts, while the amperage can reach 300-400kA or even more (500-600kA).

The aluminum reduction process requires huge amounts of electric power. The most common energy source is a hydroelectric power plant (e.g. in Russia for 95% of aluminum smelters).



Other places in the world use nuclear power (e.g. France) or gas turbines and combined cycles (e.g. Gulf area). Some places in the world are still dominated by coal-fired generation (e.g. Asia).

Two to four times per day, aluminum gets extracted from the cell by means of special vacuum buckets. A hole is punched in the cryolite crust that forms on the surface of the reduction cell, then a pipe is lowered in through the hole.

Liquid aluminum is sucked through this pipe into the bucket, from which all air has been pumped out in advance.

Once the bucket is full it is taken to the Cast House and/or to the aluminum downstream plants using special Meta Transport & Tilting Vehicles (MTTV).

3.4. Cast House

At this stage the metal still contains a lot of iron, silicon, copper and other elements.

The smallest amounts of admixtures can have a drastic impact on the properties of aluminum.

In the Cast House, not only is aluminum given the required shape but also the required chemical composition as pure aluminum is used far less than aluminum alloys. Some admixtures increase the strength of aluminum, others make it denser, still others change its heat transmission properties, etc. Common alloying elements include boron, iron, silicon, magnesium, manganese, copper, nickel, lead, titanium, chromium, zinc, zirconium, lithium, scandium, silver and others. In addition, aluminum alloys can include dozens of other alloying elements such as strontium, phosphorous and others, so the total number of possible alloys is very impressive.

Today over 100 aluminum alloys are used in industry.



At the Cast House all admixtures are removed by re-melting the aluminum in a special furnace at 800-900°C.

Aluminum alloys are made by mixing aluminum with various other metals (the so-called alloying elements).



The resultant pure aluminum or aluminum alloy is cast into special molds where it is allowed to solidify:



The smallest aluminum ingots, often called pigs, weigh between 6 and 24 kg



Sow ingots can weigh 700 kg and more



The largest ingots are 30-tonne slabs 11.5 m in length



Long aluminum billets are 7 m long

3.5. Developing Technologies

Operating at Higher Amps:

Aluminum producers are constantly refining their production processes to maximize quality while minimizing costs and the environmental footprint. Reduction cells have already been designed that operate at 400 and 500 kA amperage, while older generation reduction cells are being modernized.

Operating at higher amps increases efficiency and quality. However, it also implies more heat produced that needs to be dissipated and the life span of the pot may be reduced.

Inert Anodes (or non-consumable):

When carbon (or consumable) anodes are used, the reaction frees up the oxygen present in the alumina, but it immediately reacts with the carbon from the anode to form CO₂ (Green House Gas – GHG). The process, as such, consumes over 400 kg of carbon anodes per ton of aluminum.

One of the most cutting-edge technologies aluminum producers are working on today is the inert anode (or non-consumable) process. The inert anode can potentially be used ad infinitum. This is currently under development.

Using inert (or non-consumable) anodes avoids the formation of CO₂, so that only pure oxygen is produced as a byproduct. If successfully developed and applied, inert anode technology could have significant energy, cost, productivity and environmental benefits for the aluminum industry worldwide.



An electrolysis cell equipped with inert anodes has potentially several advantages over a carbon anode-equipped cell:

- No need for frequent anode changes
- No need of a carbon plant
- No need of a bath handling facility
- More stable pot operations (the anode change, in fact, is a quite disturbing process for the electrolysis process)
- Possibility of retrofitting an existing cell with inert anodes
- No more production of greenhouse gases (CO₂)

However, inert anode technology also has several disadvantages. The carbon anodes participate in the alumina reduction reaction producing heat directly inside the bath (through the reaction $C + O_2 \rightarrow CO_2$). If an inert anode is used, there is no participation in the chemical reaction and no heat generated in the bath. To keep the same pot thermal balance, the missing heat has to be provided through external voltage.

Composite Anodes:

Considering the difficulties of developing Inert Anodes, most research on anode materials is, therefore, focused on finding and developing the right alloys and/or composite materials that possess low corrosion characteristics (i.e. low consumption rates), so that the anode lifespan is optimized. Examples of anode materials being researched or under development are: ceramic anodes, cermet anodes, metal (alloy) anodes and various coatings. Composite anodes should possess desirable properties such as:

- low solubility in the electrolyte
- high resistance to oxygen produced at the anode
- high electric and negligible ionic conductivity
- low oxygen overvoltage
- resistance to electrolytic decomposition of the oxide material
- adequate mechanical strength
- easy electrical connection
- non-polluting in manufacture, use and disposal,
- acceptable contamination of the aluminum produced
- economically attractive

Use of Wettable Cathodes:

Wettable cathode technology mainly consists of the development of binders, the manufacture of the composites, their application on the cathode surface and their resistance to sodium penetration in the cathode lining.

By creating a cathode surface that is inert and wettable to the molten aluminum pad, which acts as the cathode for the electrolysis reaction, the anode-cathode distance can be reduced by half or more, thereby reducing the voltage drop with substantial energy savings.

The main advantage of aluminum-wettable cathode coatings appears to be for future multi-cell designs and for new electrolysis pot designs rather than for revamping existing Hall-Héroult aluminum electrolysis cells.

3.6. Sustainability Risk Management (SRM)

Sustainability risk management (SRM) is a business strategy that aligns profit goals with a company's environmental and social policies.



Although aluminum is easy to recycle, making primary aluminum requires a lot of energy. With renewable power and modern technology, most of the major players of the aluminum industry are making a lot of effort to produce aluminum in the cleanest way possible.

An aluminum plant that bases its electricity on coal, as is common in several regions of the world, has five times higher CO₂ emissions than one that bases it on electricity from renewable sources.

The core strategy of some major players operating different smelters is to grow their operations in regions of the world where they can use power with zero emissions, such as hydropower, wind power, solar power and more.

Other major players operating single smelters focus their efforts on the efficiency of their power supply using the latest combined cycle technology for instance, introducing renewable energy power sources such as wind power and solar power and optimizing their processing lines. Recycling all type of wastes is also a priority. In some smelters, millions are invested in fume treatment, gas treatment, Spent Pot Lines facility and water recycling facility.

Some customers are sourcing aluminum produced with solar energy. This is the case of some automaker operating downstream aluminum facilities (foundries) sourcing much of their aluminum from smelter producing aluminum using solar energy generated at a solar park.

4. ALUMINUM DOWNSTREAM

The following primary aluminum (pure aluminum) or aluminum alloy solid products from the Cast House may be processed by Aluminum Downstream plants producing rolled products, extrusions, foil and packaging segments:

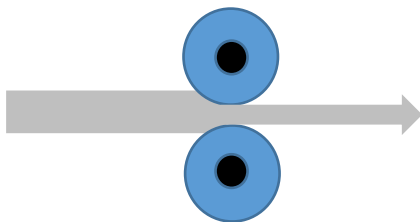

Rolling Mills (hot/cold): slabs are usually rolled into thin sheets that are then used in the manufacture of beverage cans, circles for cooking equipment manufacturers, aluminum foil for packaging product manufacturers, engineering and construction or automobile body panels.

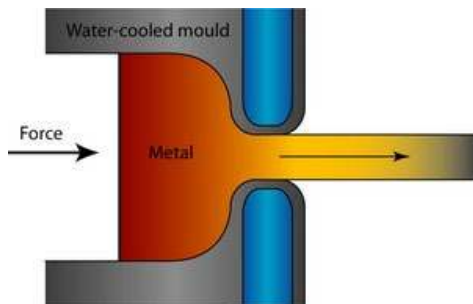

Extrusion: 7m long aluminum billets are pushed through a hole of the required shape. Extrusion is the process used for making the vast majority of aluminum products.



When customers get aluminum delivered to them in pigs / sow, they re-melt them, add whatever components they need and then recast them in the shape needed for their purposes before further processing them into a large number of products for various downstream applications.

Hot liquid can also be received directly from the smelter and wire rods are manufactured in a continuous casting and rolling process:



Electrical conductor (EC) wire rods are used for the production of cables and ACSRs (Aluminum Conductor Steel-Reinforced) and AACs (All Aluminum Conductor).

Alloy wire rods are used to produce AAACs (All Aluminum Alloy Conductor).

5. RECYCLING

One important property of aluminum is that it preserves its properties after processing, which means aluminum products can be recycled into new products.

Aluminum scrap is collected all over the world. Aluminum cans are one of the most recycled products in the world.



A Can Reclamation Unit (CRU) produces reclaimed aluminum from scrap purchased on the market and scrap from the nearest rolling mill which may then, for instance, be re-melt in the Cast House of the Smelter. The unit includes a de-lacquering kiln and a Tilt Rotary Furnace for removing the coating on the cans.

Recycling requires a far less amount of energy than producing primary aluminum does.

Note that such re-melted aluminum is not accepted by Cast Houses producing primary aluminum (pure aluminum). Reclaimed aluminum contains additives that are a contaminant (giving rise to quality issues).



II - SUPPLY CHAIN

1. WORKFLOW

Legend: Interdependencies (Induced BI) And/or CBI / CTE, SI
 BI/CBI exposures (see next pages)

The process flow between the different units involved in the aluminum business can be summarized as follow © Didier Schütz (DLS):

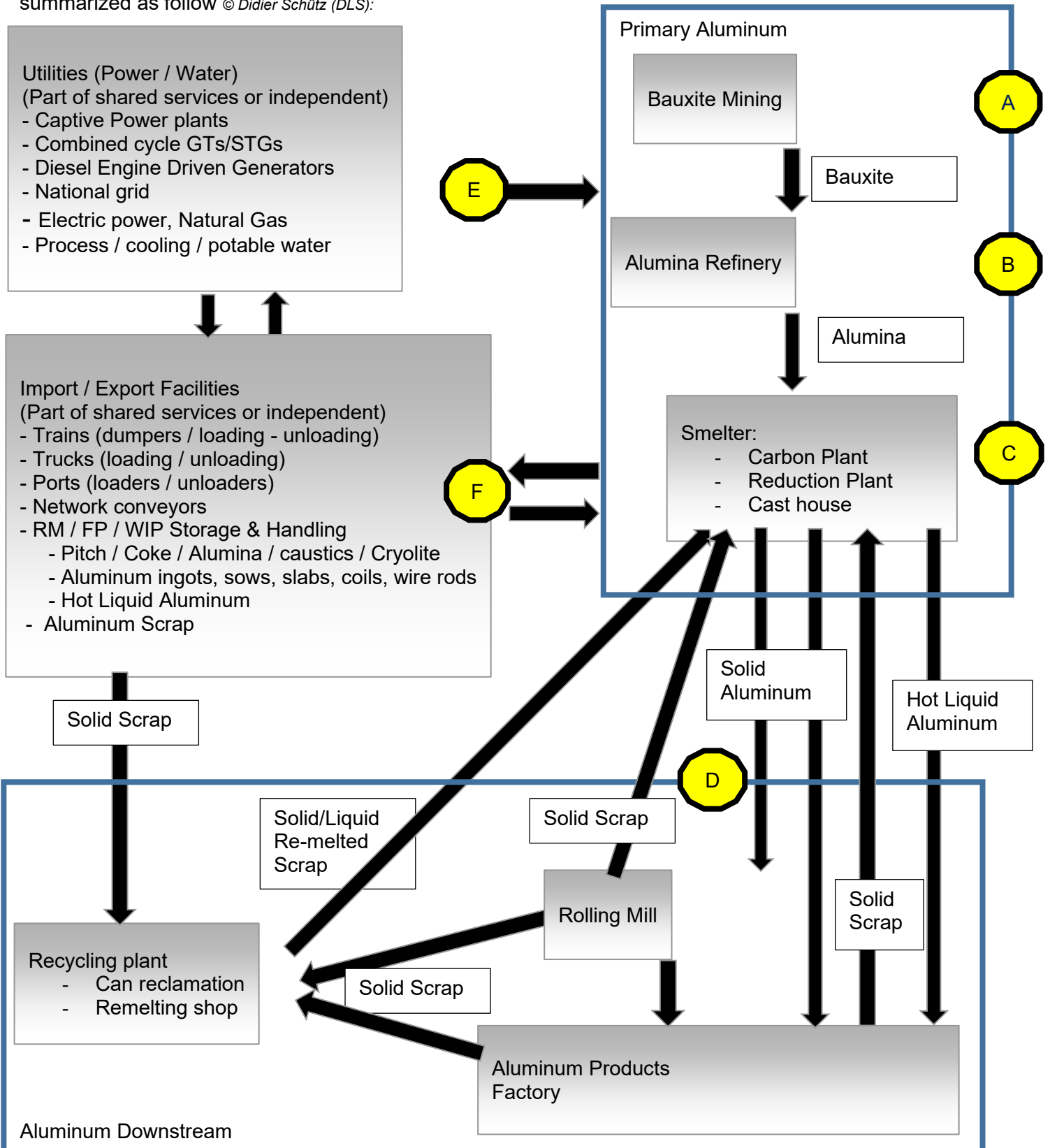



2. INTERDEPENDENCIES, BI, CBI (CTE), SI

Depending on the level of both the vertical and horizontal integration of an organization involved in the Aluminum business, very strong interdependencies may exist e.g. induced BI (sister plants belonging to the same organization) and/or Contingent Business Interruption – CBI / CTE – Contingent Time Element (independent plants) and/or Service Interruption (i.e. services and utilities).

The main potential exposures and mitigation measures are summarized below (this should be carefully investigated for the purpose of calculating loss estimates):

 A	<p>Major loss at the mine resulting in a bauxite supply disruption:</p> <p>A major loss at the mine can disrupt the delivery of bauxite to the refinery, thus resulting in induced BI for the refinery (in case of interdependencies between sister plants of the same group) or Contributing CBI for the refinery (if the mine belongs to a different group).</p> <p>The bauxite ore can also be delivered directly from the mine to the refinery by truck and or train (e.g. the mine and the refinery are sister plants of the same group). Both trains and trucks can be operated by a third party (private or public-owned such as national railways).</p> <p>Note that all Primary Aluminum plants could also be impacted by a bauxite supply disruption such as a smelter not receiving any alumina from the refinery.</p> <p>The smelter could operate partially (with an alternate source of alumina or using buffer storage) or might have to shut down until the alumina supply is restored. In the latest PD and BI, a Controlled Shut Down is required if cells need to be restored (see Aluminum Smelter section for details).</p> <p>Downstream Aluminum could also be impacted i.e. the rolling mill not receiving the required amount of solid aluminum products or other aluminum product factories not receiving the required amount of hot metal from the smelter (as it is only partially operating or shut down entirely).</p> <p>Mitigating measures for the refinery would consist of:</p> <ul style="list-style-type: none">• Diversifying the bauxite ore supply thanks to a contract settled in advance with other mine(s) and securing the contract by having some quantities regularly delivered. Trying to settle an initial contract when the disruption is actually happening would be virtually impossible (especially for bauxite ore).• If the bauxite ore is delivered from the mine to the refinery by truck and/or train, an adequate redundancy (best would be a full redundancy) should be provided (i.e. trucks providing 100% back up for the trains which would still be less expensive. Railway tracks and roads are not exposed to the same natural perils. e.g. floods). <p>Mitigating measures for the other plants processing alumina (smelters), solid aluminum (rolling mills) and hot aluminum (downstream aluminum) would consist of:</p> <ul style="list-style-type: none">• Purchasing feedstock on the market resulting in an ICoW that could reportedly represent in some cases a reduction of margin and limit the grade range of products (hence a quality issue). It was estimated that in some cases this could represent around # 30% of the BI loss.
--	--





	<p>Major loss at the refinery resulting in alumina supply disruption:</p> <p>Any major loss at the refinery can disrupt the delivery of alumina to the smelter. This could result in induced BI for the smelter and the bauxite mine (in case of interdependencies between sister plants of the same group) or contributing CBI for the smelter and recipient CBI for the mine (the refinery belonging to a different group).</p> <p>The smelter could operate partially (with an alternate source of alumina or using buffer storage) or might have to shut down until the alumina supply is restored. In the latest PD and BI for restoring cells, a Controlled Shut Down should be expected (see Aluminum Smelter section for details).</p> <p>Downstream aluminum could also be impacted i.e. the rolling mill not receiving the required amount of solid aluminum products or other aluminum product factories not receiving the required amount of hot metal from the smelter (as it is only partially operating or shut down entirely).</p> <p>Mitigating measures for the Smelter would consist of:</p> <ul style="list-style-type: none">• Diversifying the supply of alumina thanks to a contract settled in advance with other refineries and securing the contract by having some quantities regularly delivered. Trying to settle an initial contract when the disruption is actually happening would be complicated and result in delivery delays (reportedly 1-2 months) especially for the amount required (alumina is available on the market but providing a large amount in a relatively short time may be an issue). <p>Mitigating measures for the other plants processing alumina (Smelters), solid aluminum (Rolling Mills) and hot aluminum (Downstream Aluminum) would consist of:</p> <ul style="list-style-type: none">• Purchasing feedstock (alumina) and solid aluminum on the market resulting in an ICoW that could reportedly represent in some cases a reduction of margin (difference in production and transportation costs) and limit the grade range of products (a quality issue when processing solid aluminum). It was estimated that in some cases this could represent around # 30% of the BI loss. <p>Mitigating measures for the Mine:</p> <ul style="list-style-type: none">• Redirecting the production to another refinery (ICoW due to transportation)
--	--

	<p>Major loss at the smelter resulting in solid aluminum / liquid hot aluminum supply disruption:</p> <p>Any major loss at the smelter can disrupt the delivery of solid aluminum products and/or liquid hot metal to the Aluminum Downstream. This would result in induced BI for the rolling mill, refinery and the bauxite mine (in case of interdependencies between sister plants of the same group) or contributing CBI for the rolling mill / aluminum products factory and recipient CBI for the refinery and the mine (the refinery and the mine belonging to a different group).</p> <p>Mitigating measures for the Aluminum Downstream would consist of:</p> <p>Diversifying the supply of solid / liquid hot aluminum (when possible) thanks to a contract settled in advance with other smelters and securing the contract by having some quantities regularly delivered. Trying to settle an initial contract when the</p>
--	---



	<p>disruption is actually happening would be complicated and result in delivery delays especially for the amount required.</p> <p>Mitigating measures for the Refinery would consist of:</p> <ul style="list-style-type: none">• Re-directing alumina on the market resulting in an ICoW that could reportedly represent in some cases a reduction of margin. It was estimated to be about 30% of the BI loss in some cases.
--	--

	<p>Major Loss at the Rolling Mill / Aluminum Products Factory:</p> <p>A major loss at the rolling mill / aluminum product factory would result in recipient CBI at the smelter which is no longer able to deliver solid aluminum and liquid hot metal to the Aluminum Downstream.</p> <p>Mitigating measures for the Primary Aluminum would consist of:</p> <ul style="list-style-type: none">• Producing more solid or more liquid hot metal aluminum depending on the product used by the impaired Aluminum Downstream when possible. This would be dependent on the Cast House production capacity and/or the handling capacity of the liquid hot metal users.• Re-directing solid aluminum / liquid hot metal to other plants resulting in an ICoW that could reportedly represent in some cases a reduction of margin (difference in production and transportation costs) and limit the grade range of products (a quality issue when processing solid aluminum). It was estimated to be about # 30% of the BI loss in some cases.
---	---

	<p>Major Failure of Utilities (power / water):</p> <p>Utilities may be part of the shared services within an aluminum complex including Primary Aluminum and Aluminum Downstream plants or may be totally independent (utility providers).</p> <p>A major loss at those utilities may result in induced BI (in the case of interdependencies between sister plants) or Service Interruption (SI – in the case of independent utility providers) for all plants in the complex.</p> <p>In the case of a major loss involving the electric power supply (i.e. loss of the main substation) this would result in:</p> <ul style="list-style-type: none">• Pot freeze at the reduction plant with the smelter having to be shut down for several months.• At least 4-6 months BI (i.e. loss of the main substation) and up to 18 months (i.e. catastrophic loss at the captive power plant) would be expected for all plants in the complex.• Once electric power is restored, all plants of the complex would be back in operation.• Should the power be restored in less than 18 months, the pot freeze recovery of the smelter would not be completed. In the meantime, the refinery would have to redirect alumina to other smelters, and downstream plants would have to purchase raw material on the market (loss of margin # 30% of BI). <p>In the case of a loss involving the process / cooling / potable water (i.e. desalination plant / reverse osmosis) all plants in the complex may be impacted but the severity may be different.</p>
---	---



<p>In the case of power plants including combined cycle GTs/STGs, the gas supply may be an issue. A single supplier or single gas main may represent a serious bottleneck.</p> <p>Mitigating measures for electric power supply failures may consist of:</p> <ul style="list-style-type: none">• For power failure: having a robust power supply including redundancies and spare capacity. This could include, in order of preference:<ol style="list-style-type: none">1. Having a captive power plant (combined cycle GTs/STGs) and full backup by the national grid.2. Having several captive power plants (i.e. different pot line power supplies) with spare capacity and some backup from the grid, providing overall full backup.3. Having well-separated feeders from substations other than from the grid (loop arrangement) with 100% backup capacity. <p>Mitigating measures for process / cooling / potable water supply may consist of:</p> <ul style="list-style-type: none">• Developing a Business Continuity Management / Plan (BCM/BCP): Having sufficient buffer storage on site providing time for arranging an alternate water supply (e.g. road tankers) for critical units, thus avoiding or limiting BI.• Providing full redundancy (two well-separated water sources) <p>Mitigating measures for the gas supply may consist of:</p> <ul style="list-style-type: none">• Providing full redundancy (two well-separated gas supplies)
--

<p>F</p>	<p>Major Loss impacting the import / export facilities:</p> <p>Import / export facilities (load handling, storage) may be part of the shared services within an aluminum complex including Primary Aluminum and Aluminum Downstream plants or may be totally independent (i.e. a service provider).</p> <p>A major loss at those import / export facilities may result in induced BI (in the case of interdependencies between sister plants) or Service Interruption (SI)/CBI/CTE (in the case of independent service providers) for all plants of the complex. Mitigating measures should be investigated as part of a BCM/BCP as listed below:</p> <p>Bauxite – from Mine to Refinery:</p> <ul style="list-style-type: none">• Bauxite ore can be delivered from the mine to the refinery by cross country rubber belt conveyors (mostly above ground), rail cars, trucks or even ships between continents, depending on distance, (third party or owned and operated by the aluminum company). Any event having an impact on rail, road or a port blockage (a sunken vessel in the port or a major loss on a single un-loader) can disrupt the delivery of bauxite to the refinery. This would result in induced BI for the refinery (in the case of interdependencies between sister plants of the same group) or Contributing CBI for the refinery (the mine belonging to a different group).• Mitigating measures for the refinery would consist of:<ol style="list-style-type: none">1. Having a buffer storage of bauxite ore giving enough time to organize point 2. below.2. Having alternate transportation with the highest level of redundancy as possible (i.e. in some cases this could be a combination of cross country conveyors, sprinklers on conveyors, rail and road, and even alternate ports providing up to 100% backup. The Increased Cost of Work (ICoW) must be taken into consideration.
-----------------	---



Alumina – from Refinery to Smelter:

- Alumina produced at the refinery can be delivered to smelter(s) by captive rubber belt conveyors (inclined, covered, elevated), rail cars (dumpers at refinery), trucks or even ships between continents, depending on distance, (third party or owned and operated by the aluminum company). Any event having an impact on rail, road, or a port blockage (a sunken vessel in the port or a major loss on a single un-loader) can disrupt the delivery of alumina to the smelter. This would result in induced BI for the smelter and the bauxite mine (in case of interdependencies between sister plants of the same group) or Contributing CBI for the smelter and recipient CBI for the mine (the refinery belonging to a different group).
- Mitigating measures for the smelter would consist of:
 1. Having a buffer storage of alumina giving enough time to organize point 2. Below.
 2. Having alternate transportation with the highest level of redundancy as possible (i.e. mobile conveyors, sprinklers on conveyors, rail and road and even alternate ports or backup un-loaders providing up to 100% backup. The Increased Cost of Work (ICoW) must be taken into consideration.

Solid Aluminum from the Cast House / Liquid Hot Metal from the Reduction Plant to the Rolling Mill / Aluminum Products Factory:

- Solid aluminum produced at the cast house of the smelter can be delivered to the rolling mill and other aluminum product factories by rail car, trucks or even ships between continents, depending on distance, (third party or owned and operated by the aluminum company). Any event having an impact on rail, road or a port blockage (a sunken vessel in the port) can disrupt the delivery of solid aluminum products to the Aluminum Downstream. This would result in induced BI for the rolling mill, refinery and the bauxite mine (in case of interdependencies between sister plants of the same group) or Contributing CBI for the rolling mill / aluminum products factory and recipient CBI for the refinery and the mine (the refinery and the mine belonging to a different group).
- Liquid hot aluminum produced at the smelter is usually delivered to the Aluminum Downstream (i.e. aluminum product factories) using Metal Transport & Tilting Vehicles (MTTV) over a relatively short distance and usually using private industrial roads (preferable to public roads). Any event having an impact on the access roads can disrupt the delivery of liquid hot aluminum to the aluminum products factory. This would result in induced BI for the refinery and the bauxite mine (in case of interdependencies between sister plants of the same group) or Contributing CBI for the aluminum products factory and Recipient CBI for the refinery and the mine (the refinery and the mine belonging to a different group).
- Mitigating measures for the Aluminum Downstream would consist of:
 1. Having a buffer storage for solid aluminum products giving enough time to organize point 2 below.
 2. Having alternate transportation with the highest level of redundancy as possible providing up to 100% backup. The Increased Cost of Work (ICoW) must be taken into consideration.



	<p>Supply of other Raw Materials:</p> <ul style="list-style-type: none"> • Raw Materials include, but are not limited to: <ul style="list-style-type: none"> - For the refinery: Caustic - For the smelter: Pitch / Coke / Cryolite - For the recycling unit: Aluminum Scrap • Any event having an impact on rail, road or a port blockage (a sunken vessel in the port, a major loss on a single un-loader) can disrupt the delivery of the above raw materials to the dedicated processing plant. This would result in induced BI for these plants and between these plants (in case of interdependencies between sister plants of the same group) or Contributing CBI (the processing plants and the import / export facilities belonging to a different group).
--	---

3. LOSS ESTIMATE CONSIDERATIONS

Acronyms & Definitions

Primary Aluminum and Aluminum Downstream processes exist in a very complex environment due to potentially very strong interdependencies or induced BI, Contingent Business Interruption – CBI / CTE – Contingent time Element and/or Service Interruption, depending on the supply chain arrangement as described in the previous section.

As a result of the above, various loss estimate terminologies and definitions may be used by different (Re)-insurance companies, brokers or risk managers depending on their risk appetite. The main acronyms and definitions commonly used on the market are listed below:





4. SCOR LOSS ESTIMATES

In terms of loss estimates at SCOR only MPL and NLE are considered, as explained below. There is no leeway for using any other acronym or definition (i.e. EML, PML, etc.).

4.1. Maximum Possible Loss (MPL)

The MPL – Maximum Possible Loss – is the estimate in monetary terms of the largest loss which can be expected as a consequence of an insured event. It corresponds to the worst-case scenario after due consideration of all possible events or combination of events, in particular:

- **Fire:** all fire protection systems are inoperable, manual fire-fighting efforts are ineffective and fire can only be stopped by an impassable obstacle or by the lack of continuity of combustible materials (See MPL Handbook for details for minimum separating distances and MPL fire wall definition).
- **All Other Losses:** all possible scenarios must be considered in addition to fire and explosion, in particular, natural perils (earthquakes, storms, floods), civil commotion and man-made catastrophes.

For the explosion scenario in petrochemical-related industries, the in-house Extool (former Explan) software program is used to determine the damage following a Vapor Cloud Explosion.

The MPL calculation includes PD, BI and interdependencies between sister plants where relevant. Neighboring exposure and CBI should be included in the scenario where relevant. However, they should not be considered for the MPL calculation. (See SCOR GAL, Group Accumulation Liability).

4.2. Normal Loss Expectancy (NLE)

The NLE is the consequence of an accident which occurs when all the loss-limiting systems provided to minimize the consequences of that accident function to achieve the results intended. An assessment should be based on a single fire event unless another greater relevant exposure exists.

4.3. Loss Estimates used for the current document

In order to make it simple, only the following acronyms and definitions will be considered in this document:

- **Maximum Possible Loss** (SCOR definition above – systematically given)
- **Estimated Maximum Loss** (Market definition as per section 3 – mentioned when needed) (*)
- **Probable Maximum Loss** (Market definition as per section 3 – mentioned when needed)
- **Normal Loss Expectancy** (SCOR definition above - systematically given)

(*) EML is widely used by the insurance market and the definition may differ between Insurers and even Brokers. In some cases, the EML can be even less conservative than the PML (see Loss Estimate for Alumina Smelter Focus)



5. MITIGATING MEASURES – CP, BCP/M

5.1. Terminology & Definition

There is usually much confusion concerning terminology used when referring to the Contingency Plan, Business Continuity Plan or Management / Disaster Recovery Plan. Giving one standard definition would be very difficult as almost all industrial sectors have their own. The two most common definitions are given below for information:

- **Contingency Plan (CP):** The purpose of a CP is to mitigate the consequences of a potential loss in terms of Business Interruption in the case of a loss of a critical utility or piece of machinery /equipment or sub-process unit. This contingency plan should be established taking all the critical facilities into consideration, such as process machinery & equipment, electrical rooms, transformers and lubrication oil groups. This is particularly suitable for self-sufficient sites located in remote locations.
 - All critical facilities, machinery and equipment should be identified.
 - The availability of all critical spare parts should be defined. Critical spares with a relatively long lead time should be available on site.
 - Machinery and equipment representing severe bottlenecks should be duplicated and stored or installed in separate fire areas.
 - In the case where duplication and/or separation are impossible, adequate protection should be installed.
- **Business Continuity Plan (BCP):** The BCP goes beyond the usual contingency or recovery plans. An organized BCP requires a continuous risk review top-down or bottom-up with the full support and commitment of top management as resources have to be assigned, aligned or re-aligned, such as the case may be. Business interruption could be related to an earthquake, a severe storm, a fire, power outage over a wide area or the complete inaccessibility of a facility for an extended period of time. It should be clear that the cause of the interruption is not important. What is most important is Management's ability to take control of the interruption. This is particularly suitable for sites with multiple interdependencies between sister plants and/or highly dependent on suppliers / customers.
 - Within a BCP, the above existing Contingency Plan should be extended to a scenario-based major disaster, such as the total loss of one processing unit or an event impacting several plants in a relatively wide area (e.g. earthquake, hurricane).
 - The possibility of the partial recovery of the activity, inside and outside the group, should be investigated.
 - The potential interdependencies with the sister plants, upstream and downstream, should be seriously considered.

Note:

- Business Continuity Management – BCM – is also used instead of CP and or BCP.
- Disaster Recovery Plan was originally used for IT systems but is widely used now.

At the end of the day, the main purpose of these mitigating measures is to ensure Management's ability to take control of the interruption.

In order to prevent any confusion in this document, BCP is used at the level of a group when one single event can impact different plants/entities (holistic view). The term CP is used at the level of a given plant/entity (site view).



5.2. Reliability Issues

In actual fact, it is difficult or virtually impossible, to make a CP, BCM/P fool-proof or fail-safe meeting all the following criteria considering that conditions may change over time (i.e. Management, organization, priorities, etc.):

- Consider all possible scenarios
- Avoid over-estimated back-up (CP) and/or resilience (BCP) capabilities
- Implement formalized documentation
- Organize regular testing
- Review, update, upgrade documents when needed
- Ensure leadership (who is responsible for what & when?)

As a result of the above CP, BCP/M are:

- Often designed as an a-posteriori disaster Supply Kit.
- But not everything can be done “by the book”.
- Not always expecting the unexpected.
- Not always ensuring companies can easily adjust to major shifts in markets or operating conditions

5.3. When to consider a CP, BCP/M

Contingency Plans, Business Continuity Management / Plans are not considered when dealing with worst-case scenarios (Maximum Possible Loss -MPL) for two main reasons:

- Philosophy: looking for the worst case including very adverse conditions (conservative approach)
- Lack of reliability (see above)

Depending on the level of confidence in the CP, BCM/P, it can be considered to some extent (use risk engineering judgment) for other loss scenarios (e.g. PML, NLE).

Regarding Contingency Plans (CP) as per the definition given above (i.e. loss of a critical utility, machinery, sub-process unit), a CP can be considered for loss estimate considerations including the Worst Case (i.e. Maximum Possible Loss - MPL) when it is about duplication and to some extent about redundancy and spare capacity, as detailed below:

- **Duplication:** two sub-units are duplicated so that in the case of a loss of one unit there will not be any critical disruption in the process. This could consist of:
 - Two operating sub-units (so-called hot sites in IT), such as two PLC servers or two independent substations feeding the site on a loop.
 - Two sub-units, one on duty and one on standby (so-called cold site in IT), with the standby unit taking over in case of failure of the usual unit on duty. This could take some time should a manual transfer and/or synchronization be needed (e.g. for power generating units reaching full load or national grid connections using Automatic Transfer Switches - ATS).
 - Note that for reliability, when possible, the duplicated units should be well separated and segregated at least from a fire and explosion standpoint but also from a natural perils and exposure standpoint (e.g. flood). Any potential single failure point upstream or downstream of the duplicated units should be clearly identified and eliminated.
- **Redundancy:** the way to express the redundancy level has evolved over recent years as follows:
 - Up to a recent past: N+1 meant that N units on duty were able to run normal operations and that there was one more unit available.



- Today: N-1 is used instead of N+1. This means that even with one unit out of order the operations still run normally.
 - The above N+1 and N-1 (e.g. transformers) means the same: there is one more unit online available that could take over in case of failure of the unit on duty.
 - Note that the main purpose of N+1 / N-1 redundancy is for maintenance: one unit can be taken offline for maintenance and replaced by the N+1 unit.
 - Note that maintenance may necessitate a major overhaul or refurbishment of one unit. In some cases, this could take several months as it could include dismantling and shipping overseas (e.g. a major overhaul of ST/GT rotors, transformers).
 - Based on the above, in the case of the loss of one operating unit while the other unit is offline for maintenance, the related process unit may have to reduce production or even shut down.
 - As a result, any reliable redundancy should include N+2 /N-2 units: one standby unit allowing for maintenance and one more unit providing full back up for any one unit. This could be done in the form of a “swing” for Rectifier Transformers (RTs) by having two pot lines on the same smelter (see Reduction Plants).
 - Note that for reliability, when possible, all units should be well separated and segregated at least from a fire and explosion standpoint (e.g. transformers separated by blast walls) and from a natural perils and exposure standpoint (e.g. flood).
- **Spare capacity:** some units may have spare capacity (e.g. a Gas Treatment Center dedicated to pot room A that could handle 50% of the gas emitted by the nearest pot room B in case of failure of its GTC). This spare capacity may be considered for the Loss Estimate scenarios as follows:
 - Two units with spare capacity and physically connected to each other so that one unit could partially or fully provide (depending on the spare capacity level) in reasonable time without generating a major disruption. This could be considered for the NLE and even the MPL when well documented.
 - Note that for reliability, when possible, all units should be well separated and segregated at least from a fire and explosion standpoint (e.g. minimum separating distance between GTCs avoiding mutual exposure in case of fire / explosion) and from a natural perils and exposure standpoint (e.g. flood). Any potential single failure point upstream or downstream of the duplicated units should be clearly identified and eliminated.



III - BAUXITE MINE FOCUS

1. PROCESS

The most common way to mine for bauxite is by using open pit mines.

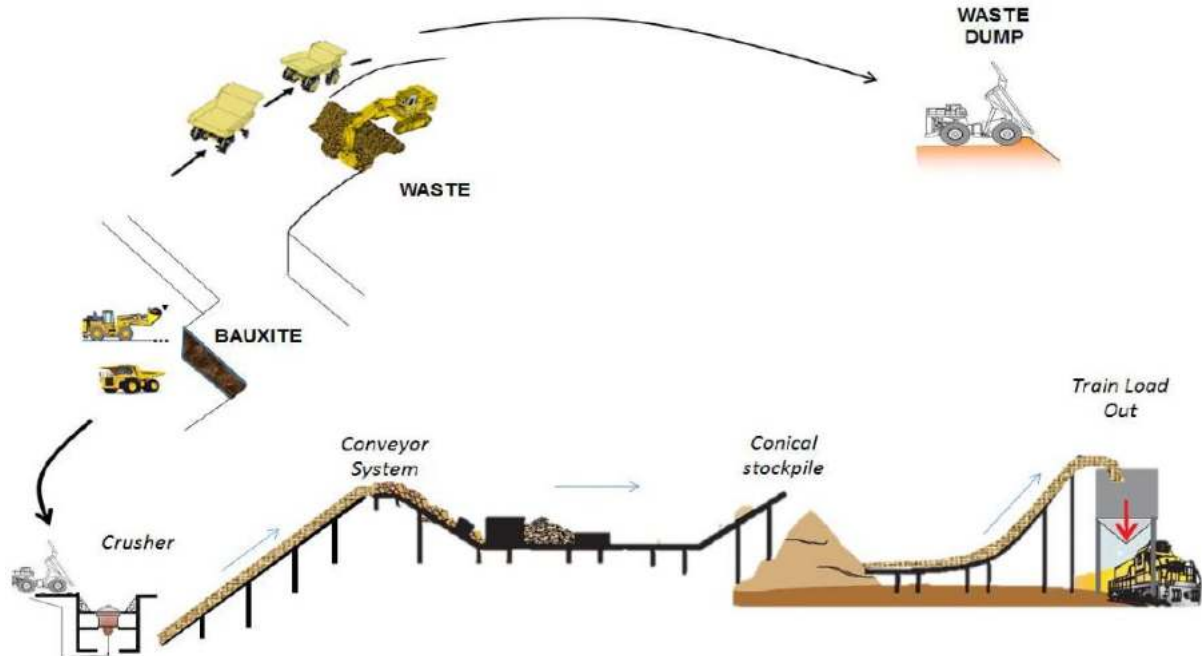

Process flow diagram

Courtesy of Virtual i Technologies Ltd, Risk Engineering Service Provider for Aon in the Middle East

There are also some places where aluminum ore has to be mined from deep underground.

2. SPECIAL HAZARDS & RISK CONTROL

Special hazards, prevention, protection and potential mitigation measures are detailed below for each and every special hazard related to this occupancy (following the process flow from the Raw Material to the Finished Product as much as possible). Related recommendations are also mentioned "(see. Rec)". Please refer to section 11. "Support for Loss Prevention Recommendations" for details.

2.1. Mines

Open Pit Mine:

- Surface mine / Open cast mines are potentially vulnerable to bench failure and landslides. The collapse of a haulage road can lead to the loss of access to the pit.
- Special equipment is used to cut one layer after another off the surface, within the rock, before transporting elsewhere for further processing.



Underground mine:

Underground mines can be relatively deep (e.g. Cheremkhovskaya-Deep mine in the Urals in Russia, whose shafts run 1,550 m deep).

Prevention & Protection:

Open Pit Mine:

- A geotechnical review should be conducted by external consultants during the original mine design. Additional geotechnical reviews should be conducted when the mine pit goes deeper.
- Regular (e.g. daily) surveys of mine pits should be conducted to check ground stability.
- In some cases, fixed equipment should be installed to monitor any earth movement (IR/GPS/radar). This is especially necessary in active seismic zones.
- Slope & bench failure considerations: i.e. with mine pit benches of around 50 m wide and 4 m deep, the mine pit is deemed as still too shallow to warrant additional geotechnical reviews.
- Drainage networks should be designed in accordance with a flood study taking into consideration both surface water run-off and accumulation of rain water.

Underground Mine:

Underground mines can be relatively deep (e.g. Cheremkhovskaya-Deep mine in the Urals in Russia, whose shafts run 1,550 m deep).

For relatively shallow UG mines, a haulage road can be used for vehicle access.

Access is usually done through a shaft for very deep underground mines.

Depending on the type of rock ore extraction, the processes can be different:

- Soft rock: neither drilling nor blasting
- Hard rock: drilling & blasting



UG facilities may include:

- UG crushers, workshops, cooling plants, backfill plants, mid-shaft loading, hydropower systems, diesel fuel supply for vehicles, substations including transformers
- UG mobile equipment (trains, remote-controlled in unstable areas)
- UG dewatering facilities



Prevention & Protection:

Courtesy of a South African former mining contractor:

The following points are critical:

- Good hoist conditions, maintenance
- At least two shafts: 1 vent shaft / man and 1 material shaft (better than 1 single rock hoist mine in case of shaft collapse)
- Monitoring of noxious / toxic gases (if any)
- Monitoring of water / mud in rush due to breach of aquifer, trapped water pocket
- Adequate support methods (if any) and monitoring (collapse potential)
- Backfill method (if any)
- Prevention of rock burst (if any)
- Fixed fire protection of fuel supply, electrics (prefer dry-type transformers)

The next points will focus exclusively on surface mining.



2.2. Drilling and Blasting

Blasting is usually done several times (e.g. 4-5) per week using Ammonium Nitrate Fuel Oil (ANFO. e.g about 5-10 tons of explosives used per blast) in sections (e.g. 50 m x 100 m) of the bauxite rock for handling and crushing. The ANFO explosives are usually supplied by a third company (several ton deliveries) by road and under police escort to be stored on site.

Prevention & Protection:

- The storage compound should be located sufficiently far away from the mine. Usual adequate measures for mitigating the possibility of an explosion blast destroying all storage consists in having at least two explosive magazines and one storeroom for detonators arranged in a triangle formation, with at least 150 m between stores. A security system is key and should include access control and perimeter supervision.
- In some cases, the local police is present for all detonations and they control all access to the explosives storage compound. Blasts are controlled by a blast work order report.
- Having back up for drill rigs is good practice (e.g. two drill rigs for blasting, with only one normally required for blasting operations).

2.3. Waste Handling

- All overburden mined out of the ore tops is usually dumped in in-pit dumps.

Prevention & Protection:

- A horizontal distance (around 50 m) should be maintained between the mining area and the backfill waste dump to help prevent any slippage impacting the mining operations.

2.4. Bauxite Ore Handling

Run of Mine (ROM) Stockpile Management:

- ROM Stockpiles (if any) describes any of the run of mine stockpiles of bauxite ore (as periodically designated by ore type and grade by the Owner) that are located in the Primary Crusher area.
- Effective stockpile and ROM management means getting the right product delivered in the right volume, to the right specifications and at the right time.
- The bauxite ore is usually blended in/near the mine pit by the crusher in order to meet the required grade for processing at the refinery. Core samples are usually taken and tested in the on-site laboratory or by a third party laboratory, when available.

Prevention & Protection:

- Dust control throughout all of the pit area should be provided when trucks operate. Adequate visible road signs (sufficiently large to be visible) and regular cleaning should be provided. All structural frame-supporting equipment should be protected from mechanical impacts (e.g. trucks).

Crushing (e.g. using two stage sizers):

- Bauxite is received by haulage truck and dumped from an elevated earthworks pad into an aboveground hopper. An apron feeder draws the material from the hopper at a controlled rate and feeds it into the first of two twin screw-sizing machines. The mined bauxite is generally up to 1,500 mm in dimension and is reduced to a size of around 500 mm by the primary sizer and then to 250 mm by the secondary sizer. Fine material passing through the plates of the apron feeder is collected by an integral dribble belt conveyor, which discharges to the sizer feed.
- The two sizers (e.g. Abon-FLSmith with a capacity of 1,800 mt/hr each) are usually stacked one above the other with a short interconnecting chute.



- The secondary sizer discharges to the stockpile conveyor, which elevates the bauxite and discharges to a conical stockpile of bauxite over a reclaim vault.
- The crushing equipment usually only operates when there is capacity in the stockpile to receive material. This normally occurs when the stockpile is depleted following loading of a train. The stockpile can take several hours (e.g. 15 hours) to be replenished based on normal operating rates of the crushing and stockpile conveying equipment. This, reportedly, can usually be reduced (e.g. to around 10 hours) if the equipment is operated nearer to its design capacity.

Prevention & Protection:

- The wall retaining the elevated earthworks pad should be adequately designed and regularly inspected in order to prevent any catastrophic collapse that may also damage the crusher.
- Any hydraulic group (if any) should be protected with fixed fire protection systems and interlocks, or FM-approved less combustible fluids should be used (see Rec.)
- The sizers should be interlocked with the operations of the overland (cross-country) conveyor (if any). Operations should also be automatically shut down should the secondary sizer stop.
- Water spray, to control dust generation, should be provided around the dump hopper and should normally operate during haul truck unloading. Dust should be cleaned from the crusher on a regular basis (e.g. twice a week in dusty environments such as sandy deserts).

Conveyor Systems & Stockpiles:

- The overland (cross-country) conveyor can transport crushed ore over several kilometers to the inclined and elevated stockpile conveyor. The take-up is usually a simple gravity arrangement, integrated into the structure for the ground-level drive pulley.
- The stockpile conveyor usually discharges the ore onto conical stockpiles (e.g. maximum capacity of 77,000 tons, with a height of 28.5 m).
- Trucks are loaded from the stockpile by a Wheel Loader.
- For the trains and the reclaim, there is a vault under the stockpile house. Apron feeders draw bauxite down from the stockpile via slots and chutes formed in the top of the concrete vault. Sophisticated modern reclaim apron feeders are usually provided with electro-mechanical drives equipped with variable speed control.
- The feeders usually discharge to a common conveyor that transports the bauxite to the Train Truck Load Out station (TLO). The take-up is a simple gravity arrangement, integrated into the structure for the ground level drive pulley. At the head end of the TLO conveyor, a primary sample cutter may be installed. This discharges to a sample process that involves two stages of crushing and additional sample division. The process produces a sample of material suitable for further laboratory analysis.

Prevention & Protection:

- The height of the stockpile should be monitored with adequate and reliable systems. This can consist of an ultrasonic and fixed contact switch located at the end of a rope hanging from the top of the conveyor.
- Replacement of the entire conveyor belt should be planned during a major overhaul (e.g. taking around 3-4 days and 500 m of belt length to be replaced). Spare belts and repair capability should be available on site.



- Any ferrous material should be removed before the stockpile. An adequate system can consist of:
 - Having an electromagnetic trash magnet positioned over the stockpile conveyor and
 - A metal detector positioned downstream of the magnet. This will trip the conveyor and upstream equipment if any ferrous material passes the magnet, thus enabling manual removal of the trash.
- The conveyors should be provided with a manual pull wire, belt rip detection and interlocks, belt misalignment interlocks, belt bulge detection and motion sensors to shut off the drive power when the belt stops or slows down by more than 20% of the normal speed. Conveyor bearings and drives should undergo routine maintenance which includes monitoring the bearing temperatures during operations. Belt overload sensors should be installed.
- Fixed fire protection systems for the conveyors (e.g. wet pipe sprinkler or deluge) should be installed, at least in the concrete bunker section of the conveyor below the ground and on the open section above ground, for the inclined and elevated sections of the conveyor. Activation of the deluge system should be interlocked to shut down the conveyor. The elevated section of the open conveyor is usually constructed using open steel grate flooring on a steel frame and supported by steel columns. During a fire, these steel structures will rapidly lose their integrity and collapse. Safe and efficient manual firefighting would be virtually possible (See Rec. section 11).
- Dust control should be provided when trucks operate. Adequate visible road signs (large enough to be visible) and regular cleaning should be provided. All structural frame-supporting equipment should be protected from mechanical impacts (e.g. trucks).

Truck and train loading can be done in various ways using mobile equipment and/or fixed sophisticated structures and systems:





Train Load Out (TLO):

- Bauxite is loaded onto train wagons at the Train Load Out station. The discharge from the bin is usually controlled by a volumetric feed system, which uses a load boot and flow control gate. The train travels through the station at a fixed speed, and wagon-sensing devices trigger the loading boot control gate. This floods the wagon and loads for a pre-determined time, before shutting off the flow until the next wagon is in position. The flow control gates are usually powered using a hydraulic oil system (e.g. 1,700 L of petroleum-based hydraulic oil).



Train Load Out

Courtesy of Virtual i Technologies Ltd, Risk Engineering Service Provider for Aon in the Middle East



- Trains are either operated by the mining company or by a third party. Trains can be loaded daily (e.g. 115 wagons each with a 100-ton capacity).



Prevention & Protection:

- The hydraulic group powering the flow control gates should be adequately protected with a fixed fire suppression system and interlocks should be provided, or FM-approved less combustible fluids should be used (See Rec.).
- The load in the train wagons should be measured and a safeguard should be provided for preventing overloading of the wagon. This could consist of:
 - Load measured by load cells located under the rails.
 - An excavator arm and bucket mounted downstream of the load point to trim any overloaded wagons.
- Dust emission should be controlled at the level of the TLO when the bin is filled (e.g. a bin vent filter eliminating emissions of dust with displaced air when the bin is filled).
- Dust control of roads should be provided when trucks operate. Adequate visible road signs (large enough to be visible) and regular cleaning should be provided. All structural frame- supporting equipment should be protected from mechanical impacts (e.g. trucks).

2.5. Mobile Mining Equipment and Related Facilities

- A fleet of mobile plant equipment can be:
 - owned and operated by the mining company
 - owned by the mine and operated by a third party
 - owned and operated by a third party
 - a mix of the above





- Mining equipment usually includes:
 - excavator
 - wheel loader
 - haulage Trucks (e.g. 91 ton capacity)
 - water Trucks (e.g. 80 m³ capacity for dust control)
 - dozer
 - grader
 - blast drills
 - RC grade control drill
 - etc.
- The value of each piece of mobile equipment can reach several millions (from 1 to 8 MUSD)
- A Workshop is used for servicing the mobile plant equipment such as service trucks, loaders and forklifts. A single building can house several vehicles (e.g. 4-8 vehicle bays housing general vehicles, tires and fabrication/welding workshops).
- The following facilities are usually installed in close proximity to the workshop:
 - Diesel oil supply for mobile equipment
 - Oil supply, used oil, hydraulic supply, used hydraulic fluid for mobile equipment
 - Critical spares for mobile equipment, usually stored in a warehouse located at the mine site
 - Large consumable parts such as tires, usually stored in a yard

Prevention & Protection:

- The mobile mining equipment at the mine should be parked (when not operating) in more than one area, at least 40 m apart, in order to divide the risk and to avoid the loss of several expensive vehicles in case of fire.
- Adequate and approved onboard fixed fire suppression systems should be installed on critical mobile equipment. These fire-protection systems should be designed to protect the most hazardous locations such as (but not limited to) engine compartments and hydraulics. Both automatic and manual activation should be provided.
- Workshop building construction material should be of the non-combustible type and adequate manual firefighting equipment should be provided in case of fire on a piece of mobile equipment while in the bay. For combustible constructions (e.g. PUR, PIR insulated panels) the building should be sprinkler-protected in accordance with NFPA. EPS insulated panels should not be permitted on the ceiling.
- Overhead cranes should be adequately parked and detected / protected when needed, as recommended in section 11.
- The diesel oil supply for mobile equipment should be located at least 40 m from any facility. See section 11 for Ignitable Liquid Storage Tank protection.
- The facility housing the oil supply, used oil, hydraulic supply or used hydraulic fluid for mobile equipment should be well separated from any other facilities (i.e. 40 m from the workshop, spare parts warehouse) or, if installed against / close to the workshop, adequate passive protection (i.e. fire wall, 2-hour fire-rated partition) and sprinkler protection should be provided.
- The decision for providing fixed fire protection (sprinklers) for the spare parts warehouse should be based on a risk/benefit analysis (i.e. value and criticality – lead time - of the inventory). Combustible construction materials (i.e. PIR/PUR insulated panels) warrant the installation of sprinkler protection. Hazmat and compressed gases should be stored and protected in accordance with section 11.



- All vehicle tires should be stored in a detached structure located at a reasonable distance (40 m) from any other facility. Note that in some areas, due to adverse weather conditions, storing the tires outdoors without any precautions would lead to their premature hardening.

2.6. Utilities

Electric Power:

- The mine can be serviced by the national grid using, in most cases, a single overhead line connected to the grid by a single substation.

and/or

- The mine site can be remote from any national grid-based power supply and need to generate its own power supply. In such cases, a diesel Power Generation Plant located on site can provide power to the entire mine site. The power plant can be comprised of skid-mounted diesel-powered alternators (e.g. five x 2.2 MW / 2.75 MVA). Each alternator is usually supplied as a fully integrated skid package, with self-contained radiator cooling, governor, fuel pump, starter motor, associated auxiliaries, ducted air system to minimize the building heat load, and a 24-hour supply diesel fuel day tank located outside.
- Note that the power supply for the mine can also be used for supplying the nearest village (community support), mine village (employees) and bore field (providing water).
- Each unit of the Power Generation Plant and/or the national grid feeder connects to a common bus bar, with HV feeders providing the power supply to all substations of the mine site. Each and every substation consists of an outdoor/indoor transformer, switch gear / MCC cabinet room and a cable cellar such as in this example:
 - Substation 1 (Stockpile Feed) with 2 x 2.5 MVA 4.16/0.48 kV transformers.
 - Substation 2 (Crusher) with 2 x 2.5 MVA 4.16/0.48 kV transformers.
 - Substation 3 (Product Storage / TLO) with 2 x 3 MVA 4.16/0.48 kV transformers.
 - Substation 4 (Mine Administration and Services) with 1 MVA 4.16/0.48 kV transformer and 1 MVA 4.16/0.4 kV transformer.
 - Substation 5 (Bore Field) via 13.8 kV overhead lines with 250 kVA, 13.8/0.48 kV transformer.
 - Substation 6 (Mine Village, Bore Field, Explosives Compound) via 13.8 kV overhead lines with 500 kVA, 13.8/0.48 kV transformer and 2 MVA, 13.8/0.4 kV transformer located outside the Power Plant Building.

Prevention & Protection:

- Prefer a combination of the national grid supply and power plant generation providing at least 100% mutual backup.
- Power Generation Plant:
 - The building construction materials should, preferably, be of the non-combustible type. In case of combustible constructions (e.g. PUR, PIR insulated panels) the building should be sprinkler-protected in accordance with NFPA. EPS insulated panels should not be permitted on the ceiling.
 - The skid-mounted diesel-powered alternators should be adequately protected as per NFPA (see Rec. section 10 Stationary Combustion Engine).
 - Spare capacity should be provided (e.g. N+2 arrangement: under normal load conditions, 2-3 units operate, with one on standby and one offline available for maintenance.)
 - The units should be provided with both battery and air start capability.
 - An integrated automated control system monitoring and controlling the start-up, loading, running, unloading and shutdown of the power station alternators is



recommended for better reliability (optional). This control system provides fully automated functionality for black start operations and automated load regulation.

- The building should have an overhead gantry crane capable of lifting each alternator skid out of position and onto the hard stand area or truck. The gantry crane can be remote pendant controlled, capable of being operated from any location within the alternator room.
- The substations, including transformers and battery rooms (ESS), should be adequately protected as per NFPA (See Rec section 11). Prefer dry-type electrics rather than oil-filled electrics (i.e. breakers).
- IR scanning and DGA for transformers should be regularly implemented (at least once a year).
- Emergency Diesel Engine driven generators should be provided, at least in the following areas, for emergency light and service operations:
 - the explosives compound.
 - the mine village.
 - the village (community).

Compressed Air:

- A compressed air supply, where required, is generally provided by a local air compressor unit rather than a central distributed system. The power plant usually has a dedicated air accumulator, which is charged from the plant compressed air system to facilitate back-up air starting of the alternator diesel engines.

Prevention & Protection:

- Provide an Automatic Fire Alarm inside the compressor hall. (Preferably a heat detector rather than a smoke detector in dusty environments).
- Provide spare capacity (N+1, N+2 units).

HVAC:

- Heating, ventilating and air conditioning (HVAC) is usually designed separately for each building to suit their varying requirements.

Water:

- Raw water from the bore wells (300-400 m deep) is used as process water for dust suppression. The raw water is stored in the large capacity raw water tanks. Dust suppression water is usually pumped (using water pumps) to the bauxite handling equipment area or to a standpipe for water tanker refilling.
- A Reverse Osmosis (RO) water treatment plant can also be located near the Power Plant in order to provide potable water for mine site operations and bauxite handling areas. After treatment, the potable water is stored in a potable water storage tank adjacent to the RO plant and then pumped to users via potable water pumps.

Prevention & Protection:

- Ensure enough buffer storage and spare pumps (N+2) are supplied from the Emergency Power Supply.



2.7. Control System

Different arrangements are possible. The usual one consists of:

- A Central Control Room with a Main PLC Server Room located at the Administration Building. The central control room is mostly for process monitoring but can also be used to operate if required.
- Process control can be SCADA (Supervisory Control and Data Acquisition) system based. Each SCADA station of the process is connected to the PLC rooms which service the Main Server Room.

Prevention & Protection:

- Depending on the arrangement, cyber security and so-called “disaster recovery plans” for IT (i.e. loss of data) should be considered.
- Server room: when redundant servers are provided, they should be located in different areas. If only one server is provided, a Contingency Plan and adequate automatic fire protection system should be provided (See Rec. for electric rooms, section 11).

3. CONTINGENCY / BUSINESS CONTINUITY / RECOVERY PLAN

Warning: in order to be reliable, a Contingency / Business Continuity / Recovery Plan should be formalized. This would include formal contracts signed in advance with vendors and/or third parties. The plan should be regularly tested, reviewed and updated.

Holistic view:

- If the mine is part of a group with a relatively high level of vertical integration in the aluminum industry, a Business Continuity Plan (BCP) at corporate level should be developed for the main identified risks at the level of each and every process unit.
- The effect of a loss impacting third parties (i.e. logistics, utilities) should be investigated and an adequate BCP should be established.

Site view:

- Electrical power, either from the grid or generated at the mine, is critical. Full backup, including separate main substations, would provide adequate duplication.
- If the Power Generation Plant is on site without backup: mine operations are entirely dependent on the power generated on site so there would be total disruption to operations whilst remedial action is undertaken. Replacement of building and power generation equipment would take around 12 months. Depending on the power load required for the site (e.g. around 900 kW) it might be possible in the interim period to hire and bring portable generators on site to provide for the required power demands, along with erecting temporary switchgear equipment. It is usually estimated this would take around 3 months to do.
- The Crusher is one of the main bottlenecks and a major breakdown will have a significant impact on mining. 18 months are needed for replacing a crusher circuit. In some cases, it is reportedly possible to use rental mobile crushers that could be delivered to the site and set up in just a few days, though this is more suited to the loss of one sizer (primary or secondary) rather than the entire circuit. The crushed ore could be moved onto the conveyor system manually. In the meantime, the stockpile inventory (e.g. 8-9 days usually) could be used to provide some bauxite to the refinery.



4. LOSS ESTIMATES

Maximum Possible Loss (Technical MPL – SCOR):

- Catastrophic event at the crusher damaging the structure (e.g. retention wall failure): - 18 months replacement.
- Induced BI should be considered in case of interdependencies with sister plants downstream. This could be mitigated by buffer storage (providing some extra days of production) and alternate suppliers (if any).

Probable Maximum Loss (Market definition): N/A

Note that in terms of loss estimates at SCOR, only MPL and NLE are considered. There is no leeway for using any other acronym or definition (i.e. EML, PML, etc.). EML or PML are only given for information.

Normal Loss Expectancy (NLE – SCOR):

- Fire at the Power Generation Unit: adequate fire protection provided for the diesel generators but not for the building itself, or the lube oil group and combustible roof (PU foam insulated panels). This would result in a total loss (100%) of the power generating unit. 3 months are reportedly needed for installing a temporary power supply (vendors are identified and contracts are established). As a result, 4 months BI would be considered for the entire mine.
- Induced BI, in case of interdependencies with sister plants downstream, should be considered. This could be mitigated by buffer storage (providing some extra days of production) and alternate suppliers (if any).



IV - ALUMINA REFINERY FOCUS

1. PROCESS

Process Overview:

- The industrial process is basically a continuous process processing Bauxite Ore. Depending on the bauxite ore available, different blends can be processed. These can consist of a mix of Gibbsite (“sweet Alumina”. e.g. 105 g/l dilution – 65% of Alumina) and Böhite (e.g. 45 g/l dilution – 85% bauxite).
- The Bayer process is used to extract alumina from bauxite using aqueous caustic soda and can be summarized as follows:

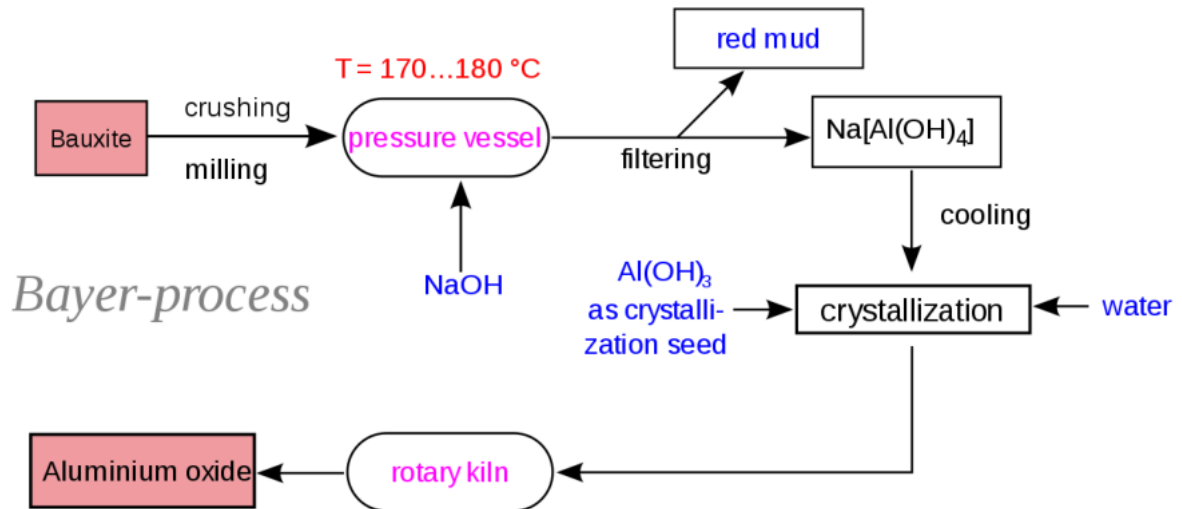

Process Chemistry:

- The Bayer process is based on the reversible reaction of hydrated aluminum oxides with aqueous caustic soda to form sodium aluminate, which can be written as follows:

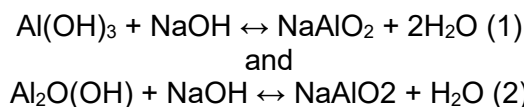

- First, the reactions' equilibria move to the right with increases in the caustic soda concentration and temperature (digestion), then the dissolved alumina is separated from the insoluble impurities of bauxite by physical separation (decantation) and washing, and finally the reaction equilibrium is moved to the left (precipitation or decomposition) with dilution and cooling. The reactions can also be written as follows:

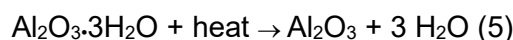
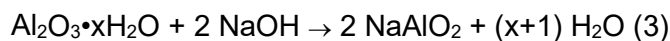

- Equation (3) represents the extraction, or first stage. The hydrated alumina is dissolved by hot, strong caustic soda, while most other ingredients of the bauxite are not solubilized. Then, after separation of the solids (insoluble ingredients or “red mud”), the conditions are adjusted (cooling, dilution of the caustic solution with water) so that the essentially reverse reaction expressed in Equation (4) occurs; this is the decomposition. The tri-hydrated alumina precipitation requires seeding for nucleation. In the last stage,



Equation (5), the tri-hydrated alumina is converted to a mixture of various crystallographic forms of alumina by calcination.

Process Flow Chart (e.g. usual process):

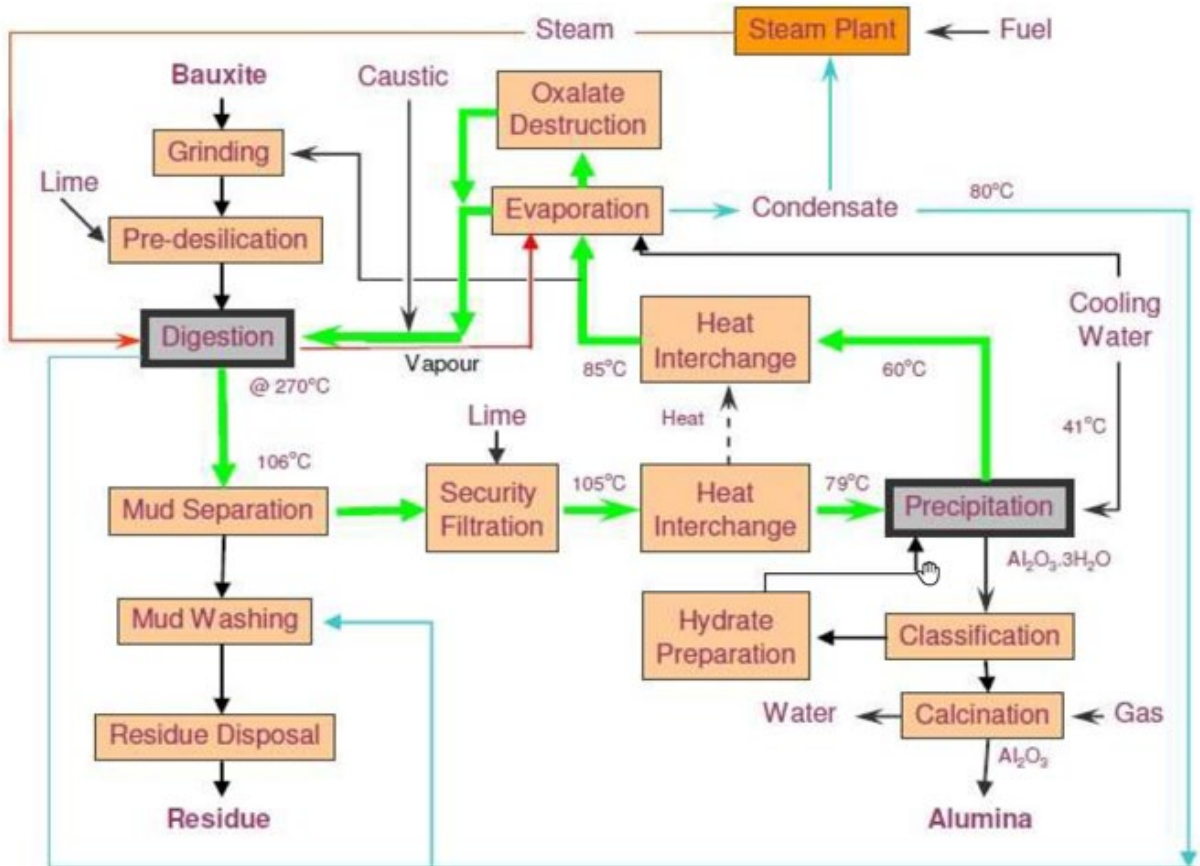

Courtesy of Virtual i Technologies Ltd, Risk Engineering Service Provider for Aon in the Middle East



2. SPECIAL HAZARDS & RISK CONTROL

Special hazards, prevention, protection and potential mitigation measures are detailed below for each and every special hazard related to this occupancy (following the process flow from raw materials to finished products as much as possible). Related recommendations are also mentioned “(see. Rec)”. Please refer to section 11. “Support for Loss Prevention Recommendations” for details.

2.1. Bauxite Ore Handling

Bauxite ore is delivered to the refinery either by ship, train or road and can include the following unloading facilities:

- Ship loader (at the port)
- Train unloading station:



Rotary Car Dumper



(Self) bottom-dump cars (hopper car)

- Truck loading
- Stock pile
- Overland conveyors (potentially covered, inclined, elevated, then underground below the hopper, then above ground up to the stock piles)
- Reclaimers and stackers
- Conveyor belts (potentially side-by-side on the same gantry(inclined, overhead and covered up to the slurry preparation unit

Prevention & Protection:

- In the case of the Rotary Car Dumper, the hydraulic group(s) and the related electric system should be protected, as recommended in section 11. An adequate Contingency Plan (i.e. duplication or alternate unloading system) should be formalized.
- The structural members supporting the overhead conveyors should be protected from any mechanical impacts (i.e. trucks). Covered, inclined, elevated or underground conveyors should be protected, as per section 11.
- An adequate backup should be provided in case of a major loss at the reclaimer or stacker or an adequate Contingency Plan should be formalized.



2.2. Slurry Preparation

Slurry preparation involves:

- Semi Autogenous Grinding - SAG Mills (low-speed rotating equipment, lubricating group and electric driver)
- Slurry is then prepared in dedicated tanks



- Digester feed pump (heavy duty slurry pump - up to 4 080 hp / 3 000 kW up to 1 400 m³/h - and related hydraulic groups involving hydraulic oil under pressure e.g. 300 bars / 4,350 psi)

Prevention & Protection:

- SAG Mills: adequate redundancy should be provided (i.e. from N+1 and above). Lubricating groups should be protected, as recommended in section 11.
- Digester feed pump: adequate redundancy should be provided (i.e. from N+1 and above). Spare drivers should be available. The best arrangement consists of having 2 groups of pumps providing full backup and adequately separated from a fire standpoint. The pump house or canopy (if any) should be made of non-combustible material. Hydraulic pumps should be protected as per recommended in section 11.

2.3. Bauxite Ore Processing (from “red side” to “white side”)

- A typical production unit is comprised of:
 - Digestors (e.g. 3, of which 2 online)
 - Flash drums (e.g. 8, of which 7 online)
 - Blow off drum (1)
 - Precipitation train (1)
 - Calcination unit (1)
- The refinery can be fitted with either low or high-pressure vessels depending on the process type (efficiency-related depending on type of bauxite ore).



- High pressure vessels in the digestion area have the maximum energy release potential. This includes the digesters, heaters, flash tanks and blow-off tanks. Digesters can operate at 200°C at 65 bars and above, with high-pressure steam used for heating. The main risk is the rupture of a vessel leading to the release of a blast wave destroying equipment (see Loss Estimates section).

Note:

- High pressure is usually defined as exceeding 1 bar / 15 psi. Any high-pressure vessel, when over-pressurized, can lead to a catastrophic failure generating a blast wave and consequential damage to its surroundings. The failure can be due to a variety of causes including: 1) blocked or improperly sized vents or pressure-relief systems, 2) a sudden increase of pressure (e.g. runaway reaction), 3) detonation of unstable products (e.g. nitrates, peroxide, ethylene oxide, etc.), 4) a dust explosion inside the vessel.
- Caustic chemical mixture is used in the digestion process (highly corrosive)



Prevention & Protection:

- All equipment should be made of adequate material (i.e. corrosion potential) and adequate thickness (pressurization).
- Adequate maintenance and inspection programs should be run, covering, but not limited to, corrosion monitoring of piping, pressurized vessel inspection and testing (at least every 5 years).
- Positive Metal Identification of material entering the site (prior to warehousing and installation on the field) should be systematically performed, especially for special alloys on pressurized equipment, in order to ensure that proper materials are used (i.e. steel, alloys). This should be part of a Positive Metal Identification procedure that should be established and strictly enforced for all pressurized material made of special alloys. Some plants may rely on certification from the manufacturer. Material made of wrong alloys and installed on pressurized equipment has been responsible for numerous losses within the industry, despite certification. The above-recommended test can be of the non destructive type – nuclear testing – using hand-held equipment or using destructive tests on samples.
- An adequate level of equipment redundancy should be provided. Banks of equipment (if any), working in series in this continuous process, are designed in a way so that any unit



within a bank can be isolated and bypassed at any time without seriously affecting the continuous process. Adequate remotely operated valves should be provided for the isolation of main vessels (i.e. of a fail-safe type when motorized and electrically operated). These isolation systems should be tested regularly up to the very last element (i.e. the valve during Turn Around and Inspection Periods).

- All electric pumps and agitators, maintaining solid material in a liquid phase preventing sedimentation, should be powered by an Uninterruptable Power Supply in case of failure of the main supply (i.e. Diesel Engine Driven Generators starting upon Automatic Transfer Switch operations).
- Adequate in-built safety is required. This includes, but is not limited to, an adequate depressurization system (Pressure Safety Valves - PSV), and a safety interlock for steam injection and slurry feed. Key parameters should be clearly indicated in a comprehensive way in the control room (i.e. PSVs – see note below).
- Adequate containment should be provided consisting of adequate primary (single-walled, double-walled when needed), secondary (curbs, dike retention under vessels and tanks) and tertiary retention (draining network connected to an emergency basin) in case part of the process needs to be drained off.

Note on PSVs:

- Multiple PSVs for the same pressurized equipment inside the process area tend to chatter, losing efficiency and disturbing the proper working conditions of the valves. As a result, a single valve in service in the process area is often preferred (the other PSVs are used as backup).
- PSVs welded directly onto the pressurized equipment are the most reliable, ensuring a constantly operating depressurization system. However, should maintenance be needed, the process unit should be shut down and depressurized.
- A block valve between the pressurized equipment and the PSV would allow the PSV to be isolated for replacement purposes (maintenance).
- In some cases, at least two PSVs and their block valves are installed so that one valve is operating (block valve left open) and one valve is on standby (one valve left closed). In order to prevent both valves being closed (worst case), an interlock system can be used in order to ensure that one PSV is constantly operating. Without the interlock system, all block valves should be locked or sealed (car seal, plastic strip wise, etc.) in their normal operating position and regular (weekly) inspections should be conducted in order to detect any deviations (especially after maintenance / inspection operations).
- In terms of testing, all PSVs should be regularly tested. At least once a year would be recommended as best practice for T&I (Turn Around & Inspection) and at least once every 3 years as per the API (American Petroleum Institution). The PSV should be uninstalled from the protected pressurized equipment, and tested on an approved calibrated test bench (i.e. pre-pop test allowing the detection of any existing deviation before dismantling and conducting further investigations), dismantled and maintained, including replacing damaged equipment and consumables (seals, springs, etc.), and then re-tested on the bench (pre-pop test). Rated operating pressure and current operating pressure should be recorded. Significant deviations should be investigated (clogging, premature metal failure, etc.). Note that in some areas, such as in some countries in Asia, only functional tests are conducted.
- New PSVs should be pre-pop tested on an approved calibrated test bench prior to being installed in the field. The plant should not rely on certificates alone. This is usually done as part of the new equipment Commissioning Testing procedure.
- PSVs that are to be (re-)installed on process equipment should be transported and lifted in their normal operating position (vertical). Any mechanical stress (impact) should be reported and the PSV should be checked and pre-pop tested again prior to installation.
- PSVs should have a name plate with the registration number, rated working pressure and inspection date (to facilitate field inspections).



2.4. Alumina Storage & Handling

- Alumina is usually stored in a warehouse (bulk storage).
- Alumina has an unlimited shelf life, but it has to be stored under the right conditions as it will absorb moisture at the first opportunity, so alumina producers prefer to ship it off to smelters as soon as possible.
- Alumina is:
 - loaded into railroad cars for dispatch to smelters (via harbor for export in some cases). and/or
 - sent to a conveyor running to the silos at the nearest smelter (if any). This is usually done by a system of rolling stackers, reclaimers and hoods inside the warehouse. and/or
 - loaded into road tankers
- In some aluminum complexes, inclined, covered and elevated conveyors can carry alumina from the calcination unit and/or the above storage to the dump point for pick-up by trucks and transport to the nearest smelter silos (buffer storage).

Prevention & Protection:

Alumina being a non-combustible material, only warehouses made of combustible materials (e.g. PU foam-insulated panels) warrant the installation of sprinkler protection. Inclined, covered and elevated conveyors should be protected, as recommended in section 11.

2.5. Utilities

Main utilities include:

Electric Power:

- directly from the national grid (overhead feeder)
- from the national grid but via a sister plant (e.g. nearby smelter through underground or overhead lines)
- from a Captive Power Plant (overhead feeders)
- a mix of all the above
- Distribution on site is usually done by the main substation (main feeders) supplying all process unit substations.
- All substations include transformers, switchgear rooms, MCC rooms, cable vaults

Prevention & Protection:

- Prefer a combination of the national grid supply and a Captive Power Plant providing at least 100% mutual back-up.
- Note that the Captive Power Plant can be the same Power Generation Plant supplying the mine if the refinery is located on the same site (see utilities in Bauxite Mines)
- The substations, including transformers and battery rooms (ESS), should be adequately protected as per NFPA (See Rec section 11). Prefer dry-type electrics rather than oil-filled ones (i.e. breakers)
- IR scanning and DGA for transformers should be regularly implemented (at least once a year).
- Emergency diesel engine driven generators should be provided for the control of critical equipment and safety shut downs in case of a power outage.



Steam:

- Gas/fuel-fired steam boilers for digestion and calcination units

Prevention & Protection:

- Adequate safety combustion controls on dual gas/fuel steam boilers (both pilot and main gas lines) should be provided, as per recommendations in section 11.
- Backup (preferably 100%) should be provided for each related unit.

Cooling Water

- Cooling water is used for the process. The shell can be fire-resistive (reinforced concrete) or combustible (Fiber Reinforced Plastic /Poly Vinyl Chloride) with a light frame made of metal and/or plastic material. The hood is usually made of FRP and the packing of PVC. Note that all over the world, there are still quite a lot of cooling towers constructed out of wood.
- Cooling water is critical for the process.

Prevention & Protection:

- Prefer a 100% backup arrangement consisting of 2 well separated (at least 40 m) sets of cooling towers providing 100% backup.
- If all cooling towers are located in the same area (e.g. 1 set of 3 cells and 1 set of 4 cells separated by less than 40 m), ensure there is at least some spare capacity (eg. N+1 cells) and provide adequate automatic fire protection to both sets of cooling towers as recommended in section 11.
- Cooling towers should be situated at least 12 m away from areas of severe fire hazard.

2.6. Control Systems

Different arrangements are possible. The usual one consists of:

- A Central Control Room with a Main PLC Server Room used for both process operations and monitoring.
- Process control can be a SCADA (Supervisory Control and Data Acquisition) system which is connected to the Main Server Room.

Prevention & Protection:

- Depending on the arrangement, cyber security and a so-called “disaster recovery plan” for IT (i.e. loss of data) should be considered.
- Server room: when redundant servers are provided, they should be located in different areas. If only one server is provided, there should be a Contingency Plan and adequate automatic fire protection system (see Rec. for electric rooms section 11).
- Control Rooms should be protected with total flooding systems using a clean agent (i.e. including raised floors, false ceilings) that is safe for humans.

2.7. Spare Parts Warehouse

- Critical and very expensive spares are usually stored in one or more warehouses. Heavy spares and consumables are usually well separated. The inventory can represent several Million USD (e.g. \$20-40-60-80 Mio and more).
- These spares are critical to the process and can have a relatively long lead time. Some consumables used in relatively large quantities and/or having a long lead time are also deemed as critical. A major loss in such a warehouse could lead to BI for the related units due to lack of spares.



Prevention & Protection:

- Critical spares should be clearly identified. The commodity class should be clearly established as per NFPA and the warehouse should be provided with adequate and approved automatic fire detection / protection, as per section 11.
- Flammable and combustible liquids and spray cans should not be stored in such warehouses but should be stored in a dedicated safe area fitted with the necessary ventilation measures, leak detection & containment. Hazmat and compressed gases should be stored and protected in accordance with section 11.

2.8. Tailing

The alumina industry produces bauxite residue (red mud) as a by-product of the refining process.

Red mud is a thick red-brown paste consisting of silicon, iron oxide, titanium oxide and other compounds.

Red mud (tailing) can either be stored in a Tailing Dam (Mud Disposal Area) or as Dry Stack (Bauxite Residue Storage Area).

Tailing Dam (also called “Mud Disposal Areas” - MDA)

Red mud is disposed of in special isolated areas that can be called Mud Disposal Areas (MDA) or red mud storage facilities which are designed to prevent the seepage of alkali contained in the mud into the ground water.

At the level of the refinery, the mud settlers separate digestion blow-off slurry to produce a clear liquor with low suspended solids and thickened mud slurry. The slurry is washed in a counter-current decantation to recover the caustic soda from the settler underflow mud slurry while thickening the slurry into a paste suitable for disposal. High-capacity settlers and mud washers/thickeners are used for this. The mud washer circuit recovers caustic soda from the settler underflow mud slurry, while thickening the slurry into a paste suitable for disposal via counter-current decantation. Filtration of the mud produces a kind of "cake", in dry stacks.

The red mud is usually pumped from the refinery through pipes to a tailing dam located a few kms (2-3) away. The tailing dam usually consists of different cells or so-called “excavated red mud tailing pits (e.g. earth cells or pits divided by a causeway). These cells are each filled from several discharge outlets, spraying the red mud out in a layered format, usually to a maximum depth of around 1 m. The filtered cake is 60% solid with limited fluid and is disposed of in the mud lake. The cells are lined and samples should be taken regularly to monitor for leakage.

Mud Disposal Areas (or red mud storage facilities) are often referred to as “dry stack facilities”, even though the tailings are commonly discharged into the facility by pipeline deposition as described above.

The use of “dry stack facilities” in this case is a misnomer. In reality this is “conventional tailing storage” (high-rate thickened or paste but similar to a wet tailing dam), but the term 'dry stacking' refers to the final product based on the methods used to promote sedimentation and release of water within the facility and thus drying and gaining in strength. Due to the fine nature of the tailing properties, flocculation addition and mechanical disturbance are commonly used techniques, which increase overall operational costs.



Dry Stack (also known as “Bauxite Residue Storage Area” - BRSA)

Some low throughput alumina operations filter their tailings to produce a wet cake and thus 'dry stack' the tailings. This is the common definition of dry stack tailings or filtered tailings placement.

Bauxite residue produced in the alumina refinery process is press-filtered to a solid with low moisture content (i.e. thick mud or filtered cake is recovered from the underflow of each washer and transferred to the downstream mud washer for filtration to a dry filter cake using a series of filter presses).

The filtered cake, containing approximately 70% solids, is usually transported by truck to the Bauxite Residue Storage Area (BRSA). The residue (filtered cake) is dumped, dozed and compacted to conform to the residue configuration plan in the dry stacking methodology.

The BRSA may be operated by a third party providing Fleet Supply and Transportation Services, and Site Works and Services. The mobile fleet usually includes road prime mover trucks, ADT trucks (all terrain dump trucks), front end loaders, bulldozers, graders, compaction trucks and dust suppression trucks. Truck trailers carrying the residue may be customized for 20-45 tons and may have electronic tarpaulins, hydraulic/mechanical door seals, inclinometers, cameras, and a 50-degree incline bed offloading angle.

A typical BRSA land area is designed to cover several decades (up to 50 years) of bauxite residue storage which should accommodate future refinery developments (if any). A BRSA is therefore built in stages and each stage is dependent on the timing of the development of the refinery.

A typical BRSA includes the following elements:

- A network of haul roads and drains to facilitate transport of bauxite residue, collection of leachate and management of runoff
- A stockpile area for unloading and intermediate stockpiling of bauxite residue and waste delivered to the site by road trucks prior to placement in the cells. The residue and waste can then be reloaded onto ADT trucks for transport and placement into the cells where it is spread by bulldozers and compacted. The stockpile area should have a similar lining system as the cells described below.
- Cells for bauxite residue storage: storage cell floors should be designed to promote drainage of leachate to sumps. Cells may be 6.5 m deep or more, and are usually constructed with a lining system designed to resist the high pH conditions expected within the cells. This lining system may be comprised of (from the bottom up):



prepared subgrade

- geosynthetic clay liner
- 2 mm-thick HDPE geomembrane
- 500 mm-thick sand protection layer with a network of leachate collection pipes

The cells should also feature the following:

- a small perimeter embankment, a cell floor shaped to promote drainage of leachate to sumps (at least 2 per cell to ensure redundancy)
 - two-way access ramps (1 or more per cell depending on the size) over the perimeter embankment to enable vehicles hauling waste to access the cells
 - stormwater management drains to channel stormwater to the runoff pond
 - benches on the outer slope to enable progressive capping and rehabilitation of waste slopes
- A pond with one or more compartments for storage of run-off and leachate. The leachate and runoff pond should have similar lining systems to the cells above.
 - A system to monitor leachate levels in the sumps alerting operators when leachate needs to be extracted from the sumps.
 - A network of ponds for management of liquids proposed for use as dust suppressants (i.e. Neutralized Waste Slurry -NWS- sedimentation ponds and/or Dust Suppression Water Ponds). The usual arrangement is as follows: The Dust Suppression Pond is used for storage of (sea)water trucked to the site for dust suppression of the bauxite storage cells. The water is extracted from the pond by ADT water trucks. Neutralized water slurry is brought from the refinery to the BRSA by tankers and discharged into the sedimentation ponds. Solids in the NWS are retained in the ponds and the liquid is decanted into the Clarified Liquid Pond.

In addition to bauxite residue the waste is expected to include oxalate, lime grits, red side scale and the solid components of neutralized slurry (usually these wastes will comprise only 2-5% of storage volume).

The residue is usually stored as layers in the cells (e.g. initial layer 500 mm thick and subsequent layers 300 mm.) The cells are operationally divided into 'bays' to allow time for the residue to dry to the required moisture content before compaction.

Prevention & Protection:

Please refer to Handbook "Tailing and Tailing Management Facility"

3. CONTINGENCY / BUSINESS CONTINUITY / RECOVERY PLAN

Warning: in order to be reliable, Contingency / Business Continuity / Recovery Plans should be formalized. This would include formal contracts established in advance with vendors or third parties. The plans should be regularly tested, reviewed and updated.

Holistic view:

- If the Refinery is part of a group with a relatively high level of vertical integration in the aluminum industry, a Business Continuity Plan (BCP) at corporate level should be developed for the main identified risks in each and every process unit.
- The impact of a loss impacting thirds parties (i.e. logistics, utilities) should be investigated and an adequate BCP should be established.

Site view:

- Electrical power: dual feeders (100% back up) connected to different substations of the grid or a captive power plant is always the best .
- General inbuilt process equipment redundancies (basically N+1 considered at the design stage) would help in mitigating the risks of Business Interruption.



4. LOSS HISTORY

4.1. High Pressure Rupture of the Digester

In 1999, there was an explosion at an aluminum refinery that injured 29 people.

Investigators from the Mine Safety and Health Administration (MSHA) found that an electrical power failure that occurred about 30 minutes prior to the explosion caused the refinery's electrically-powered process machinery to stop.

Electrically powered pumps, therefore, could no longer move the extremely hot liquid called "slurry" through the tanks in the process.

The tanks then exploded with great force, resulting in the near total destruction of four tanks and the release of hot caustic material across the plant and into the surrounding community.

Investigators found that the plant's system of relieving pressure in the tanks failed to prevent the build-up of pressure because relief valves had been impermissibly blocked.



Image taken from the Department of Labor Mine Safety and Health Administration [Web site](#)

Among the many findings, the MSHA concluded that:

- The Refinery failed to follow the industry standard requiring functional pressure relief safety systems to be maintained for the digestion area pressure valve.
- Refinery management failed to conduct required workplace examinations to identify conditions and practices that posed hazards to employees and did not promptly correct the hazardous conditions and unsafe practices that were evident.
- The Refinery did not provide adequate safety and health training for employees nor did it provide proper training on safe operating procedures for their assigned tasks.
- The Refinery failed to provide adequate protective clothing for employees who were exposed to hazardous chemicals.



4.2. Flood events impacting tailing

2017 - Latin America. A flood event happened subsequent to a very severe heavy rain episode that led to floods in some areas of the refinery and the neighborhood. Rain water carrying some red mud from the tailing broke out of the refinery boundaries and flowed into the nearest city sewer network.

Local authorities considered potential contamination and imposed a 50% production capacity restriction.

The refinery management took preventive measures consisting of upgrading its rainwater drainage system.

5. LOSS ESTIMATES

Maximum Possible Loss (Technical MPL – SCOR):

- For High-Pressure Vessels:
 - The worst case would be a high-pressure rupture and explosion of one of the digester vessels located centrally. The other digester vessels might be flanked on either side by the flash tanks.
 - The explosion would likely destroy the digesters and the majority of the surrounding plant including piping and cable trays, evaporators, the spent liquor plant, mud washers and condensate storage, plus there could be peripheral damage to areas further away.

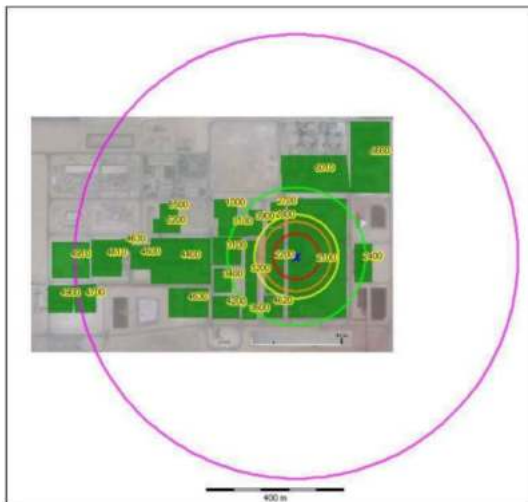

Courtesy of Virtual i Technologies Ltd, Risk Engineering Service Provider for Aon in the Middle East

Different simulation tools – ALERT (AON), SMART BLAT (AIG), FAST (Willis), EXTOOL (Swiss-Re, SCOR) for high-pressure vessel rupture and explosion can be used to show the impact to the immediate and surrounding areas further away (as shown below for a 65 bar-working pressure digester).

Note that high pressure is usually defined as exceeding 1 bar / 15 psi. Pressure vessels typically fail at multiples of the design pressure (“MAWP”: Maximum Allowable Working Pressure). In most cases, the pressure at which the vessel will effectively burst cannot be precisely predicted. Literature indicates that medium to low pressure vessels would fail at 2 to 4 times the MAWP (i.e. up to 10 bars at 4 times the MAWP, and never less than 10 bars since a vessel operating at 1-2 bars is at least designed for a pressure of ten bars). For high-pressure vessels, it would be more in the range of 1.5 times the MAWP.

(*) “Secondary fire” and “firefighting, debris removal” may respectively represent 10% and 5% of additional Property Damages.



The following information is usually required for the simulation:

- Total vessel volume.
- Normal liquid and gas free volume in the vessel (assuming normal conditions. However, a runaway reaction or overheating condition will lead to more liquid being vaporized, thus, increasing the volume of gas).
- Normal operating pressure of vessel.
- “MAWP”: Maximum Allowable Working Pressure of vessel.
- Bursting pressure of vessel (when available).
- For “low”-pressure vessels (basically overpressure radius damages not resulting in significant damages nor Business Interruption), see the following scenarios:
 - The combustible load and the continuity of combustibles (mostly spot fire areas) is usually relatively low within the process areas.
 - The MPL scenario is a fire destroying the main substation. There would be up to 6 months BI for reinstatement (min 4). In the meantime, the refinery would be shut down.
 - The rupture of a tailing dam exposing critical facilities of the refinery and/or third-party facilities and/or releasing material outside the refinery property limits (e.g. sewer network, river, estuary, etc.) may lead to property damage and/or the administrative closure of the refinery (i.e. for the investigation period, the principal of precaution would be applied for environmental considerations, etc.). This could be the MPL scenario.
 - A catastrophic failure at a tailing dam followed by an administrative closure.
- Induced BI in case of interdependencies with sister plants upstream and/or downstream should be considered. This could be mitigated by buffer storage (providing several extra days of production) and an alternate supplier (if any).

Probable Maximum Loss (Market definition):

Note that in terms of loss estimates at SCOR only MPL and NLE are considered. There is no leeway for using any other acronym or definition (i.e. EML, PML, etc.). EML or PML are only given for information.

For PML / EML purpose, the High Pressure Rupture of a vessel may be considered by some actors of the market as a so called "remote scenario" with very low probability. As a result this scenario may be totally ignored even if it occurred already. The PML / EML scenario will be therefore focussed on a so called "more credible" event such as a loss in an electric substation.

Normal Loss Expectancy (NLE – SCOR):

- Same scenario as for the MPL of “low” pressure vessels (fire destroying the main substation or rupture of a tailing dam).
- Induced BI in the case of interdependencies with sister plants upstream and/or downstream should be considered. This could be mitigated by buffer storage (providing several extra days of production) and an alternate supplier (if any).



V - ALUMINUM SMELTER FOCUS

1. PROCESS

A Smelter Process Flow at a Glance:

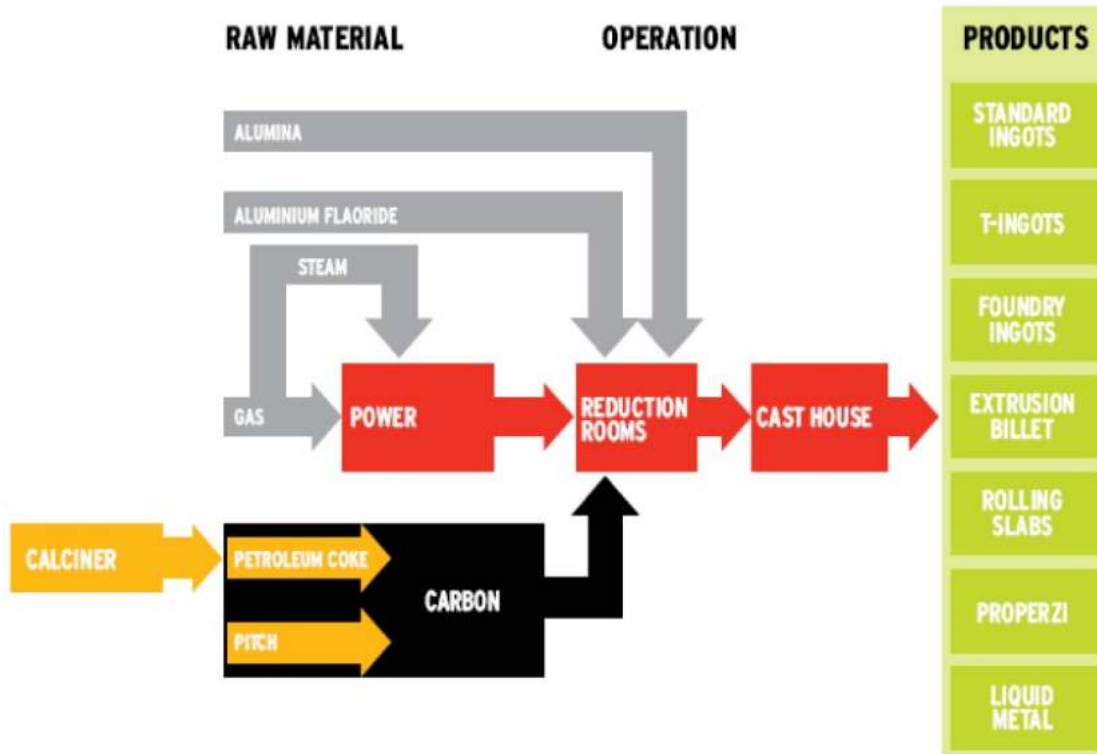

Courtesy of Virtual i Technologies Ltd, Risk Engineering Service Provider for Aon in the Middle East.

The Reduction Principle:

- The industrial reduction of alumina into aluminum metal is carried out in the smelter, using the Hall-Heroult electrolytic process.
- The objective of the process is to break down alumina (Al_2O_3) into its two components, aluminum and oxygen.
- The Hall-Heroult process is based on the use, as a solvent of alumina, of sodium hexafluoro aluminate (Na_3AlF_6) or cryolite. Molten cryolite is an effective solvent of alumina, has an acceptable melting temperature (around 1012°C (1854°F) for pure cryolite), and good electrical conductivity in its molten state. In addition, the density of the alumina molten cryolite electrolyte is lower than that of molten aluminum.
- The molten aluminum metal at the bottom of the cell acts as the cathode in the electrolysis cell. Carbon exhibits good electrical conductivity and good resistance to corrosion from the electrolyte at high temperatures and is therefore suitable for the anode.
- Alumina is also regularly added to the electrolyte, or bath.
- The molten aluminum depositing at the cathode at the bottom of the cell is regularly siphoned off (tapped out) and sent to the caster.
- While cryolite was the basic solvent in the original process patented by Hall and Heroult, electrolytes are now composed of alumina (the solute) and a mixture of cryolite (the main solvent) and various additives.

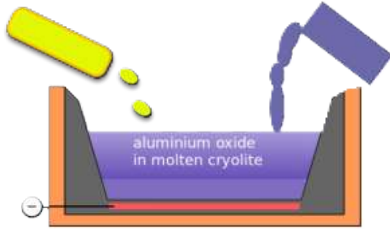
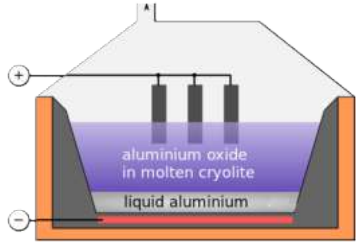
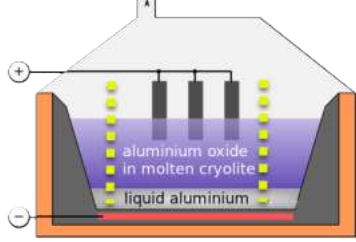
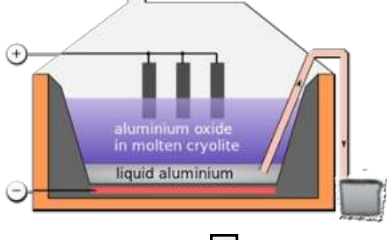
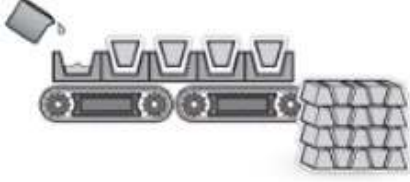

Reduction Plant process overview:

	<p>Step 1: addition of bath and Alumina</p> <p>Inside a pot or cell, alumina is dissolved in a “bath” of molten cryolite (sodium aluminum fluoride) and other materials.</p> <p>A pot or cell is a large rectangular cell, lined with carbon blocks and insulating bricks. This lining forms the “cathode”.</p> <p>A pot line is a long building, or collection of buildings, which contain a series of “pots”, or large electrolytic cells, in which aluminum is made.</p>
	<p>Step 2: Anodes</p> <p>Anodes are used to conduct electricity into the smelting cells/pots in the pot room. Anodes are consumed in the smelting process and the remaining portions (known as butts) are recycled.</p> <p>Anodes are attached to rods and suspended into the electrolytic cells in the pot room where they are slowly consumed in the aluminum smelting process.</p> <p>Carbon anodes, made from petroleum coke and pitch, are often manufactured on site at the Carbon Plant.</p>
	<p>Step 3: Electrolysis</p> <p>A high electric current is passed through pots via the anode. The current flows continuously from the anode (positive) through the alumina/cryolite mix to the lining of the pot (negative) and then onto the next pot. Electricity maintains the temperature of the process at about 950°C and enables the alumina to split into aluminum and oxygen.</p>
	<p>Step 4: Tapping</p> <p>At regular intervals the molten aluminum is tapped from the pots and transported to the Cast House or to Downstream Aluminum plants by Metal Transport and Tilting Vehicles – (MPTTV).</p>
	<p>Step 5 – Primary Casting:</p> <p>At the Cast House all admixtures (iron, silicon, copper, etc.) are removed by re-melting the aluminum in a special furnace at 800-900°C. Scraps can also be re-melted.</p> <p>Then, molten aluminum is cast at a temperature of just over 700°C to form ingots, slabs, billets and T-bars.</p>

- While many complex chemical reactions are occurring within the industrial cell, the main electrochemical reaction occurring at around 960°C (1760°F) can be represented by the equation:



Client Guidance Note - Risk Control Practice

- $2 \text{ Al}_2\text{O}_3$ (solution) + 3 C (solid) (6) \rightarrow 4 Al (liquid) + 3 CO_2 (gas)
- However, some of the metal deposited at the cathode is dissolved in the electrolyte, transported and re-oxidized at the anode according to the reaction:
- Al (solution) + 3 CO_2 (gas) (7) \rightarrow Al_2O_3 (solution) + 3 CO (gas)
- From these equations, one can see that the carbon anode is consumed in the process and must be replaced on a regular basis.
- According to Faraday's law, an electrical current of 1 Ampere should deposit 0.336 g (0.01176 ounces) of aluminum per hour.
- The actual industrial cell production rate is lower, ranging from 85% to 95% of the theoretical value. There are various theories to explain this. The metal re-oxidation (at anode level # known as reverse reaction related to anode quality), per the equation above, is certainly one of the actual occurring parasitic reactions affecting the cell productivity.

Anodes in the smelter operation:

- The anodes are consumed as time goes by and need to be replaced on a regular basis (30 to 40 days on average - from 4 to 40 anodes per pot depending on design).
- Anode change operations are one of the most critical tasks to be performed in a smelter, requiring an entire separated plant upstream for manufacturing new anodes (usually called the "Carbon Plant") and recycling the spent ones (the so-called "Back Plant").
- Since anodes are made of carbon, they easily react with oxygen in the air, leading to extra consumption of carbon material, exposure of stubs and/or cast iron, increased levels of Fe in the metal, lower current efficiency, burn-offs, etc.
- To avoid these problems, anodes need to be properly covered on the top surface and sides with a mixture of crushed bath and alumina, which requires a dedicated bath handling/crushing/mixing facility in the smelter.

Carbon Plant:

- Two ingredients are used to manufacture an industrial carbon anode: a "filler" material and a "binding" material.
- The "filler" is generally petroleum coke, but coal-tar pitch coke is also used.
- The "binding" material is usually coal-tar pitch, but selected grades of petroleum pitch are also used.
- Spent anodes are reclaimed from the pots. After separation of the metal stem or rod from the anode butt, the butts are crushed and recycled as carbon filler material.

Cast House:

- Molten metal is received at the Cast House from:
 - the Reduction Plant
 - the Can Reclamation Unit (if any)
 - the re-melted scrap metal from the Rolling Mill (if any)
- Metal is transported to the Cast House in ladles (e.g. 13.3 mt capacity) by specialized Metal Transport Vehicles (MTV) or Metal Transport & Tilting Vehicles (MTTV).
- At this stage the metal still contains a lot of iron, silicon, copper and other elements. Admixtures such as iron, silicon, copper, etc. are removed by re-melting the aluminum in a special furnace at 800-900°C.
- Then, molten aluminum is cast at a temperature of just over 700°C to form ingots, slabs, billets and T-bars.
- Metal Pouring Transport Vehicles (MPTV) are utilized within the Cast House for transport and pouring of molten metal into molds.
- The casting line for the ingots, sows, T-bars and billets plant may be a continuous homogenizing furnace and a VDC (Vertical Direct Cooling) casting machine. The casting line can be either water-cooled or air-cooled.



- The largest ingots, 30-tonne slabs 11.5 m in length, are made in special molds buried up to 13 m in the ground. Hot aluminum is poured into a mold like this over a period of two hours, with the slab 'growing' in the mold like an icicle, only from the bottom up. As the slab is cast, it is cooled down with water and as soon as the casting process is complete, the slab is ready for shipment.



Courtesy of Aluminium Bahrain B.S.C. (Alba) – Aerial view of a smelter

2. SPECIAL HAZARDS & RISK CONTROL

Special hazards, prevention, protection and potential mitigation measures are detailed below for each and every special hazard related to this occupancy (following the process flow from the raw material to the finished product as much as possible). Related recommendations are also mentioned, (see. Rec). Please refer to section 11. “Support for Loss Prevention Recommendations” for details.

2.1. Carbon Plant

A typical Carbon Plant is made up of the following sub units:

- A Paste Plant (green anode production):
 - Coke crusher, preheater (x 1), mixing drums (so called Irish drums x 2), vibro-compactors (x 2)
 - Use of sprayed emulsion (90% water / 10% oil) on coke.



Anode mold – outer part
("box" open top & bottom)



Moving part
(press)

Courtesy of Aluminium Bahrain B.S.C. (Alba)

- An HTF/M (Heat Thermal Fluid/Media) boiler(s) and loop (e.g. Therminol 66, Fp°170-184, which can be operated over a flash point of around 200°C - max 250°C).
- An Anode Baking furnace (ABF or BF): CNG gas-fired or other fuel. An ABF is basically an aboveground rectangular structure made of reinforced concrete walls covered with a roof (open sides). Different layers (e.g. 3) of refractories or "insulated fire bricks" are installed along walls and at the bottom and walls of refractories are built inside dividing the ABF in cells and sections (i.e. 3 cells, 52 sections, 189 anodes per section equivalent to the anodes for 9 pots 1,200°C 14-15 days).



- A rodding plant: hydraulic presses (e.g. x 2), induction furnaces (e.g. x 2)
- A back end (anode recycling plant including strippers).



Raw Materials include:

- Liquid pitch used in its liquid state at temperatures between 160 and 190°C (320 and 375°F). Solid pitch is not normally used any more (due to environmental regulations and high safety hazards).
- Pet coke or coal tar pitch. When calcinated at a temperature around 1300°C (2370°F) prior to use, petroleum coke can be considered as practically inert, virtually non-combustible, and definitely non-explosive. More than 25% of the pet coke can be obtained from recycled used anodes and 5% from rejected green anodes.

Finished products are rodded baked anodes that are then used in the cells of the Reduction Plant.



Rodded anode
Courtesy of Aluminium Bahrain B.S.C. (Alba)

Fire and mechanical breakdown hazards tend to be more significant in a carbon plant. Fuel-loading in a carbon plant can include Heat Transfer Fluid/Media (HTF/HTM), process materials (petroleum coke and pitch) and hydraulic fluid, which, when combined, can support a large fire. The structure is usually constructed of unprotected steel and due to the high heat generated by the fire load in the plant, the structure is expected to lose integrity and collapse.

Abnormal operating of anode baking furnaces can lead to combustible or flammable residues (depending on fuel type) forming in the downstream exhaust ductwork and emission-control equipment.

The Fume Treatment Plant (FTC, including the bag house) is important since the Carbon Plant usually cannot operate without the FTC (as per environmental regulations).

From a mechanical breakdown perspective, replacement parts for specialized process equipment, such as the preheater and kneader, often have long lead times.



A fire in the Carbon Plant or critical equipment failure has the potential to disrupt carbon plant production for up to several months.



*Carbon Plant – Sprinkler protected paste plant
Courtesy of SOHAR Aluminium LLC*

Prevention & Protection:

- Liquid pitch tank(s) should be located in a secondary retention area able to contain 100% of the tank(s) plus 20% for fire water. Monitors should be provided around the tank(s). If there is mutual exposure of tanks, adequate cooling rings should be provided. The provision of a nitrogen blanket on the pitch tank is optional.
- The use of calcinated pet coke should be preferred (as it is practically inert, virtually non-combustible and definitely non-explosive).
- All critical conveyors (including bucket conveyors) should be adequately protected as recommended in section 11.
- All areas of the paste plant (multiple-level buildings – usually open-sided) should be fully sprinkler-protected as recommended in section 11. This is usually the most demanding area in terms of fire water demand within a carbon plant. The fire water supply should be designed according to recommended sprinkler discharge density following NFPA 13 and including hose streams as appropriate.
- The sprinkler heads within the Paste Plant (e.g. around the Compensation Liquid Pitch Tank, compactor, etc.) need to be cleaned regularly, as a matter of good practice, to prevent the build-up of oily residue. This prevents the sprinkler heads being caked in an oily residue which has the potential to affect their proper operation. If required, safeguards such as thin paper bags should be placed over the heads to protect them against an oily residue build-up.
- The HTF/M boilers and loops should be adequately protected and provided with all safety interlocks including, but not limited to, ATEX (when HTF/M is operated above its flash point) and emergency drain tanks and retention.
- Non-Wicking cladding for Paste Plant is recommended for either pitch or HTM piping: for instance cladding - silicon based jacket - that will not wick (soak up) HTM spills/leaks like traditional rock wool lagging. HTM soaked lagging presents a fuel source for fire.



- Hydraulic groups should be protected, as recommended in section 11 - either sprinkler-protected or using FM-approved less combustible fluids (e.g. Quintolubric 888-46 for hydraulic groups at the paste plant or rodding shop hydraulic groups for the press).
- All critical electrical rooms (e.g. Carbon Plant, FTC) should be protected, as recommended in section 11.
- Adequate maintenance program (also called “maintenance strategy”) for the ABF should be established depending on technology and arrangement:
 - e.g. for a smelter with a single ABF, 5 years cycle. No complete shutdown. Continuous maintenance strategy: 8hrs shut down every week (keep heating). 11 floors replaced every months, prefab walls prepared on site.
 - e.g. when multiple ABF (e.g. 5 years program), life span of up to 230 cycles # 11 years depending on technology. Total shutdown of one ABF per year and rebuilt: e.g. for a smelter in the gulf: USD 31M total project of which USD 20M for the bricks made of 46% of alumina and specific density (20,000 tons of bricks shipped from Europe in 150 containers). About 90 days duration involving a specialized contractor on site.
 - All material are moved using overhead cranes.
- Overhead cranes (e.g. ABF) should be adequately parked and detected / protected when needed, as recommended in section 11.



2.2. Reduction Plant

Potline building:

- Any source of water (rain, snow) introduced into the potline may result in “superheated steam explosion” when in contact with molten material.

Prevention & Protection:

- A regular building roof inspection program should be established and strictly enforced. Any roofing, drainage deficiencies should be fixed asap and adequate and reliable water proofing actions should be considered at all times.

Pot Quality:

Pot quality problems may cause a tap out (leakage) or short/open circuit leading to an unbalanced pot line and a potential trip. According to some smelter managers, pot quality issues reportedly result from “routine” based operations (“routine” being perceived as “killing” the risk awareness). In the case of multiple problems involving multiple pots at the same time, the staff would be overwhelmed. This could lead to a very critical situation i.e. trip and pot freeze.



Courtesy of Aluminium Bahrain B.S.C. (Alba) - Potline

Prevention & Protection:

In order to prevent and limit the number of issues the staff would need to deal with all at the same time, (in an attempt to avoid a multiple leakage situation), the following measures are currently established in some smelters:

- **“Pot Control Teams & Measurements”**: one team is responsible for a certain number of pots and in charge of monitoring key parameters on a daily basis (e.g. high or low bath levels e.g. 18cm standard level for some smelters, anode effects, abnormal conditions, sampling for iron-content measurements resulting from a pot shell erosion that could lead to a tap out, tools fallen in the bath, erosion of rod seal of the anode in case of high



level of the bath etc. note that depending on origin the alumina can contain metal of which iron). This team reports directly to the Operations Manager.

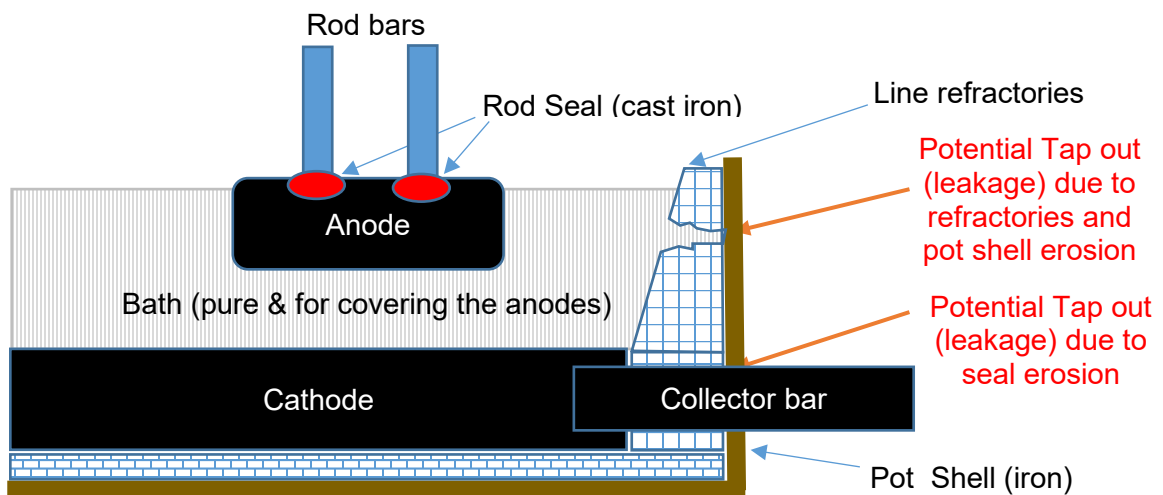

Pot Cross section view – not to scale

- “*Systematic Operation Audit Protocols*” as part of the Safe Operation Procedure, consisting of a set of compliance check lists for each and every task, aiming at detecting and reporting any deviation from standard operations (Schedule: 3 every day for the Supervisor and 2 every week for the Operations Manager). The reports are reviewed every week.
- “*Bonus Incentives*” for motivating teams to enforce the Operation Audit Protocol and to measure compliance against results (e.g. KPI: pot line stability).
- A “*Superintendent Level Process Safety Engineer*” on board. A high level of expertise is required as he/she monitors production and processes any abnormal situation, identifying the root causes.
- A *Decision Maker on a shift basis* ensuring leadership in case of an emergency.
- A *Technical Manager on board*, in charge of checking the integrity of production at the global level (Carbon Plant – Reduction Plant – Cast House).
- A *CMMs Maintenance program*: all critical equipment registered. All due lists and back logs directly reported to the CEO.
- *Pot line condition programs*: Go/No-go conditions checked every day (using key parameters: e.g. T°, bath levels and change-over of Risk Manager)
- *Ensuring proper (routine) operations for bypassing a cell* using wedges: during normal operations in order to isolate one cell (e.g. to rebuild it, or in the case of a tap out / leakage or short/open circuit, in order to prevent an unbalanced pot line and potential trip) while maintaining the continuity of the electrical series, jumpers or sections of bus bars that are kept and used to electrically bypass a cell or group of cells. Short-circuiting “wedges” are usually inserted between two conductors to take an electrolysis cell offline.
- A *Contingency Plan and Emergency Preparedness* (see section Contingency / Business Continuity / Recovery Plan)

Loading / Unloading Facilities:

- Alumina pot room hoppers: (e.g. 2 t capacity and more): used for the transfer of raw materials (alumina and additives) to the electrolytic cells via a pot room crane.



Hoppers

Courtesy of Aluminium Bahrain B.S.C. (Alba)

- Pot Tending Assembly (PTA): multipurpose overhead cranes are used to service the cells. These cranes replenish the cell alumina hoppers, change the anodes and tap the metal.
- Pot tapping: every day, during normal operations, ladles are used to tap liquid aluminum from the pots (e.g. 3 t per pot). A ladle is used to tap the pots (e.g. a ladle having a capacity of 12 t, is used to tap 3 pots maximum).



Bath Tapping

Courtesy of Aluminium Bahrain B.S.C. (Alba)

- More than 200 mobile equipment machines can be used on site including:
 - Anode Pallet Transport Vehicles (APTV): carrying the Pot Tending Assembly (PTA) (e.g. one pallet contains 6 rodded anodes. An APTV can carry one pallet at a time).
 - Metal Transport & Tilting Vehicles (MTTV): carrying crucibles (e.g. 12.5 t capacity and more) between the Smelter and Cast House and also delivering to downstream customers.
 - Aluminum crucibles / Bath Tapping Crucibles (BTC refractory-lined cast iron vessels (e.g. 12.5 t capacity and more) used to carry hot metal to the Cast House and Aluminum Downstream customers.



APTV



MTTV

Courtesy of Aluminium Bahrain B.S.C. (Alba)

- The maintenance of the above mobile equipment is usually done in a dedicated workshop including:
 - A mechanical crucible cleaning machine
 - A mechanical tube cleaning machine
- Electric dryers & heaters to control the moisture and temperature of equipment used at the Reduction Plant that could allow water to be introduced and trapped in molten metal leading to a “steam explosion”. A “steam explosion” is, in fact, a “deflagration” (considering that such energy is likely to be less than the speed of sound, thus subsonic speed) caused by violent boiling or flashing of water into steam which occurs when water is rapidly heated by the interaction of molten metals. This applies to the following equipment:
 - Bath Tapping Crucibles (BTC)
 - Alumina pot room hoppers

Prevention & Protection:

- Redundancy of equipment is key (e.g. PTA within the potline, APTV, MTTV, BTC). In some smelters there is a dedicated PTA (standby) for the BCM carrying the bridge and tool kit. See “Pot to Pot Emergency Bridge” section 5.3.
- Moisture and temperature control is key for BTC, alumina pot room hoppers and crucibles. The availability and systematic use of electric dryers & heaters is important.

Housekeeping:

- Alumina tends to accumulate under the pot cells (from spillage during the pouring operation). This acts as an insulation blanket under the cell preventing heat produced at the cell from dissipating.

Prevention & Protection:

- Regular cleaning should be carried out using a special remotely operated vacuum cleaner passing under the pots between the concrete structural members (for reasons of human safety).

Pot delining / Spent Pot Lining (SPL) / Pot relining:

- The design life operation of a pot depends on the technology and the operating amperage. For instance, an average of 2000 - 2,200 days is reported at 395 kA-390 kA. The pot life span tends to decrease at higher amps (e.g. 1,850 days at 400 Amps instead of 2,000 at 395 kA). When a pot is at the end of its design life operation, it should be delined and re-lined This involves the following facilities:
 - A Delining Stand: using a mobile hydraulic hammer to remove solidified aluminum slab, cathodes and refractory assembly from the carbon steel pot shell. The stand is usually provided with a de-dusting system. There is usually one stand per smelter (#1 pot line). The maximum design capacity can be very different from one smelter to



another (e.g. 15-21 pots per month). The pot delining stand may be attached to the smelter's building or located in a detached building.



Pots taken out from potline for delining



Delined pot

Courtesy of SOHAR Aluminium LLC

- A Spent Pot Lining (SPL) material treatment facility: handling 1st cut (cathodes), 2nd cut (refractory) produced at the pot delining stand, breaking, grinding (up to 12-15 mm particles) for disposal or to be used at the:
 - 1st cut: steel mills
 - 2nd cut: cement plants.

The usual process consists of SPL being broken up and separated (using a transportable excavator) into aluminum metal (by-product), cathode bars (by-product) and SPL lumps. The smaller lumps may then be fed into a so-called Primary Crusher (PC) where SPL is broken down into 300 mm lumps and sieved, with the oversized lumps and retained aluminum returned to the excavator section for reprocessing. More cathode bars are separated from the SPL.

The smaller SPL lumps are then usually fed into a Crushing and Metal Recycling Plant (CMRP). The lumps are reduced to 12-15 mm and both the iron and aluminum elements are removed, as separate by-products, through a ferrous metal separator. Both the PC and CMRP are usually equipped with dust collection systems, with a recycle element back to the CMRP facility. This includes a single / multiple bag collection system with a variable drive ID fan arrangement, venting through a stack. The dust is collected and feeds screw mixers that send larger material back to the CMRP and the fine material to a dust skip.

The smaller 12-15mm lumps are usually fed across to the Thermal Treatment Plant (TTP) where there is a two-stage process. The material is heated up and passes through a four-variable drive thermal treatment reactor, where the heat-treated material is hydrolysed. The kiln (e.g. 30 tonnes, 1.8 m diameter, 9 m long gas-fired rotary kiln) is fitted with a separate dust collection system, driven by a variable drive speed ID fan and venting to the atmosphere. The dust collected is screw-mixed and feeds the TTP reactor. There is usually a vent to the reactor passing through the rotary kiln. It is likely that hydrocarbon, cyanide, hydrogen fluoride and hydrogen sulfide may be liberated at the TTP section of the process.



The SLP facility may be attached to the smelter's building or located in a detached building.

- Pot relining bays: pot shell refurbishment (e.g., trimming, welding), assembling refractory brick with mortar and installing cathodes. There are usually 4 to 6 relining bays per smelter (#1 pot line). The maximum design capacity can be very different from one smelter to another (e.g. 15 pots per month max.). The pot lining bay may be attached to the smelter's building or located in a detached building.



Cathodes



Lined pot

Courtesy of SOHAR Aluminium LLC

Prevention & Protection:

- De-dusting facilities for the delining stand may be mandatory (as per environmental regulations). This limits the capacity of delining pots outside the stand when needed (i.e. a pot freeze situation). As a result, critical spares for the de-dusting unit should be available and potential clearance from authorities should be granted when delining strategies outside the stand are included in the Business Continuity Plan (i.e. a pot freeze recovery strategy. See section Contingency / Business Continuity / Recovery Plan).
- Spent Pot Lining Thermal Treatment Plants (SPL-TTP) should be provided with the following in-built safety and fire/gas detection and fire protection:
 - Adequate safety combustion control for the rotary kiln as per section 11. A secondary/emergency drive system for the rotation of the rotary kiln should be provided unless it is sure that the kiln will not distort if rotation ceases (so-called 'banana effect').
 - SIL (Safety Integrity Level) study and LOPA (Layer of Protection Analysis) should be performed on the kiln and reactor processes.
 - For the Hydrolysis Reactor (TTP reactor) exothermal emergency venting should be provided (venting in a safe area).
 - Key spares should be identified and provided as part of the project/contract, such as variable drive motors, fans, gear boxes, girth gear etc.
 - Intrinsically safe electrics in areas where flammable / explosive gas may be released and/or accumulate (ATEX assessment and electrical zoning required).
 - Hydrocarbon and hydrogen sulfide detectors should be provided within the TTP section of the process.
 - Any hydraulic oil / lubricating oil systems should be protected as per section 11.
 - Instrumentation, controls and interlocks should be fitted on the reactor and rotary kiln.



- Make sure there are NO combustible elements (plastic or foam) within the metal walls or roof construction elements. The SPL may be water-reactive, necessitating an imperviable membrane be provided along the walls at an adequate height (at least 0.5 m).
 - Dust collection bags should be of the non-combustible type, or adequate and reliable fire protection (e.g. sprinklers or inert gas extinguishing, or a combination of both) should be provided. In the case where there is no fixed fire protection it should be ensured that hot embers/sparks can be prevented from jumping from the rotary kiln to the dust collector.
 - Manual firefighting should be provided.
 - Critical electrical rooms should be protected, as per section 11.
 - Rubber belt conveyors including bucket conveyors (if any) should be protected, as per section 11.
- The inventory of refractory and mortar available on site for relining purposes should, at least, correspond to the number of pots planned to be relined per year (e.g. 100 pots relined per year). This is in order to prevent any disruption of production that could result from supply chain issues.

2.3. Cast House

- Hot metal from the reduction plant is processed at the Cast House. Re-melted scraps can also be used. External scrap may introduce contaminants that could jeopardize the finished product quality but also introduce a major hazard inside the Cast House such as high moisture content, liquid in the containers (e.g. cans) or even radioactive material. Some Cast Houses only accept internal scrap (from the Cast House itself or from the Rolling Mill downstream, when integrated). Note that some Cast Houses also limit the use of internal scrap to a certain percentage (e.g. 60%) because of steel and other contaminant content. The remaining scraps are sold to third parties.
- Steam explosions in furnaces are caused by violent boiling or flashing of water into steam, occurring when water is rapidly heated by the interaction of molten metals. This can happen in a furnace.
- Explosions may be caused by a fuel/gas leak or an accumulation inside a fuel/gas-fired furnace during the startup of operations.
- Different methods are used for mold lubrication or coating (e.g. nanotech technology consisting of a fine powder of mineral material or an emulsion involving mineral oil in water or a graphite-based coating). Coatings are usually applied following a regular schedule (e.g. every 2 weeks).
- Some molds are air-cooled and others are water-cooled requiring a large amount of water (e.g. 1,000 cum/hr) circulating in a closed loop, including cooling towers.





Prevention & Protection:

- Strict control procedures for both internal and external scraps should be established and enforced, including but not limited to, the detection and monitoring of liquid and/or moisture content, detection of radioactive material, etc. In some countries, this is done by requiring a test report on the external scraps prior to receiving them. Additional tests on site are also recommended in some cases, as external certificates cannot be fully trusted.
- Strict moisture content of scrap should also be enforced. Solid scrap should not be introduced into molten liquid but rather re-melted exclusively from a solid state to a liquid one. Crucibles used to carry hot metal should be prepared (drying and heating: See loading / unloading facilities above) prior to being used at the reduction plant.
- Adequate safety combustion controls should be provided on fuel gas lines, as recommended in section 11.
- Non-combustible mold lubricants and coatings should be preferred.
- The process cooling system for the Casting Plant is critical in order to maintain casting operations. It is usually a single circuit with electrical pumps. The pumps should preferably be designed with N+1 redundancy. Backup power supply for these pumps is also recommended (i.e. process cooling system pumps connected into a backup diesel-fueled power source). Some “casting centers” (when multiple cast houses) have their dedicated “cooling water plant”.
- The critical cooling water tower (part of the cooling system above) should be protected, as recommended in section 11.
- Overhead cranes should be adequately parked and detected / protected when needed, as recommended in section 11.
- Note that in some cast house the machines are mostly interchangeable. Thus minimizing interruption of operation in case of equipment failure. Potential bottleneck should be identified (as part of the Contingency Planning).



2.4. Utilities

Electric Power

- Power to the smelter main substation is supplied at a high voltage (e.g. 380kV) from the grid and/or Captive Power Plant through overhead lines across transmission towers. At the smelter substation, there are breakers, SF6 gas-insulated busbar systems (Gas Insulated System – GIS SF6) and control bay cabinets. A typical arrangement is shown below: (© Didier Schütz)

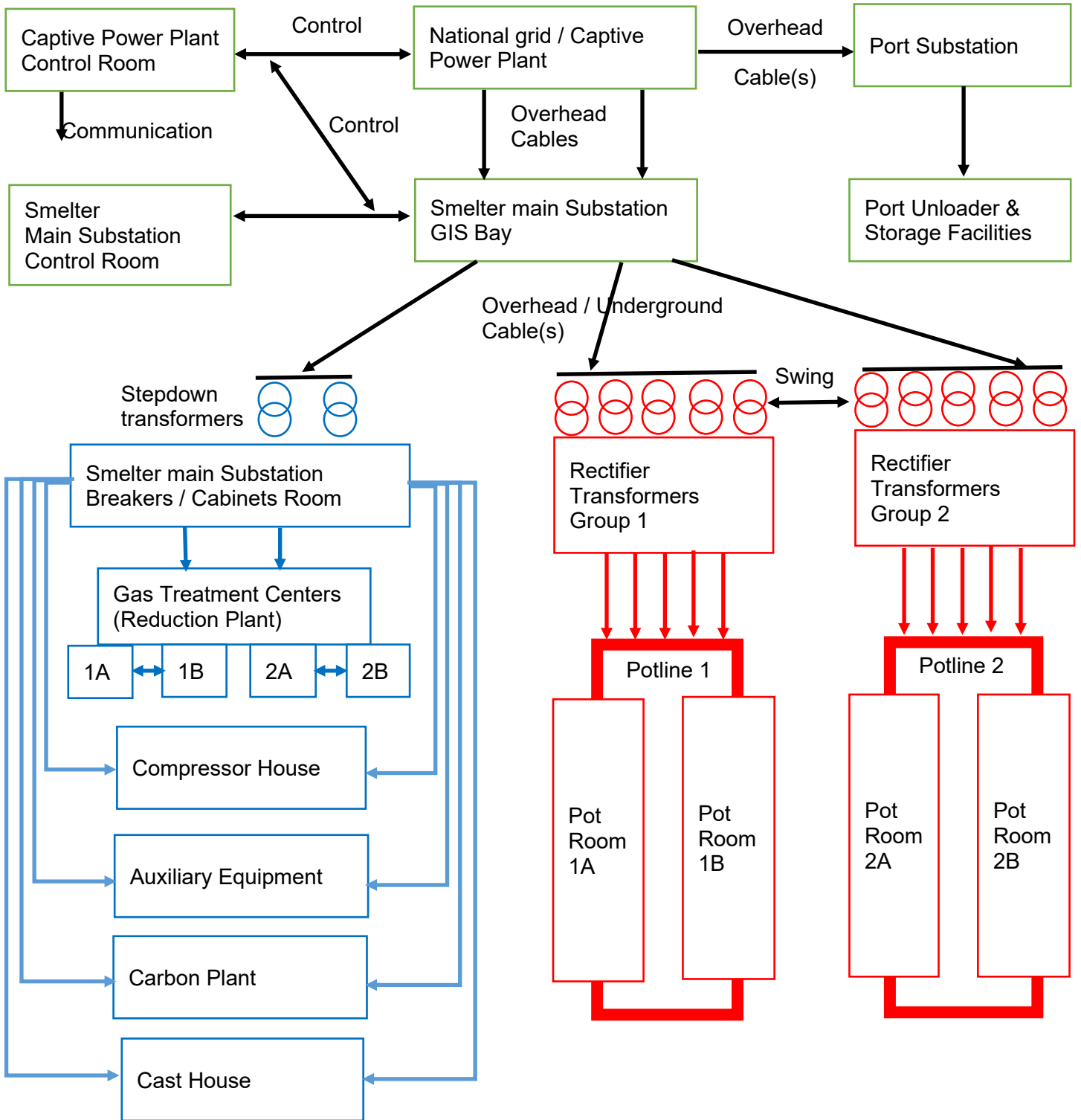



- The **DC system**, exclusively supplying the potline(s) of the Reduction Plant, is independent from the **AC system** supplying the other units of the Smelter.
- Extensive **AC bus bar systems** are provided to allow switching and load transfer between units. Recent smelters use SF6-insulated bus bar systems (Gas Insulated System – GIS).



Main Substation RTs



SF6 insulated busbar systems (GIS)



GIS Bay Cabinets

Courtesy of SOHAR Aluminium LLC

- On the **AC system** side, there is a step-down transformer (e.g. 75MVA, 380kV / 230kV). After step-down by transformers, power is transmitted via underground / aboveground cables to various plant areas including various pieces of equipment in the Reduction Plant (e.g. Gas Treatment Center) excluding the pot lines.
- The **AC system** includes substations with oil-filled transformers, breaker rooms, MCC rooms and cable vaults.
- The electrolytic cells of a smelter are supplied with a **Direct Current (DC system)** at a voltage of about 4 to 5 volts per cell, with up to 700-900 cells in series, and the amperage ranges from 80 to 500kA. A modern large smelter may, therefore, require several hundred megawatts of electrical power.
- The **DC system** feeding the reduction plant includes rectifier transformers. A Common Trip Panel (CTP) may be provided so that, in case of a fault (earth / reverse current) occurring, all RTs would trip in order to prevent an overload on any one RT (in-built safety).
- Pot lines may be provided with a magnetic field compensation system or compensation loop current, if required as per the technology installed:
 - When an electrical charge moves in a magnetic field, the magnetic field itself exerts a force on the moving charge. In the alumina reduction cells we have strong magnetic fields, generated by the high intensity electrical currents used for the electrolysis (beyond 350kA and in some test cells up to 500kA) and the electrical charges



(electrons in the metal pad and ions inside the electrolyte) moving in these magnetic fields.

- As a result, these forces induce complex movement in the electrolytes and in the molten metal, in the form of vortexes and bath/metal interface waves. All these movements have a detrimental effect on the current efficiency and specific energy consumption and it is, therefore, of paramount importance to design pots with a good magnetic compensation in order to decrease to a minimum all the bath and metal movements. Magnetic field modelling is used to optimize the metal pad profile.
- For some pots, the solution is to have a dedicated electrical circuit compensating for this magnetic disturbance.
- This compensating electrical circuit is independent from the pot line electrical circuit through which the electrolysis current flows. This compensating current flows beneath the cells in the opposite direction to that of the overall direction of flow of the electrolysis current.
- Without a compensation loop current, the Reduction Plant would operate at lower amps than standard (e.g. 6kA). This would result in a kA difference which would roughly lead – according to industry data - to a loss of production of 8kg of aluminum per kA per pot per day.
- A compensation loop facility (i.e. basically an electric room) is usually provided for each pot room # so two for one pot line).
- Some pots or a series of pot on a potline may also have an additional source of DC power through so called “booster Rectifier Transformers” allowing to operate some pots (test pots) at higher current (amps) than the rest of the potline. The Booster RTs are usually located outside along the potline building at reasonable distance for avoiding any overheating or any electric disturbance.

Prevention & Protection:

- All feeders should have adequate redundancies. Redundant feeders should be installed on different pylons with a safe separating distance between them.
- All buildings housing electrical equipment including GIS should be made of non-combustible construction material.
- Control rooms (including raised floors and false ceilings) should be protected with a total flooding clean agent safe for humans.
- In-built redundancies should be provided and well separated. These include, but are not limited to:
 - GIS bay cabinets (100% redundancy should be provided in 2 well separated 2-hour fire-rated rooms).
 - Power Transformers (at least N+1).
 - Rectifier Transformers (RT) at least N+1 per pot line. (e.g. 5 x 213kVA RTs, each providing 103kA so that 4 are needed to provide 400kA).
 - In the case of 2 reduction pot lines, each provided with N+1 RTs, a connection (“swing”) is installed in order to provide mutual backup (N+2 RTs). Mutual backup (a two-way swing) is, of course, preferred. However, some smelters are only provided with a one-way swing (e.g. the oldest pot line providing 1 RT backup for the newest line).
 - Each compensation loop facility dedicated to one pot room should have spare capacity. The best arrangement consists of having one compensation loop facility per pot room having spare capacity so that it provides 100% mutual back up for each pot room. Physical inter-connections should exist for better reliability.

Note:

Some equipment may include a relatively high level of redundancy, but is all located in the same area. For instance, bay cabinets organized with 2 fully redundant sets, fully independent from



the bus bar standpoint and physically separated (total of 13 cabinets) but located in the same room (thus in the same fire area). This is not adequate. In such cases, adequate separation and or automatic fire protection is required.

- A GIS SF6 type, equipped with a pressure on-line monitoring system, is preferred (e.g. made in Japan / Korea, from 12 up to 20-24 months replacement time). New installations should be Arc -rated and provided with an IR scanning window.
- The GIS hall should be equipped with a rolling crane parked in an area not exposing the GIS equipment. Overhead cranes should be adequately parked and detected / protected when needed, as recommended in section 11.
- All transformers should be protected and segregated, as recommended in section 11 (e.g. blast walls between transformers and automatically activated spray sprinklers). The main objective of the sprinkler protection is to allow, when possible, for repairs which should take a shorter time (e.g. 3-4 months) rather than a full replacement (e.g. 12-18 months).
- Dissolve Gas Analysis (DGA) should be provided for all oil-filled transformers. Online DGA should be considered for all main transformers (i.e. Rectifier Transformers, Power Transformers, Main Auxiliary Transformers).
- All critical electrical rooms should be protected, as recommended in section 11. Dry-type equipment is preferred.
- Obsolescence issues: spares for the oldest equipment may be difficult to find on the market. The legacy component should be removed (when possible) by replacing old systems with new systems. In some areas (i.e. Asia) OEMs are "required" to provide technical circulars/advice to users on the availability of critical spare parts and/or the availability of specific (end-of-life) models.

Compressed Air:

- At the Smelter, compressed air is used for pouring alumina into pots and for creating a vacuum used for pot tapping. Air compressors are usually electric-driven.

Prevention & Protection:

- Redundancies (N+1) and spare capacity should be provided. The air compressor room should at least be provided with an automatic fire alarm.
- Air compressors containing a large quantity of oil should be protected (from an over-postulated oil spill or compressed air foam), as recommended in section 11.

Fume Treatment:

- Fume Treatment Plants (FTP) are very critical for the treatment of fumes emitted at the Carbon Plant. As per legal requirements (environmental considerations), the Carbon Plant may not be able to operate without an FTP.

Prevention & Protection:

- Redundancies of key equipment (dual PLCs in different fire areas, at least N+1 fans) and spare capacity should be provided at the FTP.
- The electrical room should be protected, as recommended in section 11.

Gas Treatment:

- Conventional carbon anodes have a limited life-span as they are 'consumed' during the smelting process. The oxidation (or consumption) of the carbon anode creates greenhouse gas (GHG) emissions.
- For every ton of aluminum produced, several cubic meters of gases are emitted. For this reason, every reduction cell, regardless of its design, is equipped with a gas removal system that catches the gases emitted during the reduction process and directs them into a Gas Treatment Plant (or Gas Treatment Center). Modern dry gas treatment



systems use alumina to filter out toxic fluoride compounds from the gases. So, before being used in aluminum production, alumina is first used to treat the gases emitted during the earlier production of aluminum.

- The usual arrangement includes a Gas Treatment Plant/Center (GTP/C) for two halves of a pot room (# half of the pot line. See red polygon below). Each GTC houses a PLC and electrical room, fan(s) and bag filter(s).
- Gas treatment is usually compulsory, as per environmental local regulations.



Gas Treatment Center - Courtesy of SOHAR Aluminium LLC

Prevention & Protection:

- The GTCs on the same pot line should be well separated. When possible, GTCs should have spare capacity and provide some backup between pot rooms.
- Within a GTC, redundancies of key equipment should be provided (dual PLCs in different fire areas with at least N+1 fans and bag filters).
- The electrical room should be protected, as recommended in section 11.

Cooling system:

- See Cast House.

Fuel Gas supply:

- Fuel supply for the Cast House furnaces is key. Burners can be dual-fired (fuel oil / CNG).
- Gas metering / delivery / pressure reduction & filtration stations must be on site.

Prevention & Protection:

- Dual fuel oil / CNG gas-fired furnaces are preferred providing a full backup of fuel. Adequate buffer storage of fuel oil and supply should also be provided.
- Gas ducts that are well separated from the grid also provide adequate backup.



- Gas metering / delivery / pressure reduction stations should be equipped with intrinsically safe electrics (ATEX) and piping should be protected against mechanical impacts (e.g. vehicles).

2.5. Control System

Different arrangements are possible. The usual ones consist of:

- Each and every process unit / utility (i.e. Main Substation, Carbon Plant, Reduction Plant, Cast House) includes a Control Room (PLC Server Room used for both processing operations and monitoring).
- Process control can be SCADA (Supervisory Control and Data Acquisition) system based.

Prevention & Protection:

- Depending on the arrangement, cyber security and a so-called “disaster recovery plan” for IT (i.e. loss of data) should be considered.
- Server rooms: when redundant servers are provided, they should be located in different areas. In case only one server is provided, a Contingency Plan and adequate automatic fire protection system should be provided (See Rec. for electric rooms section 11).
- Control Rooms (including raised floors, false ceilings) should be protected with a total flooding system using clean agents that are safe for humans.

2.6. Spare Parts Warehouse

- Critical and very expensive spares are usually stored in one or more warehouses. Heavy spares and consumables are usually well separated. The inventory can represent several Million USD (e.g. \$20-40-60-80 Mio and more).
- These spares are critical to the process and can have a relatively long lead time. Some consumables used in relatively large quantities and/or having a long lead time are also deemed as critical. A major loss in such a warehouse could lead to BI for the related units due to lack of spares.

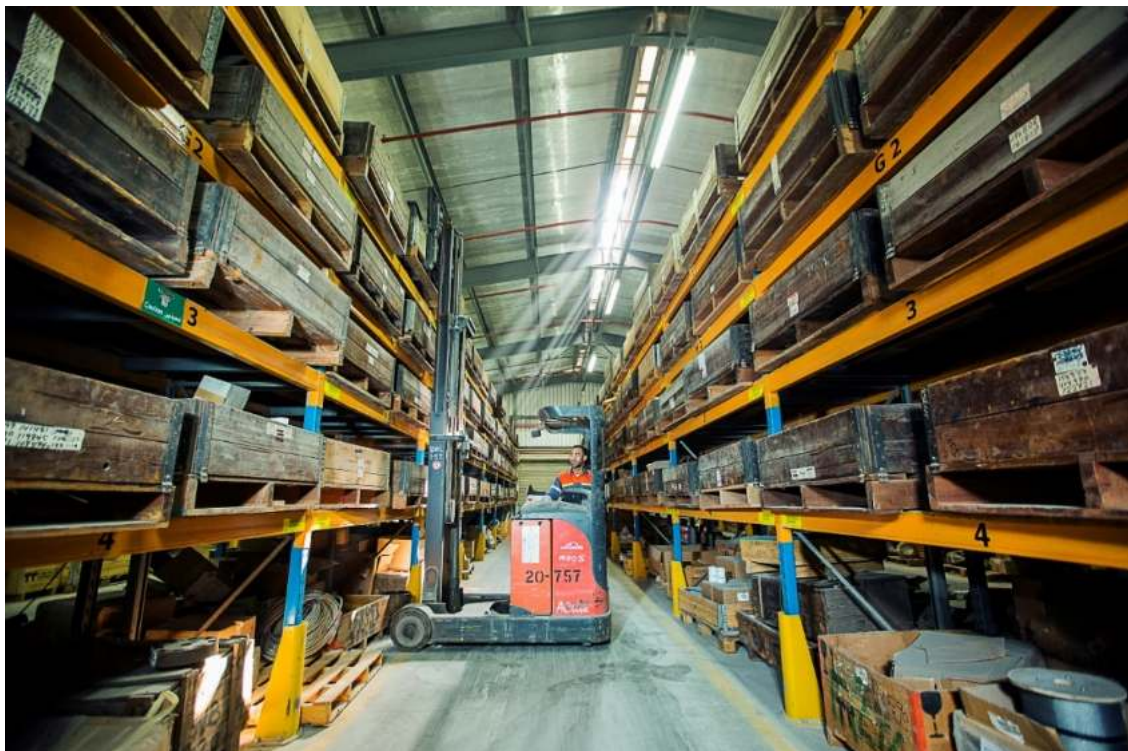

Fully sprinkler protected spare parts warehouse
Courtesy of Aluminium Bahrain B.S.C. (Alba)



Prevention & Protection:

- Critical spares should be clearly identified. The commodity class should be clearly established, as per NFPA, and the warehouse should be provided with adequate and approved automatic fire detection / protection, as per section 11.
- Flammable and combustible liquids and spray cans should not be stored in such a warehouse but rather in a dedicated safe area. Hazmat and compressed gases should be stored and protected in accordance with section 11.

3. CONTINGENCY / BUSINESS CONTINUITY / RECOVERY PLAN

Warning: in order to be reliable, Contingency / Business Continuity / Recovery Plans should be formalized. This would include formal contracts established in advance with vendors or third parties. The plans should be regularly tested, reviewed and updated.

Holistic view:

- If the Smelter is part of a group with a relatively high level of vertical integration in the aluminum industry, a Business Continuity Plan (BCP) at corporate level should be developed for the main identified risks in each and every process unit.
- The impact of a loss impacting thirds parties (i.e. logistics, utilities) should be investigated and an adequate BCP should be established.

Site view:

- Electrical Power Blackout Recovery:
 - Smelters are usually designed to ensure maximum reliability of the electrical supply to the pots to minimize chances of a general freeze-up. However, electric power failure cannot be excluded.
 - An electrical power failure may result from different causes such as:
 - Power supply failure or surge: a major event at the Captive Power Plant (fire, disintegration of GTs, STG, natural perils) or an event impacting the national grid such as an ice storm, EQ, fire in a substation feeding the smelter or the collapse of pylons.
 - Common Trip Panel (CTP) activated in case of a fault (earth) / reverse current so that all RTs on a pot line would trip in order to prevent an overload on any one RT (in-built safety).
 - Pot line trip out: due to multiple deficiencies such as a tap out, over current (e.g. incomplete installation or “shorting wedges”).
 - Load-shedding logic sequence protecting all power generating sources, consisting of the interconnection of all power generating sources through a Power Distribution System (PDS) for better reliability (redundancy) and efficiencies (control and regulation). The PDS is highly sophisticated and includes a load-shedding logic sequence. As a result, the sustainable restoration of the system after a blackout can be relatively difficult.
 - A Blackout Recovery Map for a Captive Power Plant may include the following steps:
 - Identifying the cause
 - Isolating the problem & performing a safe shutdown
 - Ensuring gas, air and auxiliary power are available
 - Generating power
 - Restoring pot line operations
- Smelter Contingency Plan (CP)
 - “Pot to Pot Emergency Bridge”:



- During normal operations: in order to isolate one cell while maintaining the continuity of the electrical series, jumpers or sections of bus bars are kept and used to electrically bypass a cell or group of cells. Short-circuiting “wedges” are usually inserted between two conductors to take an electrolysis cell offline. Incomplete installation of wedges or “shorting wedges” (i.e., less than needed) could cause overcurrent conditions overheating the wedges and creating a flashover causing damage to the bus bar and even to the overhead guide and power rail for the rolling cranes and pot line trip out. Routinely installing more wedges than the minimum required for isolation is therefore a good prevention measure.
- Purpose: In case the bus bars are damaged, an electric bridge should be installed on both sides in order to isolate the cell.
- Method: install an electric bridge at the tap end and dust end of the pot in order to isolate the pot and ensure the electric power supply continuity of the pot line.

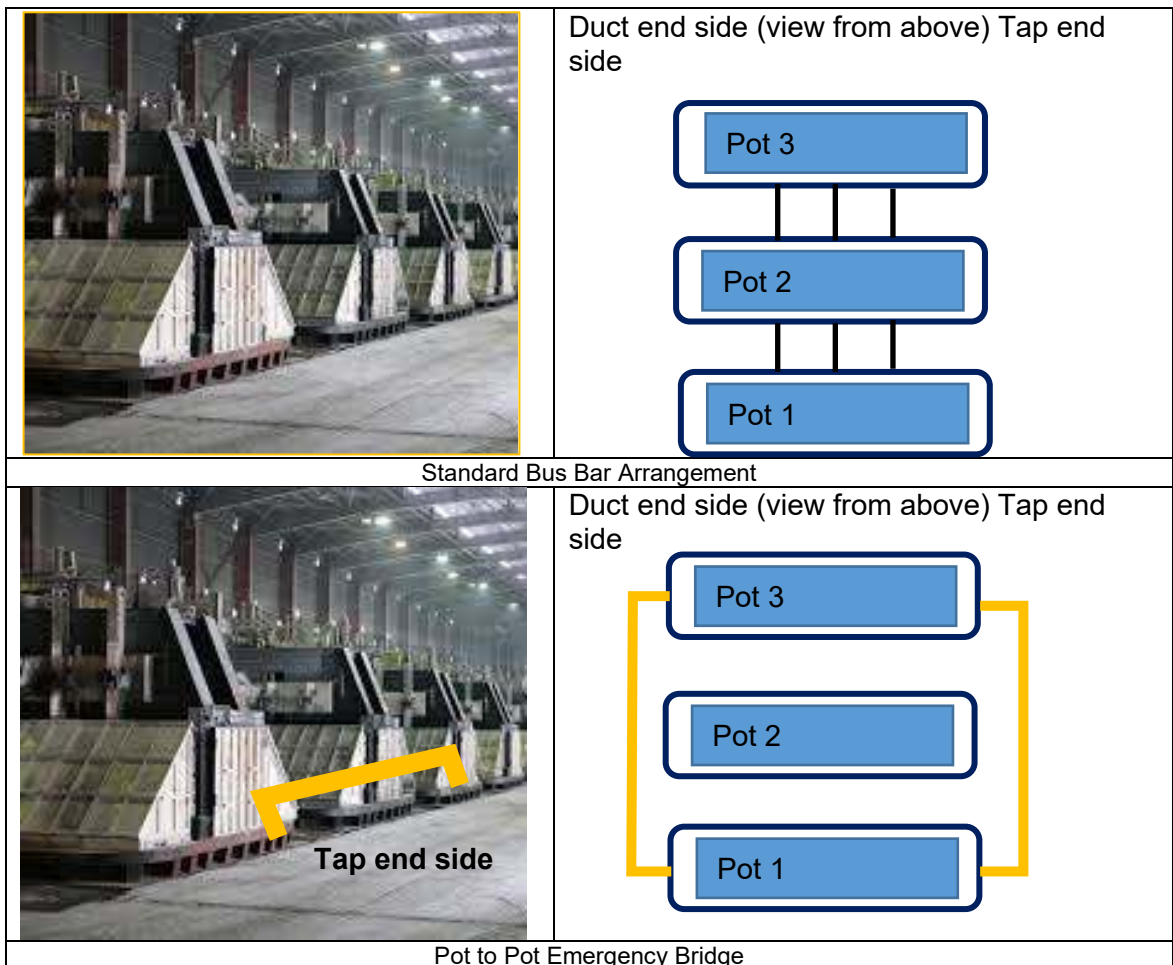

- Consider the following potential adverse conditions:
 - Multiple pots (e.g. up to 6 pots) on the line to be bypassed
 - Pot Tending Assembly (PTA) unavailable (e.g. 2.7 ton rolling crane impaired, guide rail and/or power rails damaged and/or auxiliary power and emergency Diesel Engine Driven Generator – DEDG - not available)
 - No auxiliary power available. A power source for emergency lighting and for mobile tools provided by an emergency DEDG should be constantly available at the smelter.
- Process (e.g. duration: 2.5hrs max of which 45-60min welding)



- The pre-fab bridges, (e.g. 1,600kg each, one at the tap end and one at the dust end), appurtenances and tools are carried to the pot site by an Anode Pallet Transport Vehicle (APTV) in use at the reduction plant.
 - In the meantime, concrete slabs above the pot line bus bars powering the cathode are removed using a mobile crane.
 - The bridges are put in place as follows:
 - Using a forklift at the tap end and dust end or using a mobile crane at the dust end (when there is no room for a fork lift).
- Or
- Welding pre-fab terminal bridge elements when made of multiple elements such as aluminum plates (note: this is not the usual procedure, but some smelters have developed this technic due to the lack of access and unavailability of any heavy lifting equipment for a given bridge design).



Emergency Bridge Kit



Tool box

Courtesy of Aluminium Bahrain B.S.C. (Alba)

- Maintaining High Reliability:
 - Enhancing the Contingency Plan and Emergency Preparedness as follows:
 - Considering the worst-case scenario: no cranes available.
 - Emergency pre-designed Bridge Kit available in the Reduction Plant area (in an attached building). Instructions and tool list provided.
 - Provide emergency lifting tool independent from the standard crane.
 - Ensuring regular testing and drills: regular training in welding and bridge handling.
 - Wooden bridges are used for regular training.
 - Regular welding of pre-fab terminal bridge elements (aluminum plates) done on pre-fab bridges used for training in the workshop (welders became more skilled: 40 welders certified).
- “Cross-over Re-connection”:
 - Purpose: done after a power outage due to extreme instability on the pot line (an unbalanced situation) involving several pots in excess of the “Pot to Pot Emergency Bridge” capabilities. The decision is taken to save 50% of the pots and to sacrifice 50% of the pots.
 - Method: install a cross-over bus bar isolating 50% of the pot line in order to power only 50% of the pot. The cross-over is physically installed under or along the passageway between pot rooms. The circuit is normally open during standard operations. The circuit is closed, using a hard connector, for a cross-over re-connection.

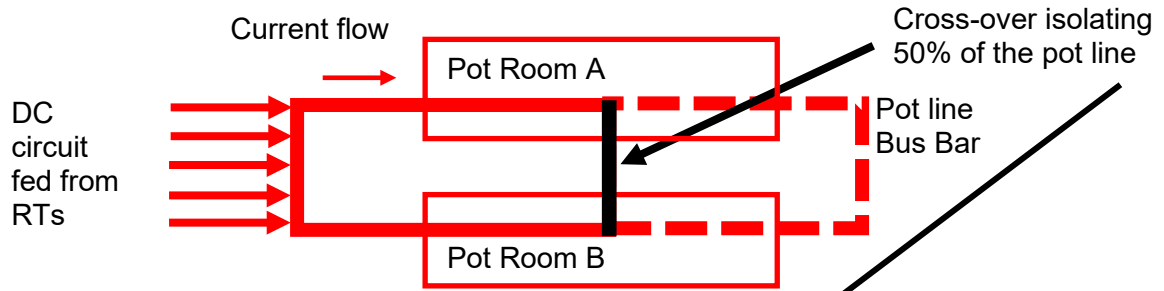

View from above:

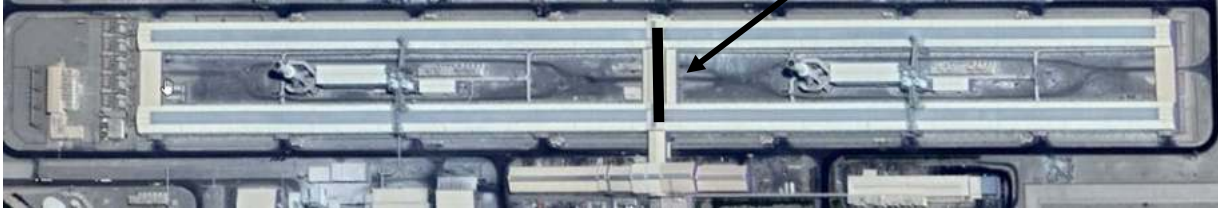

Photo: Courtesy of SOHAR Aluminium LLC

Example of a cross-over installed along the passageway:



Courtesy of Aluminium Bahrain B.S.C. (Alba)

Note:

Test Rig for Simulation Testing of Busbar Cross-Over Medium: Recent loss experiences within the industry have shown that it is important to simulate the use of this equipment so that operators become familiar with the procedures and so that set-up/connection times are manageable. It is difficult to physically and safely test the cross-overs within safe boundaries as



the bus bar assembly must be moved into position, connected and bolted. This is normally not possible during normal pot line operations. An alternative is to construct a test rig so that connection of the bus bar cross-overs can be simulated. Some smelters (e.g. in the Gulf area) have successfully constructed a test rig for simulating cross-over connections.

- **“Operating the Pot line at a Reduced Amperage/Power for a Short or Unknown Duration” procedure (# hibernation):**
 - The normal situation is for a pot line to operate with N+1 rectifier transformers, each currently delivering about 60-70% of maximum capable amperage.
 - The pot line can be operated at the required amperage with N-1 rectifiers, each one having to operate at a higher capacity percentage.
 - If 2 rectifier transformers are lost due to unforeseen circumstances, such as emergency maintenance, trip, etc., the maximum amperage that will be achieved with N-2 rectifiers will be lower than the standard operating Amps (e.g. 320kA instead of 395kA).
 - For extended periods of operating at reduced amperage/power, the pot line would experience disturbances in the various equilibria (thermal, magnetic, etc.), which would impact pot performance and possibly even lead to pot freeze. Hence a procedure should be in place for ensuring the sustainable operations of the pot line.
- **“Extended Pot Line Power Outage Procedure”:** the procedure for restarting after a pot line power outage includes the following cases:
 - Total power outage for between 1.5 and 2.5 hours – Low risk of pot stoppages (likely to occur several times in a smelter’s useful life but not normally causing serious problems).
 - Total power outage for between 2.5 and 3.5 hours – High risk of pot stoppages (may be dealt with by establishing a new working point, cell voltage and current density, and by shutting down some cells - those known to be defective first).
 - Total power outage for greater than 3.5 hours – High risk of pot line stoppage, based on the length of the shutdown:
 - When power is known to be restored within a reasonable time frame (3.5- 5hrs), install a cross-over bus bar in order to save 50% of the pots. (See “Cross- over Re-connection” above).
 - In case of a total power failure and an unknown time of restoration, initiate the “Controlled Shut Down (CSD) & Pot Freeze Recovery Strategy” below.
- **“Controlled Shut Down (CSD) & Pot Freeze Recovery Strategy”:**

Note that different strategies may be considered depending on the smelter technology and operators. Some reported strategies are summarized below:

- “Controlled Shut Down (CSD)”:
 - Raising all anodes ASAP.
 - Tapping hot metal from pots. In some smelters, this can reportedly be done up to 8-12 hours following a power outage. Tapping all pots in such a time frame is usually reported to be impossible due to tapping capabilities (i.e. availability of Pot Tending Assembly and Metal Ladle Lifting Beams), or the Cast House and Aluminum Downstream lacking capacity for handling hot metal (note that the option to dump hot metal somewhere should be prepared far in advance. A dedicated location should be identified and special arrangements should be made. Clearance from authorities may have to be granted – e.g. environmental considerations). As a result, rather than tapping all metal from some pots, tapping a lesser amount but from all pots (e.g. 4t) may be preferred by some smelters.



Note that an adequate Controlled Shut Down is key for enabling an efficient Pot Freeze Recovery below.

- “Pot Freeze Recovery Strategy”:
 - The maximum duration of an electrical supply interruption that a cell can sustain before freezing occurs varies with the design of the cell and the operating parameters. There is no consensus as to how long it will take to freeze a pot line: it is generally accepted by the industry that freezing will not occur in the first four hours following loss of electricity. The maximum allowable time certainly does not exceed five to eight hours.
 - To restart the pot, the frozen electrolyte must be physically removed or re-melted to allow the current to pass through the pot.
 - The aluminum pad obviously remains conductive, but during solidification, the metal density increases and the metal pad shrinks. This may result in damage to the pot lining and possibly to the bus bars.
 - An interruption of the electrical supply which lasts longer than the maximum allowed duration will systematically result in damages, requiring rebuilding some pots, and a reduced life expectancy for other pots. As a result, the recovery of the pot is based on aging. It is usually estimated that for a given pot line experiencing pot freeze:
 - Up to 1/3 of the pots (with a minimum of 25%): not to be rebuilt
 - Up to 1/3 of the pots: to be rebuilt (delining / relining)
 - Up to 1/3 of the pots: yet to be defined
 - There will be additional restarting costs (including anodes, electrolytes), and a lengthy interruption of production.
 - Some smelter operators consider that if the power outage exceeds 12 hours, all pots would be frozen and the pot line is almost “lost”. In such cases, a strategic decision should be taken whether or not the pot line should be restarted or not (i.e. based on economic justifications).
 - The time needed for restarting the pot line depends on different factors such as (but not limited to):
 - Number of pots on the line (e.g. 240 vs 710)
 - Manpower available (contracts need to be signed in advance)
 - Number of pots to be rebuilt vs de-lining / relining capabilities (e.g. in house de-lining turn over limitation of 3 days per pot and alternate external capability when exist to be considered).
 - Availability of materials and supply chain (e.g. refractory, cathodes: procurement needs to be secured in advance):
 - Stock of Raw Material on site (i.e. cathodes and refractories available on site equivalent to 25 pots)
 - Refractories (pots): Lead time for pot refractories (from order to delivery standard and current considering supply chain issues such as pandemic, geopolitical situation and market demand): 3-5 months (mainly vendors in Europe and Asia)
 - Lead time for cathodes (from order to delivery – standard and current considering supply chain issues due to covid and market demand): 5- 6 months (up to 9 months during pandemic for some type of cathodes) from placing the order to delivery (mainly vendors in Europe and Asia)
 - Availability of molten material and/or diesel engine-driven heating systems (see Hot Start method below)



- Restart sequence:
 - All pots at once when rebuilt (“**All in One**”).
 - Restarting some pots once rebuilt (“**Batch after Batch**”). For a standard start (cold start): the batch can correspond to a maximum of 1 pot every 2 days (#15 per month). In the best case for a crash/dry start, between 2 up to 10-15 pots/day can reportedly be restarted and between 10-15 pots/month when based on rebuild capacity. The batch may consist of the portion of the pots powered by the cross-over (#50% of the pots on one line so that the pot line will be restored in 2 batches). The time needed for restarting the batch depends on the rebuilding capacity (time needed to restore the number of pots powered by the cross-over. i.e. 15 pots per month rebuild capacity and cross-over section including 90 pots: $90/15=6$ months restart for one batch of 90 pots).
 - See example of comparison of restart sequences on the following page for a pot line including 360 pots in 2 pot rooms (180 pots each), each provided with a cross-over dividing the pot rooms into 90 pots each. (Spreadsheet: © Didier Schütz - DLS)

Pot Freeze Recovery: "Batch After Batch" VS "All In One" Restart Mode								
		Loss Expectancy		Loss Expectancy		Loss Expectancy		
		Batch Recovery every month:		"All in One"		Batch Restart		6
		Periodicity (x months):						
Business Interruption- USD:	500 000 000	PD USD	162 000 000	PD USD	162 000 000	PD USD	162 000 000	
BI Indemnity Period (month):	12	Extra Cost (5%)	8 100 000	Extra Cost (5%)	8 100 000	Extra Cost (5%)	8 100 000	
BI per month:	41 666 667	BI USD	520 833 333	BI USD	1 000 000 000	BI USD	625 000 000	
Total Number of pot to be rebuilt (MPL#100% of pots):	360	BI 100% equivalent duration (month)	12,50	BI 100% equivalent duration (month)	24	BI 100% equivalent duration (month)	15,00	
Cost of pot recovery (including de-lining - relining, anode and cathodes) - USD:	450 000	Total PD & BI:	690 933 333	Total PD & BI:	1 170 100 000	Total PD & BI:	795 100 000	
Rebuilt capacity (pot per month):	15	(basically de-lining / relining)						
Total Recovery Duration (month):	24	(Based on rebuilt capacity)						
Restart Batch Size Limitation (pots):	90	(0 when based on rebuilt capacity. <>0 when based on batch i.e. use of cross over for restarting 50% of the pot)						
Batch Restart Periodicity (x months):	6	(0 when based on rebuilt capacity. <>0 when = restart batch size (pots per batch) /rebuilt capacity (pot per month))						
Calculation details (batch recovery every month):				Calculation details (batch recovery other than every month):				
Month:	BI %	BI month (USD)	BI Total (USD)	Batch	Month	BI %	BI month (USD)	BI Total (USD)
1	100%	41 666 667	41 666 667	1	6	100%	250 000 000	250 000 000
2	96%	39 930 556	81 597 222	2	12	75%	187 500 000	437 500 000
3	92%	38 194 444	119 791 667	3	18	50%	125 000 000	562 500 000
4	88%	36 458 333	156 250 000	4	24	25%	62 500 000	625 000 000
5	83%	34 722 222	190 972 222	5	30	0%	0	0
6	79%	32 986 111	223 958 333	6	36	0%	0	0
7	75%	31 250 000	255 208 333	7	42	0%	0	0
8	71%	29 513 889	284 722 222	8	48	0%	0	0
9	67%	27 777 778	312 500 000	9	54	0%	0	0
10	63%	26 041 667	338 541 667	10	60	0%	0	0
11	58%	24 305 556	362 847 222	11	66	0%	0	0
12	54%	22 569 444	385 416 667	12	72	0%	0	0
13	50%	20 833 333	406 250 000	13	78	0%	0	0
14	46%	19 097 222	425 347 222	14	84	0%	0	0
15	42%	17 361 111	442 708 333	15	90	0%	0	0
16	38%	15 625 000	458 333 333	16	96	0%	0	0
17	33%	13 888 889	472 222 222	17	102	0%	0	0
18	29%	12 152 778	484 375 000	18	108	0%	0	0
19	25%	10 416 667	494 791 667	19	114	0%	0	0
20	21%	8 680 556	503 472 222	20	120	0%	0	0
21	17%	6 944 444	510 416 667	21	126	0%	0	0
22	13%	5 208 333	515 625 000	22	132	0%	0	0
23	8%	3 472 222	519 097 222	23	138	0%	0	0
24	4%	1 736 111	520 833 333	24	144	0%	0	0



Each electrolytic cell designer and/or smelter operating company has developed a pot restarting procedure depending on cell design, workers' availability (manpower) and electrical energy availability (restoration of power supply). Some of those strategies are summarized below:

Strategy 1:

- Normal condition restart (so called "Fresh Start")- for instance for a smelter including about 720 pots.
 - Planning to reline 25% of the pots (180) thanks to an adequate CSD, described above - (raising all anodes ASAP, tapping hot metal from all pots up to 8-12 hours following the power outage).
 - For other pots: remaining frozen metal to be removed manually.
 - 310 days (#10 months) duration, considering delining (about 21 pots per month in a single stand) / relining capacity (maximum of 17-18 pots per month in 5 stands).
 - "All in One" normal restart conditions.
- The key to success includes (but is not limited to):
 - The Reduction Plant Leader having full authority for any decisions relating to the activation of the Recovery Plan (including CSD) (e.g no need to ask for CEO clearance).
 - Additional resources, representing #450 people, provided by 2 existing contractors supplying most of the skilled labor – contracts already signed.
 - Maintaining a stock of refractories equivalent to 40 pots (about 2 months relining maximum) and having a contract with a supplier for delivery within 30 days of refractories corresponding to about 30-40 pots.
- Note that without this recovery plan, any restart after a pot freeze would reportedly take up to 18 months or even up to 600-700 days if the anodes are not raised on time and at least 25% to 50% of the pots would have to be relined.
- Neither "dry start" nor "metal start" technics foreseen. Deemed as non-proven at an industrial scale.

Strategy 2:

- "Dry start" and "metal start" technics - For a smelter including about 360 pots:
 - Planning to reline less than 5% of the pot (<18) thanks to adequate raising of all anodes ASAP.
 - About one and half months used for cleaning and for preparing the recovery.
 - 4 months duration prior to a gradual restart (Batch after Batch) and full production within 6 months' time (#180 days).
- Technics: instead of relining the pots and proceeding to a conventional restart (24 hrs duration per pot) consider 2 alternate restart methods as follows:
 - **"Metal Start ("Crash Start" or "Hot Start")**: method reportedly suitable for the oldest pots consisting of heating the solid bath in the pot up to 700°C using diesel-fired burners (24 burners purchased in addition to 4 available at that time on site); then adding about 26 tons of molten sodium hexafluoro aluminate (Na_3AlF_6) # cryolite (taken from other baths being heated). Molten cryolite is an effective solvent of alumina and has good electrical conductivity in the molten state. Then, applying a current via the anodes at less than <100kAmps (allowed as per the design for this smelter) for some time then waiting for 30-40min (restoring conductivity) before applying the current again. The restart process of about 4 pots per day was initiated (full



restart takes 3 days for a given pot) with a total of 218 pots restarted that way and reportedly only 5-6% of failure.

- **“Dry Start” (or “Soak Start”)**: method reportedly suitable for 6-month-old pots (max) consisting of positioning the anodes above the solid bath, adding solid sodium hexafluoro aluminate (Na_3AlF_6) # cryolite, applying a current for 1 day in order to heat the solid cryolite until it melts, then adding molten cryolite (taken out from another bath being heated). The restart process of about 9 pots per day is initiated (full restart takes 1 day for a given pot).
- *Main advantages of the 2 above methods*: this saves about 45 tons of Al per pot, as well as cathodes and time for demolishing the side walls (6 days at 24 hrs work per pot needed). Moreover, no cranes are needed (i.e. in case of guide rail damage leading to major impairment of cranes).
- Key to success:
 - Adequate sustainable resumption of power supply (in case of blackout).
 - Top quality anodes (no cracks reportedly noticed).
 - Manpower available to be contracted for cleaning. People unfamiliar with the smelter environment must be given training and adequate supervision.
 - Support from external experienced staff, knowledgeable in pot freeze recovery using “non-conventional” methods.
 - Adjusting decisions on a day-to-day basis depending on the situation.
- Limitations of the 2 methods above:
 - Reportedly not suitable for large operations since they require a lot of manpower for material handling, supervision and process parameter adjustments.
- Note that other methods (or a combination of several) can be used as follows:
 - **“Cold Start”** method: the anodes must be lowered to within about 13 mm of the metal pad prior to freezing. At the time of restarting, full line voltage is applied to only about 10% of the cells in a pot line. The full line voltage is applied on these pots until it can be determined whether or not there is any current passage across the frozen electrolyte, which is a good insulator but not a perfect one. If no passage of current occurs, then more cells are taken out of the circuit and another cold start is attempted. Once a current passage is achieved and generates sufficient heat to melt some electrolyte, the anodes can be raised to increase heat generation. Then colder electrolyte is added and melted after which it can be transferred to other pots for hot starting (see “hot start” above).
 - If a smelter operates several pot lines, and not all of them have been shut down and frozen, then the still-operating pot line or pot lines are used as a source of hot bath to restart the others.
 - Once enough hot bath has been generated from cells restarted using either the soak start method (see above) or the cold start method (see above), all other frozen cells are restarted using the hot start method.
 - **Another “Hot Start”** method uses molten metal instead of hot bath. The cell cavity is cleaned down to the metal pad and new anodes are raised to 100–150 mm above the metal pad. Molten metal (at around 900°C [1650 °F]) is poured into the cell until the metal surface is flat. The cell is then energized and “bathed up” according to standard methods.



- Carbon Plant Risk Mitigation:
 - Fire hazards tend to be more significant in a carbon plant. Fuel loading in a carbon plant can include Heat Transfer Fluid/Media (HTF/HTM), process materials (petroleum coke and pitch) and hydraulic fluid, which, when combined, can support a large fire. The light structure made of exposed metal members would expectedly collapse. Up to 21-24 months reinstatement could be expected for some smelter operators.
 - When two paste lines are provided, the preferred arrangement consists of two well separated paste lines in different fire areas (refer to the MPL Handbook for safe separating distances considering combustible construction: i.e. open structures involving a high combustible load) rather than two paste lines in one single paste plant structure. This prevents mutual exposure and total loss of the paste plant in case of a fire starting on one paste line and spreading to the others. The provision of an adequate fire wall (4 hours) aiming at separating two mutually exposed paste lines is virtually impossible considering the height of the structure and the penetration necessary for structural members, piping and cable trays. Moreover, some equipment may be common to both lines (e.g. compensation liquid pitch tank).
 - Dedicated Disaster Recovery Plan based on major fire at the paste plant would include:
 - Using buffer stock on site: usually corresponding to 20-30 days (up to 40 in some cases) of Reduction Plant operations based on average anode consumption (e.g. 540 rodded anodes per day) and split as follow: (numbers given as an example)
 - Rodded anodes (e.g. 1,600 #3 days).
 - Baked anodes (e.g. 6,000 #12 days)
 - Green anodes (e.g. 6,000 #12 days – paste plant inventory)
 - Work in Progress (e.g. 8,500 #15 days - baking furnace)



Buffer storage of rodded anodes near the cast house
Courtesy of Aluminium Bahrain B.S.C. (Alba)



- Benefitting from mutual aid given by other aluminum smelters in the area (e.g. Gulf Aluminium Council). However, aluminum smelters may use different types of technology and different types of anodes as well. As a result:
 - The other smelters could supply anodes with the same characteristics from their buffer storage (i.e. providing up to 1.5 months #45 days operations in some cases)
and/or
 - Molds from the damaged Carbon Plant could be designed in advance (and stored in a safe location) to be used at other carbon plants which could produce anodes (process adjustments to be done) for the smelter with no Carbon Plant.
and/or
 - Anodes of a different size could be used at the smelter (to be investigated in advance).
 - Note: having back up mold(s) stored in safe location is highly recommend.
- Alternate Supplier (mostly in China and some in Europe):
 - Formal agreements should be settled in advance.
 - Cost can fluctuate a lot (e.g. 2019: USD550 and 2018: USD660 per ton)
 - 3-4 months (#90-120 days) delivery time from order reported. (Note that the best arrangement for anode procurement would consist of alternate suppliers able to fabricate any molds and begin producing anodes within the time frame the reduction plant can maintain operations using its own buffer stock.)
 - The total process could take up to 6 months before obtaining a full supply.
- In the meantime, (prior to delivery from the alternate supplier) the operating smelter could reduce its consumption of anodes (lower amps) providing additional operating days (e.g. 27 - 35 days max. of operations in some cases). Note that the quality of the aluminum product may be impaired (e.g. high iron rate), especially when certain periods are exceeded (e.g. 27 days).
- Material Supply Risk Mitigation:
 - A sunken vessel in the access channel could lead to a potential port blockage (for unloading RM: alumina, pitch, and coke).
 - Alternate ports should be considered. However, some equipment such as unloaders may not be available.
 - As a result of the above, the following buffer storage is critical. Storage capacity - at the port, on site, shipments per month, potential redundancy shipments, voyages at sea and monthly consumption - should be clearly established (numbers given as an example only):
 - Alumina
 - Port: 2 silos (# 30 days production)
 - Smelter: 1 silo (#10 days production)
 - 1 shipment per month (capacity 40kt)
 - Monthly consumption approx. 45kt
 - 1 shipment's redundancy
 - Voyage by sea: approx. 3 to 4 weeks
 - Coke
 - Port: 2 silos (# 45 days consumption)
 - Smelter: 1 silo (# 10 days at Carbon Plant)
 - 1 shipment per month (capacity 10kt)



- Monthly consumption approx. 10kt
- 1 shipment's redundancy
- Voyage by sea: Approx. 28 days (US) and 3 weeks (China)
- Pitch
 - Port: 2 tanks (#15 days consumption)
 - Smelter: 300t/day tank (#3 days consumption)
 - 1 shipment every two months (capacity 4kt)
 - Monthly consumption approx. 3kt
 - 1 shipment's redundancy
 - Voyage by sea: approx. 3-4 weeks (from China)

4. LOSS HISTORY

4.1. Power outage due to loss of single feeder

1991: The loss of a single feeder running from the national grid substation to the smelter main substation resulted in a 12-hour power outage and pot freeze of all 4 pot lines. 340 pots had to be delined/relined. A successful liquid start was reported for the others. 13 pots per day were restarted.

Preventive measures: installation of an additional feeder for better reliability.

4.2. Power outage due to ice storm impacting national grid

2008: A snowstorm (100-year return period) resulted in a major blackout of the southern grid. The Aluminum Smelting Factory was shut down for 2 weeks due to the power failure, resulting in a pot freeze of all electrolysis cells (more than 800 in 4 units). The anodes were raised to a safe position in order to limit the loss. Two months were needed to remove all frozen Work in Progress material (manually) and to restart the process. This salvage and recovery operation was also supported by the government. About 1/4 of annual production was reported lost.

4.3. Fire in paste plant

2016: A fire broke out in a Paste Plant involving HTM leakage and ignition due to a skip bolt problem (just 1 bolt missing) at a coupling flange in the pre-heater section. The fire was controlled by the fire brigade.

Preventive measures taken: the bolting procedure was reviewed and enforced. Additional flange protection was installed as well as a system for securing the bolts in place.

4.4. Power blackout due to human error & in-built safety

2017: Human error during maintenance operations resulted in the accidental shut down of the gas compressor unit for the Gas Turbine (GT). The gas compressors were fed from 2 feeders from different switch houses feeding different pot lines (2 pot lines out of 5 existing; A, B, C, D and E). The loss of gas pressure initiated a de-loading sequence (uninterruptible as per design) for one Power Station and the subsequent tripping of another Power Station and all 5 pot lines as per design (everything being interconnected through the Power Distribution System).

The power outage lasted 2.5 hours. The power was restored to the pots right after the power supply was restored. While restarting the pot lines, several pots could not be stabilized and were cut from the lines.

About 11 hours after power restoration, a pot went into an open circuit causing damage to a bus bar. Electrical power was interrupted to pot line A where the open circuit occurred. After repairs restoring the electrical power supply, pot line A could not be stabilized and the decision was made to take 20% of the pots out of service. As the operator worked to stabilize pot line A, additional pots were taken out of service (about 80%). Pot line A was back in operation 6 months after the pot freeze.



Further investigation showed the following:

- The site is fed from different power sources in order to ensure high reliability of the power supply.
- All power-generating sources (power station, grid - excess of power available) are interconnected through the Power Distribution System (PDS) for better reliability (redundancy) and efficiency (control and regulation).
- The integrity of the PDS is ensured through a series of built-in interlocks linked to control supervision hierarchy and the command computer which interrogates local computers or Programmable Logic Controllers (PLCs).
- As a result of the above interrelation within the PDS, the activation of one interlock can lead to multiple trips of other protection elements and, in the worst case, to a general power outage.
- Due to the high level of sophistication of the PDS, the sustainable restoration of the system after a black out can be relatively difficult (minimum of 2 - 2.5 hours) as the identification of the common cause can be challenging. This is especially true when it is the result of human error together with non-appropriate setting of interlocks.
- Moreover, the power outage and restoration of power supply were reportedly responsible for anode failure and a non-uniform distribution of the current in the cells leading to an open circuit (local explosion), damage to bus bars and subsequent pot freeze. This can occur even 2 to 4 weeks after the restoration of the power supply.

Moreover, some time after restoration, quality issues were still being reported, due to a high iron content in the hot metal being produced on other pot lines, which led to an open circuit on some pots (so called sub-events).

According to some smelter operators, the common cause of the above sub-events is reportedly the power outage rendering the potlines more fragile (surface alteration of the aluminum bed, anode failure and subsequent loss of conductivity) and prone to non-uniform power distribution and open/short circuit events leading to a potential pot freeze.

Lessons learned & prevention mitigation measures taken:

- At the level of the Power Plant: modification of the de-loading logic sequence:
 - Possible interruption of de-loading when the abnormal condition is cleared up.
 - De-loading sequence will start on only one block of GTs/STs and not 2 blocks at once.
 - Enhancement of maintenance procedures (in order to prevent any human error, such as performing maintenance operations on the unit on duty instead of on the standby one).
 - Procedure in place for reducing blackout duration (map for restoration).
- At the level of the pot lines: new procedures have been established:
 - in order to upgrade their emergency response in such a situation.
 - involving better communications for ensuring prompt availability of manpower.
 - and having emergency bridge kits available on pot line sites.

4.5. Power Outage due to setup of feeder circuit breakers

2017: A total power outage occurred due to a flashover in the capacity bank disconnect switch. Further investigations conducted showed a combination of 2 conditions:

- The hot spot 'ON' switch was not detected due to IR scanning being postponed (an on-going job was underway on the roof and the canvas protection above the equipment prevented access).



- “Missed protection coordination” (faulty design) caused tripping of the 2 incoming 230kV feeder circuit breakers (the cross trip was due to the relay configuration).

Preventive measures taken: a relay configuration review was carried out with the manufacturer in order to prevent cross trips (as part of an MOC).

4.6. Multiple pot failure

2017: Tap out (leakage) of a pot noticed, requiring shorting (isolating) the cell by installing wedges (a routine procedure). However, the incomplete installation of “shorting wedges” (4 out of 6 only) caused an overcurrent on the installed wedges, overheating and subsequent flashover about 6hrs after the bypass, which, in turn, caused damage to the bus bars and the overhead guide rail for the cranes. The power supply of the whole pot line tripped out.

A pre-designed bridge (emergency procedure to restore power) was, therefore, to be installed on both sides of pot A101. However, without a crane (guide rail damaged), the installation of one bridge on the tap side was done using a forklift, but the same could not be done as easily on the dust side (no access), leading to a further delay.

The power supply was finally restored about 6 ½ hrs after the flashover. It was too late to save all pots.

The decision was made to install a cross-over bridge attempting to save only half of the pots. This operation was made very difficult because of accumulated charges on the line.

Problems of stability on the line then occurred, leading to short circuits, at which time the decision was taken to conduct a controlled shut down of the line as conditions were considered unsafe for employees.

This led to a pot line freeze. Several anodes were raised (but not all).

Most Likely Cause:

- Multiple issues that had to be dealt with (multiple leakages – pot quality issues) were reported at the time of the event resulting in extreme work overload conditions for the staff who were unable to identify priorities anymore. (See preventive actions taken after recovery below).

Recovery:

- It took about one and a half months to clean and prepare for the recovery which took place within the next 4 months.
- About 1,000 people were contracted for cleaning. Training for those unfamiliar with a smelter environment had to be given.
- The decision was made that instead of relining the pots and proceeding to a conventional restart (24-hr duration per pot), they would consider 2 alternate restarts; a “Metal Start (Crash Start – technology allowing for such technics to operate below 100kA)” and a “Dry Start”.

Preventive actions were taken after recovery that basically consisted of a procedure for monitoring cell quality.

The main objective was to limit/prevent the number of issues arising that the staff would need to deal with, especially multiple leakages due to pot quality issues. (This reportedly resulted from “routine” based operations. Routine is perceived as “killing” risk awareness).

4.7. Fire Event at Power Substation

2020: A short circuit occurred within the rectifier cable vault of a pot line, leading to an internal fault in the grounding transformer, with tank rupture and fire spreading to the panels installed in the basement.



The actuation of the overcurrent protection of the grounding transformer caused the main transformer of the power substation to shut down (no AC) and consequently the shutdown of the pot line, paste plant, baking furnace, rodding shop, Cast House and utility compressors.

Pot line production stopped after a prolonged power interruption caused a pot freeze.

The main contributing factor to this major power outage was the loss of several cables in the basement (weak point) due to fire preventing the use of the power substation back-up transformer.

Aggravating factors included:

- An unsealed cable opening between the grounding transformer room and the cable vault.
- Lack of passive / active protection within the cable vault (more than 4 hours manual fire-fighting in the cable vault).
- The back-up grounding transformer was located in the same building as the primary one, without any segregation between them, so that both were damaged by the fire.
- Lack of a ventilation interlock allowed a 2hr supply of oxygen to the fire.

The root cause investigation showed an internal failure of the grounding transformer (coil displacement due to a short circuit) and tank rupture (structural failure of the tank / lack of containment or failure in the sizing or positioning of the relief device foreseen) allowing oil on fire to spread into the basement.

4.8. Pot Leakage damaging the busbar resulting in power loss

2020: A pot leakage in a potline from an “abnormal” and unstable pot that had been restarted 3 days prior, damaged the busbar resulting in power loss and controlled shutdown and loss of 61 pots. The power outage period lasted for around 5hours, with no amperage available to the line during the first 2.5 hours before the line crept back up to normal amperage after the Power plant re-energized the supply once the line was reinstated. Of the 61 pots, 8 were relined as they were older pots, and 53 were re-started over a period of 51 days. The 53 re-started pots are not showing any problems, though in the longer term a reduced life span may be expected. As a result of that incident, pot re-start acceptance procedures were reviewed and made more robust, with additional questions/checks added to the process.

4.9. Bus bar failure resulting in power loss

2021: Test potline incident: damage noticed on bus bar (melted) at a pot causing 3 hours power interruption to the main potline and to the test potline (the main line feeding the test potline). 7 pots of the test potline were lost. 44 pots of the test potline were damaged of which #30% had to be delined / relined and the other were restarted. Both potlines were back on line 3 months later. Delay reported due to covid related manpower shortage.

Circumstances:

- Note the test potline is the only one having a compensation loop.
- Note that the bus bars at this smelter are enclosed in a tunnel equipped with air cooling blowing fans maintaining temperature below 130°C (compared to other smelters where bus bars are enclosed in tunnel only at RTs levels). The temperature itself was not monitored. Only the fans operating status was monitored.

Measure taken:

- 2 consultant were appointed recommending the following:
 - Inspection of all bus bar (condition)
 - Simulation of air flow of ventilation inside the tunnels
- Project to install of Temperature monitoring system on the bus bar



5. LOSS EXPERIENCE ANALYSIS

5.1. Smelter loss origins

According to some studies available on the market (multiple sources), smelter losses over the last 30 years are attributed to:

- Electrical equipment breakdown (70%)
- Service Interruption (20%)
- Molten metal release (tap out # 10%)

Electrical breakdowns involve:

- DC power supply equipment (regulating, rectifying, or regulating-rectifying transformers) that are responsible for the majority of the electrical breakdowns. However, no pot freeze noticed thanks to N+1 reliability, or equipment contingency planning (e.g. on-site spares).
- Step-down transformers receiving or distributing power on site constitute the second origin of losses. Again, no pot freeze thanks to N+1 reliability, or equipment contingency planning (e.g. on-site spares).
- Control equipment, switchgear and cabling for the other losses. Again, no pot freeze.

Service Interruption will depend on the power source:

- See Loss History “Loss at Smelter due to Service Interruption” in Utilities (Power / Water) Focus, section 11.

Molten metal release (tap out):

- Pot quality issues.
- Mechanical impacts.

The information included in the following sub-section was provided by Charles Philippe Decori, Global Practice Leader for Property Claims, SCOR Global P&C.

5.2. Electrical interruption observed in SCOR’s Claims History

The electrical interruptions observed in SCOR’s claims history were caused by:

- malfunctions located at the power plant
- trips at the pot level
- restart after maintenance

These “initial” events are always followed by **Anode Effects (AE)** at the pot level:

- An AE occurs when a cell deviates from its normal operation, and is characterized by a sudden increase in voltage due to the anode being virtually separated from the electrolyte by a gas film.
- During an AE, the normal reactions that produce aluminum are interrupted and other electrochemical reactions take place with the formation of gases (CO, CF₄ and C₂F₆). These gases form bubbles that adhere to the anode bottom, creating an electrical insulating layer causing an increase in the voltage of the cell.
- When an AE occurs, the operating response is to restore the level of alumina concentration in the cell as quickly as possible and then remove the layer of gas on the anode bottom. In a modern pot with an automated control system and point feeders, the computer detects an anode effect when the voltage rises above a pre-set voltage. Once detected, the control system starts an overfeeding of the pot, and the anodes are moved up and down to dislodge the build-up of gas.



- The main control parameter is the electrical resistance of the individual cells. This is measured by the pot controller who adjusts the anode beams to control the separation of the anodes/cathodes to maintain resistance.

The stabilization of the pot line is complex. It is combined with the risk of pot explosion and an **extremely toxic** gaseous emission of hydrogen fluoride (“HF”) which makes any human operation more dangerous and complex. In all cases, the loss is confirmed when the insured fails to stabilize the pot line. In some cases, it was clearly identified that the failure to restart was reinforced by the failure to follow standard operating procedures.

5.3. Major Pot Freeze Comparison

Between 2009 and 2017 (8 years,) there were 5 major pot freeze losses (see details in the matrix below) representing a global loss of USD 900Mio for the market). The loss amount was mainly BI-driven. The estimated Insured’s average loss retention was usually around 10%. Four of these losses occurred in the Middle East and one loss occurred in USA just before the closing of the last US Aluminum plant.

Smelter:	Smelter 1	Smelter 2	Smelter 3	Smelter 4	Smelter 5
Loss Summary	<p>Trip of the inter-connector between the Captive Power Plant and the national grid triggered by a single-phase fault in a transformer at the nearby national grid Power Plant where the inter-connector from the Captive Power Plant is connected to the national grid. This initiated a trip of lower-rated voltage circuits at the Captive Power Plant including the 400V system providing power to the auxiliary plant of two of the three gas turbine generators that were in operation. This initiated a trip of these units and so resulted in an overload on the third unit, which tripped on under speed.</p>	<p>During the construction stage, there was a high voltage anode effect on a pot. Anode Bridge was raised. Power was interrupted by operator and later restarted. Open circuit protection operated automatically. After several restarts and interruptions, the situation was stable 6 hours later. The day after and 2 days later, the line reached high voltage several times. Emergency power trips took place more and more frequently, and several pots had to be shut down. Rather than continuing with multiple failures and increased risk of pots going to open circuit, the decision was made to shut down the line.</p>	<p>Maintenance operations were being conducted on the main breakers. The tie switch then engaged to keep power flowing temporarily until the main breaker could be re-energized. The operator was unable to restart pot lines #1 and #2 in a timely fashion. The operator worked to re-route incoming power to pot line #2 to prevent it from being shut down. Despite their efforts, they could not stabilize the power being fed to Pot line #2 and they were forced to take it offline. When the main breaker was re-energized the tie switch failed to engage. An arc short occurred causing a fire and damages which necessitated shutting off the power to Lines #1 and #2.</p>	<p>The incoming supply from the station transformer tripped for unknown reasons. This resulted in a chain of events which caused the trip of the Gas Turbine and the 5 pot lines. During power restoration the smelter operator met with difficulties in stabilizing the pot line and several were cut out. The following day, when working to stabilize the pot lines, additional damages to transition joints occurred. Four days later, the operator decided to cut out all pots that were not in the operating range (336 pots, or 84% of one line out of the 5 pot lines).</p>	<p>Flashover occurred on the duct end side of a pot where wedges were installed. The overhead crane rail, the adjacent wall structure and the bus bars at both ends of the pot were damaged. This left all pots without power. The operator mobilized resources to install a bridge across the damaged bus bar and to install a cross-over as a fallback position to reenergize and save half of the pots. The pot bridge was successfully installed but not the cross-over. The power supply to the pot line was restored but, by that stage, the pots had been without power for about 6½ hours. An increasing number of clad failures on the anode hangers culminated in an open circuit on a pot which caused a major short circuit and flashover. The decision was made to shut down operations.</p>
Cause of the loss (most likely)	<p>Malfunction at the power plant: Trip of the interconnector between the</p>	<p>Trip at pot level: Initial anode effect on a pot followed by an increasing</p>	<p>Unknown</p>	<p>Malfunction at the power plant: Transformer tripped</p>	<p>Trip at pot level: Explosion of the wedges of one pot caused damages</p>

Smelter:	Smelter 1	Smelter 2	Smelter 3	Smelter 4	Smelter 5
	national grid and the Captive Power Plant which resulted in a trip of the smelter gas turbine generator.	number of high voltage episodes on the pot line which led to shutting it down.		causing a preliminary short shutdown. During restoration, the power pot line could not be stabilized and the decision was taken to shut down the pot line.	to the buildings and crane, and to the pot line bus bar.
Number of Damaged pots	444 out of 704 pots	358 out of 720 pots on 2 lines	313 on 2 lines and 470 on 3 lines	336 out of 400 on 1 line out of 5 lines	343 out of 360
Period of Interruption	7 months	8 months	6 months	4 months	5 months
Pot Reinstatement	2 pots per day	1-2 pots per day	1-2 pots per day	2-4 pots per day	2-3 pots per day
PD (USD)	92 800 000	85 000 000	15 000 000	67 700 000	100 000 000
BI (USD)	150 483 500	140 000 000	28 000 000	74 000 000	150 000 000
Gross Loss (USD)	243 283 500	225 000 000	43 000 000	141 700 000	250 000 000



5.4. Reinstatement Period

The reinstatement period depends on the number of frozen pots and the method used to restart them. After analyzing the different losses, we see that:

- pot recovery per day varies from 1 or less up to 4 pots/day.
- average number of pots damaged is around 350.
- average period of interruption for repairs is around 6 months
- there is an improvement of the insureds' ability to restart pots quickly in the more recent losses.

It is important to keep in mind that all pots are not the same from one loss to another. In the past, frozen pots had to be relined. This is a mechanical process which consists of removing the frozen metal. It requires heavy dismantling of the pots. During this operation, refractories and cathode blocks are likely to be damaged/replaced. The normal cost of pot relines is estimated at approx. \$300,000/pot. This operation can be even more complex if equipment and/or infrastructure was damaged when the loss occurred.

The Crash Start process makes it possible to reduce the period of business interruption with a reduced cost of restarting the pots. There were two recent losses for which:

- 70% were restarted on line (crash start) - cost of cleaning: USD 45K/pot
 - The preheat technique used was a coke resistor, followed by a hot bath transfusion.
 - During the restart, there was also a coke resistor restart with an in-situ bath generation.
 - During cleaning, some of these cells had to be demolished and relined.
- 30% of the pots had to be relined (fully relined: USD 300K/pot or partially relined: USD 90K/ Pot)
- 10% of the "crash start" pots had to be relined due to pot lining damage.

5.5. Pot life reduction after relining

The duration of life of a new pot is around 2000 days.

The amount of life left in a pot is used to determine the value of the pot, the treatment which it should receive (restart or full repair/replacement) and the calculation of the loss of life of the pot when it has to be fully relined.

The Loss of Life (LOL) calculation is a complex subject with no standard terminology other than estimates & guesstimates. The number of days lost or % of life lost takes into account the following factors:

- Type of pot
- Age of the pot lines
- Predicted life and residual life
- Type of event (shutdown, be it economic (long) or outage (short)),
- Length of time in storage
- Restart method
- Cleaning of metal or pot lining, damage during cleaning
- No. /or % of pots failing in early operation (defined days)
- No. (and type) of restart failures until the last pot fails

Using the above factors, the individual or average life at time of failure can be calculated and comparisons can be done on a like-to-like basis.

Some specialized policies may define the average life duration as follows:



POTLINE FREEZE Valuation: In the event of pot line solidification, if the smelting pots can be successfully restarted, it is agreed that the **pot life** is reduced by an amount equal to 20% of the pot replacement value. The pot replacement value shall consist of the average anode cost, average reline cost and spent pot liner cost per line.

In most cases, in case of loss, the life duration must be calculated and agreed upon between Insured and Insurers. The table below shows that the life duration of a pot can be reduced by 100 to 400 days depending on the circumstances of the loss.

Basically, column 1 (LOL of 100/200 days) presents a controlled shutdown in a situation where pots are mostly new and in good shape. Column 2 (LOL of 200/300 days) is a controlled shutdown on an average quality pot. Column 3 presents the worst-case scenario with an uncontrolled shutdown on an aged pot line.

Best-case Scenario



Worst-Case Scenario

Low loss of pot life (100 to 200 days)	Average loss of pot life (200 to 300 days)	High loss in pot life (300 to 400 days)
A low number of premature failures	Normal number of premature failures	high number of premature failures
Low to normal age distribution	normal pot age distribution	high pot age distribution
4 to 12 cm of metal left in pot	minimal cleaning and time left exposed prior to restart	long extended cooling period prior to shutdown
Controlled shutdown	Controlled shutdown	Uncontrolled shutdown
Slow restart practice	improved restart practices	Rapid restart practice
good control of pot temp after restart	control of pot temp after restart	marginal control of temperature after restart

5.6. Additional Costs

After a pot freeze, the insured always faces 3 main types of an increased cost of working:

- **Increased energy usage:** the newly started pots consume more energy than a normally operating pot. Energy is considered a 100% variable cost.
- **Increased carbon consumption due to increased anode usage:** anodes are consumed during the production process and will need to be replaced on a regular basis. However, all anodes cannot be replaced at the same time on an operating pot. So, when a new pot is introduced on the line, its new anodes need to be replaced prematurely in order to achieve a staggered wear pattern across all pot anodes. The prematurely replaced anodes are sent back to the carbon plant for reprocessing.
- **Increased cost of silicon alloying material:** due to the high iron content in the hot metal produced in the newly started pots, some smelters have to use a silicon material of a higher purity than that normally used in the cast house in order to achieve finished metal products compliant with acceptable specifications. This higher purity silicon has a higher purchase price than the silicon grade normally used.



6. LOSS ESTIMATES

Maximum Possible Loss (Technical MPL – SCOR):

Scenario & financial consequences:

Smelter MPL Pot Freeze scenario:

- A major loss at the main smelter substation (e.g. USD 25-65M total value reported): loss of all GIS bay panels installed within the same room which is provided with air sampling detection (VESDA) installed on the common false floor housing cables and protected with sprinklers. All detection and protection systems are out of order for the MPL case. This would lead to Pot Freeze due to the major power outage. As a result, all cells are lost including anodes (no Controlled Shut Down considered for the worst-case scenario). All pots have to be rebuilt (frozen material, damaged cathode, refractories).
- **Note on Pot Freeze Recovery Plan:**
 - Only a conventional restart (so called “Fresh Start”) after delining / relining is considered for the MPL. Other methods such as crash starts, metal starts, cold starts, etc. are not considered (reportedly not suitable for large operations as they require a lot of manpower for material handling, supervision and process parameter adjustment).
- **MPL PD: USD 450k per pot x 100% of the pots.** (For our loss estimates, in order to be sufficiently conservative, we considered the highest costs given in the below table, no controlled shut down, and the loss of all anodes. This would make recovery even more difficult). Thus except when reliable and accurate cost data are available.
- **Extra Costs (5% of MPL PD):** some extra costs need to be considered for restarting the smelter pots.
- **MPL BI: Consider the longest period of time given below:**
 - **At least 17-18 months at 100%** to be considered for the MPL for re-building the pots.
 - **Up to the maximum time needed for rebuilding and restarting all pots** (based on smelter-reported rebuild & restart capacity. e.g. 10-15 per months for either a “Batch after Batch” or an All in One” based re-start sequence).
- **Induced BI** should be considered if there are any interdependencies with sister plants upstream and/or downstream. This could be mitigated by buffer storage (providing some extra days of production) and an alternate supplier (if any).

Notes regarding PD:

- The cost for rebuilding a pot is basically driven by the cost of the cathodes.
- The cathodes based on carbon are made of dry aggregates, usually anthracite, graphite or petroleum coke. These components are sieved, grinded and mixed, following a precise recipe, and bound together with a binder having a high coking value, usually coal tar pitch.
- As a result of the above, a standard cathode is basically made of petroleum products. Consequently, the cost for rebuilding a pot after pot freeze is relatively volatile due to commodity fluctuations (as shown in the table below for some smelters worldwide):

Date of value (visit on site)	Cost of re-building a pot (including pot removal)	Average cost per pot (rounded)
January 2013	between USD 315k and USD 450k	USD 382k
December 2018	between USD 225k and USD 240k	USD 232k
November 2021	between USD 120k and USD 450k	USD 285k

- USD 300k per pot is commonly considered by some brokers and insurers as an average for loss estimates (see PML and also Loss Experience Analysis).



- In some cases reliable and accurate data regarding to cost to rebuild a pot and other related costs is given and can be used for loss estimate (MPL/NLE) calculation (fined tune) as follows (figures given for example):
 - Cost to reline a pot: USD 350k
 - Anode material loss (100% of all anodes per pot for MPL):
 - Number of anodes per pots: 30
 - Cost of 1 anode (in-house production): USD 900 per Anode assembly (baked anode: USD 750 per ton and per anode USD 804, rodded anode USD 840 per ton. Note that one baked anode being 1.072 tons as per this month production data).
 - Bath material loss (100% of the bath – pure & cover - per pot for MPL):
 - Content of bath material in ton per pot: 30 tons of pure bath and 10 tons for cover bath (cover bath is to cover the anodes)
 - Cost of 1 ton of Bath material: pure bath USD 40 pr ton, cover bath USD 5 per ton or zero value depending on market condition

Notes regarding BI:

- The loss amount is mainly BI-driven (see Loss Experience Analysis).
- According to some smelter operators, up to 22-23 months BI is to be expected based on the delining / relining capacity (deemed as a bottleneck).
- The restart of the pot line may be first subject to reinstatement of a facility responsible for the power outage:
 - Tsunami severely damaging the captive power plant built on the seashore as well as the national grid providing partial back up: up to 18 months reinstatement.
 - Fire in the GIS building of the main substation (GIS bays): 8-12 months reinstatement.
 - Fire in the main grid substation: 6 months reinstatement
- The restart of the pot may be also delayed by procurement issues (figures given for example):
 - About 25 pots are de-lined (3 days per pot) and relined and restarted within the next 50 days (#15 per month = 0.5 per day lining capacity) after the power outage using the stock of Raw Material on site (cathodes and refractories available on site equivalent to 25 pots reportedly).
 - Lead time for cathodes (from order to delivery – standard and current considering supply chain issues due to covid and market demand): 5- 6 months during normal condition and up to 9 months during pandemic and considering the type of cathodes.
 - Lead time for pot refractories (from order to delivery standard and current considering supply chain issues due to covid and market demand): 3-5 months. Note that refractory brick may be stored on site for 2 years. Mortar cannot be kept on site more than 6 months (expiry date and temperature / moisture control needed).
- **Induced BI** should be considered if there are any interdependencies with sister plants upstream and/or downstream. This should be investigated and cross-checked with the different sister plants.
- See example below.

For example: 720 pots to be rebuilt:

- **Based on the delining capacity (considered as a bottleneck):** 1 bay, 21 pot cells / month #34 months recovery (This is using internal capacity equipped with a dust removal system as per regulations – no outside solution foreseen).
- Relining capacity: 5 bays, 25 pot cells / month #29 months recovery. Note: equivalent of 10 pots cells of refractory is available on site. The refractory supply for relining needs to be organized.



- BI Smelter: 4 reinstatement phases considering normal conditions and a gradual mode for restart (“All at Once” within cross- over feeding areas) corresponding to #21.25 months at 100% as detailed below:
- 8.5 months at 100% BI before restarting 50% of pot line 1 (cross-over installed)
- 8.5 months at 75% BI before restarting 100% of pot line 1 (cross-over removed)
- 8.5 months at 50% BI before restarting 50% of pot line 2 (cross-over installed) while pot line 1 is fully operating
- 8.5 months at 25% BI before restarting 100% of pot line 2 (cross-over removed) while pot line 1 is fully operating
- The process units upstream and downstream will also be impacted (6 months for reinstating the substation):
- BI impact on the upstream and downstream process units (respectively the Refinery and the Rolling Mill:
 - During the first 6-month period of reinstatement of the substation: #6 months BI at 100% due to the lack of electric power
 - During the 2,5 following months (all pot lines still shut down):
 - BI impact on the upstream unit (Refinery) selling alumina to other smelters: #loss of added value # 30% BI loss.
 - And
 - BI Impact on Rolling Mill purchasing and processing (adjustment / loss of efficiency) slabs on the market: #extra cost #30% BI loss
 - During the 8,5 following months (pot line 1 operating at 50%):
 - BI impact on the upstream unit (Refinery) selling alumina to other smelters: #loss of added value # 23% BI loss
 - and
 - BI Impact on Rolling Mill and (Automotive) Sheeter purchasing and processing (adjustment / loss of efficiency) slabs on the market: #extra cost # 23% BI loss
 - During the 8,5 following months (pot line 1 operating at 100%):
 - BI impact on the upstream unit (Refinery) selling alumina to other smelters: #loss of added value # 18% BI loss
 - And
 - BI Impact on Rolling Mill purchasing and processing (adjustment / loss of efficiency) slabs on the market: #extra cost # 18% BI loss
 - During the 8,5 following months (pot line 1 operating at 100% and pot line 2 operating at 50%):
 - BI impact on the upstream unit (Refinery) selling alumina to other smelters: #loss of added value # 10% BI loss
 - And
 - BI Impact on Rolling Mill purchasing and processing (adjustment / loss of efficiency) slabs on the market: #extra cost # 10% BI loss

Carbon Plant MPL Fire scenario:

- Major fire in a Paste Plant. (The paste plant deals with combustible material with the highest fire potential).
- **MPL PD:** total loss of the Paste Plant.
- **MPL BI:** 24 months at 100% for the Smelter, based on the following:
 - 24 months needed for the reinstatement of the Paste Plant, during which time there is no anode production



- No consideration for existing anode inventory (usually 20-30 days' supply)
- No anode alternate supply considered for the MPL
- As a result, the Reduction Plant would stop due to the lack of anodes (no mitigation measures considered).
- And, if the Reduction Plant is shut down, the Cast House will also have to shut down due to the lack of hot metal produced at the Reduction Plant.
- **Extra Costs:**
 - Some extra costs need to be considered for the Carbon Plant (e.g. debris removal, cleaning), estimated at 15% of Carbon Plant PD.
 - The reduction of life expectancy (aging) of some pots, due to shut down, should be considered (the oldest pots may have to be rebuilt). As a rule of thumb, consider that 10% of the pots will have to be rebuilt.
- **Induced BI** should be considered if there are any interdependencies with sister plants upstream and/or downstream. This could be mitigated by buffer storage (providing some extra days of production) and an alternate supplier (if any). See example below:
 - BI impact on the upstream unit (refinery) selling alumina to other smelters (#loss of added value # 30% BI loss for 24 months)
 - BI Impact on the Rolling Mill purchasing and processing (adjustment / loss of efficiency) slabs on the market (#extra cost #30% BI loss for 24 months)
- **Note:**
 - Carbon Plant operators usually consider between 21 and 24 months (with a minimum of 18 months) to be necessary for rebuilding their Paste Plant.

Probable Maximum Loss (Market definition):

Note that in terms of loss estimates at SCOR, only MPL and NLE are considered. There is no leeway for using any other acronym or definition (i.e. EML, PML, etc.). EML or PML are only given for information.

Smelter PML Pot Freeze scenario:

- Same scenario as for the MPL but with different consequences depending on the level of preparedness. A Reliable Controlled Shut Down (if any) may allow the saving of 50% of the pots as calculated below. When there is no reliable CSD, please refer to the MPL above.
- **Note on Pot Freeze Recovery Plan:**
 - A conventional restart after delining / relining as well as other methods such as crash starts, metal starts, cold starts, etc. can be considered. The results of non-conventional recovery attempts cannot be known in advance. It would depend on the reliability of the Recovery Plan for a given technology that allows for non-conventional restarts. The experience and preparation of the smelter for using such non-conventional restarts is key. As a result, several pots may have to be relined or totally replaced (50% considered for the PML).
- **PML PD: USD 300k per pot x 50% of the pots.**
- **Extra Costs (5% of PML PD):** some extra costs need to be considered for restarting the smelter pots.
- **PML BI: Consider the longest period of time given below:**
 - **At least 11 months at 100%** to be considered for the PML for re-building the pots.
 - **Up to the maximum time needed for rebuilding and restarting all pots** (This would be based on reported smelter rebuild & restart capacity. e.g. 10-15 per month on either a "Batch after Batch" or an "All in One" restart sequence). This should be based on a reliable Recovery Plan.



- **Induced BI** should be considered if there are any interdependencies with sister plants upstream and/or downstream. This could be mitigated by buffer storage (providing some extra days of production) and an alternate supplier (if any).

Carbon Plant PML HTM Boiler Explosion & Fire (Paste Plant) scenario:

- Paste Plant: explosion and fire involving the HTM boiler(s) (e.g. 2 boilers for two lines but in the same room). The boiler is located in a detached building made of Damage-Limiting Construction.
- **PML PD: estimated at 15% of the paste plant assets.** (total loss of the HTM boiler(s) resulting in shut down of the paste plant).
- **PML BI:** at least 7 months at 100% for the Smelter, based on the following:
 - 8 months needed for the reinstatement of the Paste Plant, during which time there is no anode production.
 - Existing anode inventory must be considered (usually 20-30 days' supply # 1 month).
 - No anode alternate supply considered for the PML.
 - As a result, the Reduction Plant would stop about 1 month after the event due to the lack of anodes (no mitigation measures considered).
 - Furthermore, as the Reduction Plant is shut down, the Cast House will also have to shut down due to the lack of hot metal produced at the Reduction Plant.
- **Extra Costs:**
 - Some extra costs need to be considered for the Carbon Plant (e.g. debris removal, cleaning) estimated at 15% of Carbon Plant PD.
 - The reduction of life expectancy (aging) of some pots, due to shut down, should be considered (the oldest pots may have to be rebuilt). As a rule of thumb, consider that 10% of the pots will have to be rebuilt.
- **Induced BI** should be considered if there are any interdependencies with sister plants upstream and/or downstream. This could be mitigated by buffer storage (providing some extra days of production) and an alternate supplier (if any). See example below:
 - BI impact on the upstream unit (Refinery) selling alumina to other smelters (#loss of added value # 30% BI loss for 20 months).
 - BI impact on Rolling Mill purchasing and processing (adjustment / loss of efficiency) slabs on the market (#extra cost #30% BI loss for 20 months).

Notes:

If there is an adequate, formalized and tested Contingency Plan for the supply of anodes (see section 4.3), there would be no BI for the Smelter and therefore no induced BI for the PML scenario.

Carbon Plant PML Fire scenario:

- A fire starts in the upper levels of the Paste Plant in the HTM expansion tank.
- Sprinkler protection is provided at all levels of the Paste Plant structure.
- One sprinkler is impaired (or problem of faulty design: the sprinklers above the expansion tanks are in excess of 10 m from the tank and there are obstructions in between, including grated and solid steel platforms. This results in a delay in their activation, allowing the fire to spread to a majority of the levels where the expansion tanks are located).
- There is some loss of HTM oil. The fire spreads to the level below and this activates sprinklers at that level. The on-site fire team is alerted by fire alarms and operators, and they control and extinguish the fire with the assistance of the sprinklers.
- There is damage to the affected level of the Paste Plant, plus some fire damage to the level below, as well as smoke and water damage.



- **PML PD:** estimated at 15% of the Paste Plant assets.
- **PML BI:** at least 3 months at 100% for the Smelter, based on the following:
 - 4 months needed for the reinstatement of the Paste Plant, during which time there is no anode production.
 - Existing anode inventory must be considered (usually 20-30 days' supply # 1 month).
 - No anode alternate supply considered for the MPL.
 - As a result, the Reduction Plant would stop about 1 month after the event due to the lack of anodes (no mitigation measures considered).
 - Furthermore, as the Reduction Plant is shut down, the Cast House will also have to shut down due to the lack of hot metal produced at the Reduction Plant.
- **Extra Costs:**
 - Some extra costs need to be considered for the Carbon Plant (e.g. debris removal, cleaning) easily amounting to 15% of Carbon Plant PD.
 - The reduction of life expectancy (aging) for some pots, due to shut down, should be considered (the oldest pots may have to be rebuilt). As a rule of thumb, consider that 10% of the pots will have to be rebuilt.
- **Induced BI** should be considered if there are any interdependencies with sister plants upstream and/or downstream. This could be mitigated by buffer storage (providing some extra days of production) and an alternate supplier (if any). See example below:
 - BI impact on the upstream unit (refinery) selling alumina to other smelters (#loss of added value # 30% BI loss for 20 months).
 - BI Impact on Rolling Mill purchasing and processing (adjustment / loss of efficiency) slabs on the market (#extra cost #30% BI loss for 20 months)
 - Notes:
 - If there is an adequate, formalized and tested Contingency Plan for the supply of anodes (see section 4.3), there would be no BI for the smelter and therefore no induced BI for the PML scenario.

Estimated Maximum Loss (Market definition):

Note that in terms of loss estimates at SCOR, only MPL and NLE are considered. There is no leeway for using any other acronym or definition (i.e. EML, PML, etc.). EML or PML are only given for information.

Smelter EML Pot Freeze scenario:

- Fire in the GIS cable vault destroying all cables and damaging the GIS equipment of a pot line.
- Depending on the level of preparedness, we will say that it is possible to save 75% of the pots, calculated for a pot line housing 800 pots (for example). It is estimated that 25% of the pots will require a complete rebuild and relining, and the remaining pots will suffer a 10% loss of life due to the cold start (200 hours out of 1800 hours life expectancy). The cost to rebuild the pots is estimated at USD 230k per pot. There is also the loss of anodes and bath material inside the pots. The anode material loss in each pot is estimated at 70% with 40 anodes/pot, and an in-house anode production cost of USD 600/anode. Bath material loss is estimated as 16 ton/pot at a cost of USD 400/ton.
- **EML PD: USD 258.36Mio** as detailed below:
 - PD to GIS equipment and cable vault: USD 180Mio
 - +
 - Pot line PD damages= USD 78.36Mio as detailed below:
 - Cost to re-line pots = 25% x 800 pots x USD 230k = USD 46Mio
 - Pot damage from loss of life = 75% x 800 pots x 10% x USD 230k = USD 13.8Mio



- Anode material loss = 70% x 40 anodes x 800 pots x USD 600 = USD 13.44Mio
- Bath material loss = 16 x 800 pots x USD 400 = USD 5.12Mio
- **EML BI:** Total gross profit loss is USD 929Mio as detailed below:
 - Reinstatement of the cable vault and GIS equipment is estimated at 12 months, followed by 3-month pot ramp-up period at a restart rate of 10 pots per day (based on smelter capacity). So, the total outage is 15 months.
 - Breakout and rebuild of pots can be done during the substation reinstatement period at a rate of one pot per day.
 - Gross profit/margin per ton of molten metal is estimated at USD 850/ton.
 - Average production per month of molten metal production is about 80kton.
 - Total gross profit loss at USD 850/ton is USD 816Mio over 12 months of power outage.
 - Pots are restarted at a rate of 10 pots per day during the 3-month ramp-up period and the corresponding gross profit loss is about USD 79Mio.
- **Induced BI** should be considered if there are any interdependencies with sister plants upstream and/or downstream. This could be mitigated by buffer storage (providing some extra days of production) and an alternate supplier (if any).

Normal Loss Expectancy (NLE – SCOR):

Smelter NLE Pot Freeze scenario:

- Same scenario as for the MPL and PML but with different consequences depending on the level of preparedness. A Reliable Controlled Shut Down (if any) may allow the saving of 75% of the pots as calculated below. When there is no reliable CSD, please refer to MPL/PML above.
- **Note on Pot Freeze Recovery Plan:**
 - A conventional restart after delining / relining (so called “Fresh Start”) as well as other methods such as crash starts, metal starts, cold starts, etc. can be considered. The results of non-conventional recovery attempts cannot be known in advance. It would depend on the reliability of the Recovery Plan for a given technology that allows for non-conventional restarts. The experience and preparation of the smelter for using such non-conventional restarts is key. As a result, several pots may have to be relined or totally replaced (25% considered for the NLE).
- **NLE PD: USD 450k per pot x 25% of the pots.** (For our loss estimates, in order to be sufficiently conservative, we considered the highest costs given in the above table). Thus except when reliable and accurate data are available as follows (figures given for example):
 - Cost to reline a pot: USD 350k
 - Anode material loss (67-70% of all anodes per pot for NLE):
 - Number of anodes per pots: 30
 - Cost of 1 anode (in-house production): USD 900 per Anode assembly (baked anode: USD 750 per ton and per anode USD 804, rodded anode USD 840 per ton. Note that one baked anode being 1.072 tons as per this month production data).
 - Bath material loss (About 10 tons of pure bath per pot for NLE):
 - Content of bath material in ton per pot: 30 tons of pure bath and 10 tons for cover bath (cover bath is to cover the anodes)
 - Cost of 1 ton of Bath material: pure bath USD 40 per ton, cover bath USD 5 per ton or zero value depending on market condition.
 - Loss of life for restarted pots due to cold start: around 11% of the cost to reline a pot multiplied by the number of restarted pots.
- **Extra Costs (5% of MPL PD):** some extra costs need to be considered for restarting the smelter pots.



- **NLE BI: Consider the longest period of time given below:**
 - **At least 6 months at 100%** to be considered for the NLE for re-building the pots.
 - **Up to the maximum time needed for rebuilding and restarting all pots** (This would be based on reported smelter rebuild & restart capacity. e.g. 10-15 per month on either a “Batch after Batch” or an “All in One” restart sequence). This should be based on a reliable Recovery Plan.
- **Induced BI** should be considered if there are any interdependencies with sister plants upstream and/or downstream. This could be mitigated by buffer storage (providing some extra days of production) and an alternate supplier (if any).
- Note:
 - This scenario is only valid when there is a formalized and tested Contingency Plan (CP) including Controlled Shut Down and Pot Freeze Strategy Recovery.

Carbon Plant NLE Fire scenario:

- A fire starts in the upper levels of the Paste Plant in the HTM expansion tank.
- Sprinkler protection is provided to all levels of the Paste Plant structure.
- Sprinkler protection is activated and controls the fire until it is finally extinguished by the fire fighters.
- **NLE PD:** an area equivalent to the sprinkler design area or surface of application (e.g. 280 m², 370 m² or more depending on design) of the Paste Plant content is damaged.
- **Extra Costs:**
 - Some extra costs need to be considered for the Carbon Plant (e.g. debris removal, cleaning), estimated at 15% of Carbon Plant PD.
- **NLE BI:** None. 1-2 weeks up to 1 month maximum for reinstatement.
 - In the mean-time there is no anode production.
 - However, the existing anode inventory (usually 20-30 days' supply # 1 month) will provide adequate supply.
- Extra Costs: None.
- Induced BI: None.
- Note:
 - This scenario is only valid when an adequate and reliable sprinkler protection is installed. In case of design issues, please consider the PML scenario above.



VI - ALUMINUM ROLLING MILL FOCUS

1. PROCESS

Rolling Mills are used to:

- Transform large and thick cast slabs/plates and subsequent intermediate products of aluminum alloys by squeezing the incoming material between two horizontal rolls to produce a longer and thinner product.

And

- Provide the desired surface finishes and mechanical properties.

Rolling Mill types:

- Various types of mills are used in the aluminum industry. There are two main categories:
 - Hot Mills handle reheated cast ingots and subsequent hot intermediate strips and are generally used to reduce the thickness of a material from several inches or centimeters to a few tenths of an inch or millimeters.
 - Cold Mills handle cold plates or coiled strips coming from hot mills (or continuous casters) and are generally used to further reduce the thickness to a few mils (tenths of a millimeter), and even further (down to a fifth of a mil [0.005 mm]) in the case of Foil Mills.
- Rolling Mills may also be categorized in accordance to:
 - Metal travel direction - reversible or nonreversible: In a reversible mill, rolling is done alternately in opposite directions, and thickness is reduced while the metal travels in each direction.
 - The number of rolls or the number of rolling stands.
 - How the rolls move vertically, as well as how pressure is exerted on the rolls (mechanically or hydraulically).
 - From a fire hazard standpoint: the type of hydraulic fluid and the type of rolling fluid (coolant/lubricant) used.

Rolling Mill - Glossary of Terms:

- **Continuous Mill:** The product only passes once through the mill.
- **Edging Mill:** The edging mill (or edger) shapes the sides of the slab or rolled product, often using two vertical rolls. The edger rolls and sizes the side face of the slab and breaks loose scale from the edges.
- **Finishing Mill:** Takes the rough shape and turns it into a finished hot-rolled product. This product can either leave the plant at this stage or continue to be further reduced using cold rolling processes. Many different finishing operations can be performed on the product prior to delivery to the end users. Finishing operations may include heat treatments, size-changing operations such as slitting and cutting, metallurgical treatment such as tension levelling and stretching, and surface finishing, including various types of coatings. All these finishing operations can be performed on continuous equipment.
 - Flat products may be cut to desired dimensions. Coiled strip width may be adjusted to needs with slitting shears. Stretchers are used to homogenize stress and align fibers of flat products (see Data Sheet 13-8). Similarly, coiled products may be tension-levelled by uncoiling and recoiling under tension (to improve the flatness of the strip).
 - Surface finishing includes washing and degreasing operations, varnishing, painting, lacquering operations, oil coating (prior to rework on punching or stamping presses), and anodizing.
 - Surface finishing also includes the use of specialized rolling mills for a bright finish or special embossed profiles.



- Several layers of different alloys, metals, or combinations of metals and non-metallic materials may be laminated together on a rolling mill to manufacture a layered composite material. An example would be an inner material of high strength, but low resistance to corrosion, protected by two outer layers of lower strength but higher resistance to corrosion.
- **Foil Mills:** Foil mills are cold mills that specialize in producing very thin products. These mills are usually smaller than other cold mills (see Fig. 44). Incoming material thickness ranges from 0.5 to 0.6 mm (20 to 24 mils). Final product thickness ranges from 0.15 mm (6 mils) to as low as 0.005 mm (a fifth of a mil). The thickness reduction process is usually done by several mills in series. The maximum strip width is approximately 2 m. (80 in). To produce the thinnest foil, two layers of metal are rolled together in a process called doubling. Foil doubling can be on the mill itself (two un-coiler stations) or on separate foil doubling machines. Foil separation is usually performed on separate machines. Foil Mills use only petroleum-based cooling/rolling fluids.
- **Heat treatment:** During cold rolling, the metal loses ductility, and annealing is often necessary between successive rolling operations. Also, depending on the end use and required characteristics, it may be necessary to subject the metal to various heat treatments, including solution heat treatment followed by water quenching, precipitation treatment, and annealing. Heat treatment may be done in batch-type or continuous-type furnaces, under normal or special atmospheres.
- **Ignitable liquid supply:** Tanks/reservoirs, pumps, filtration and ancillary equipment supporting use-point(s), in this case on the mill, typically containing much more fluid hold-up capacity than the use point(s). Supplies can range in volumetric size from tens of gallons to thousands of gallons of fluid.
- **Mill stand:** A section of the mill housing set(s) of rolls.
- **Plate Mill:** These mills produce plate products. Plate mills can be either universal mills or sheared plate mills (discreet or individual plates).
- **Primary Mill:** A mill that handles ingots only.
- **Reversing Mill:** The product is passed back and forth through the same mill. Reversing mills can be used to work slabs, heavy plate, or finished products.
- **Roughing Mill:** The first operation in the hot milling process. The roughing mill (or rougher) takes the ingot or cast product and further reduces it into the “rough” shape of the product via vertical force. These mills are usually reversing mills.
- **Sendzimir Mill (Z-Mill):** A cold rolling mill used in the processing of specialty metals such as stainless steel, silicon steel, titanium, zirconium and beryllium.
- **Steckel Mill:** Uses two coils of sheet steel to feed the sheet back and forth through the mill, rather than driving it through with the rollers. If a Steckel Mill is being used in hot rolling, a furnace is located at each end to help maintain the steel at the desired temperature. There are no furnaces present if the Steckel Mill is being used for cold rolling. Steckel mills are commonly used for stainless or acid-resistant grade steel, nickel and cobalt alloys, or titanium alloys.
- **Strip mill:** Produces hot-rolled sheet. (Typical from 1970s). In general, these mills consist of a reversing rougher and multiple-finishing mill stands. Upon exiting the last finishing mill stand, the sheet is wound into coils. A Strip Mill can also be arranged so the metal passes only one way through the mill. If this arrangement is being used there are normally multiple stands arranged far apart for the metal to pass through.



Process flow chart: depending on final products, Rolling Mills can be arranged in different ways:

Example of Automotive Sheet line and Can line

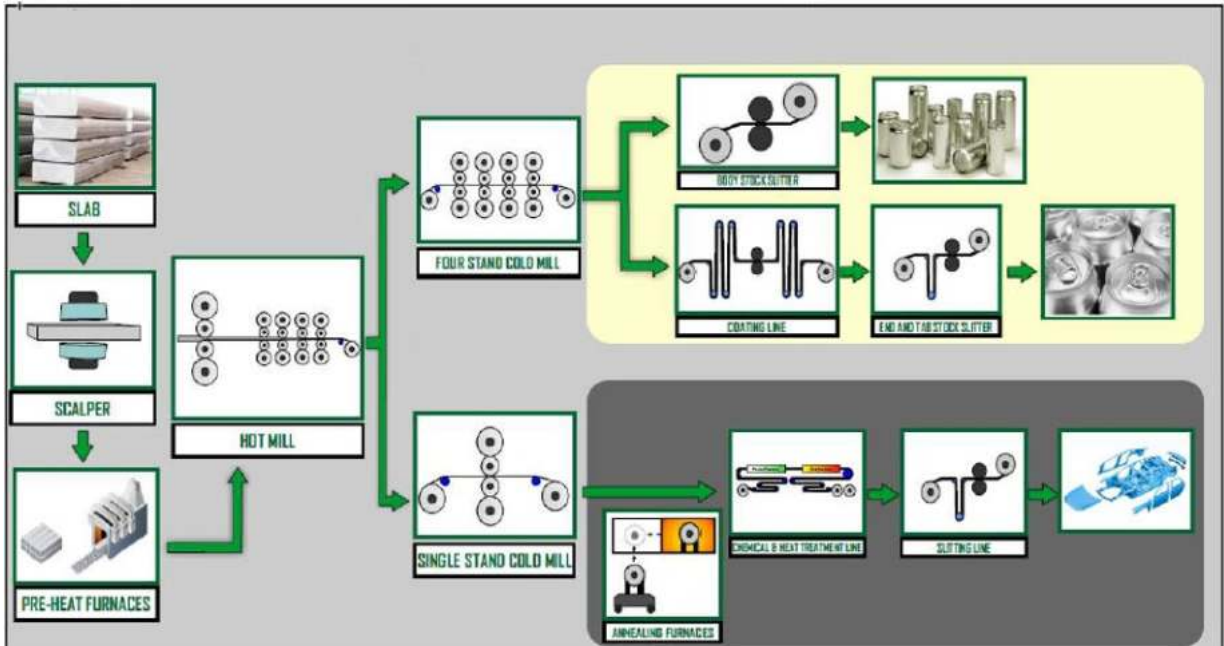

Courtesy of Virtual i Technologies Ltd, Risk Engineering Service Provider for Aon in the Middle East

Can line details

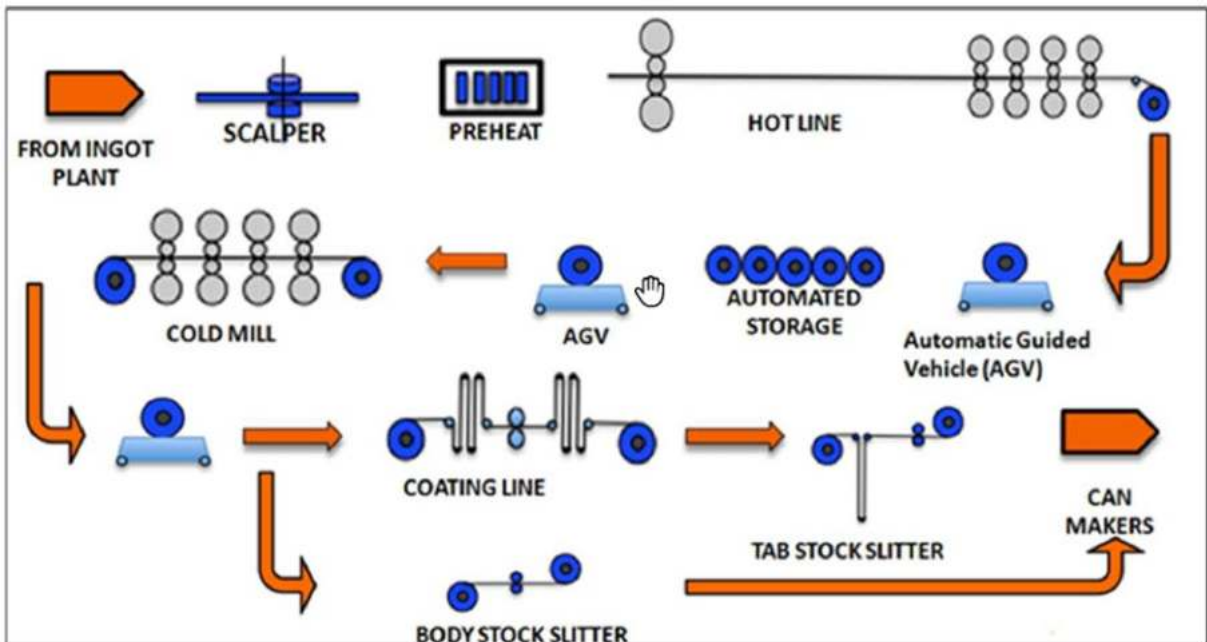

Courtesy of Virtual i Technologies Ltd, Risk Engineering Service Provider for Aon in the Middle East



Automotive Sheet line details

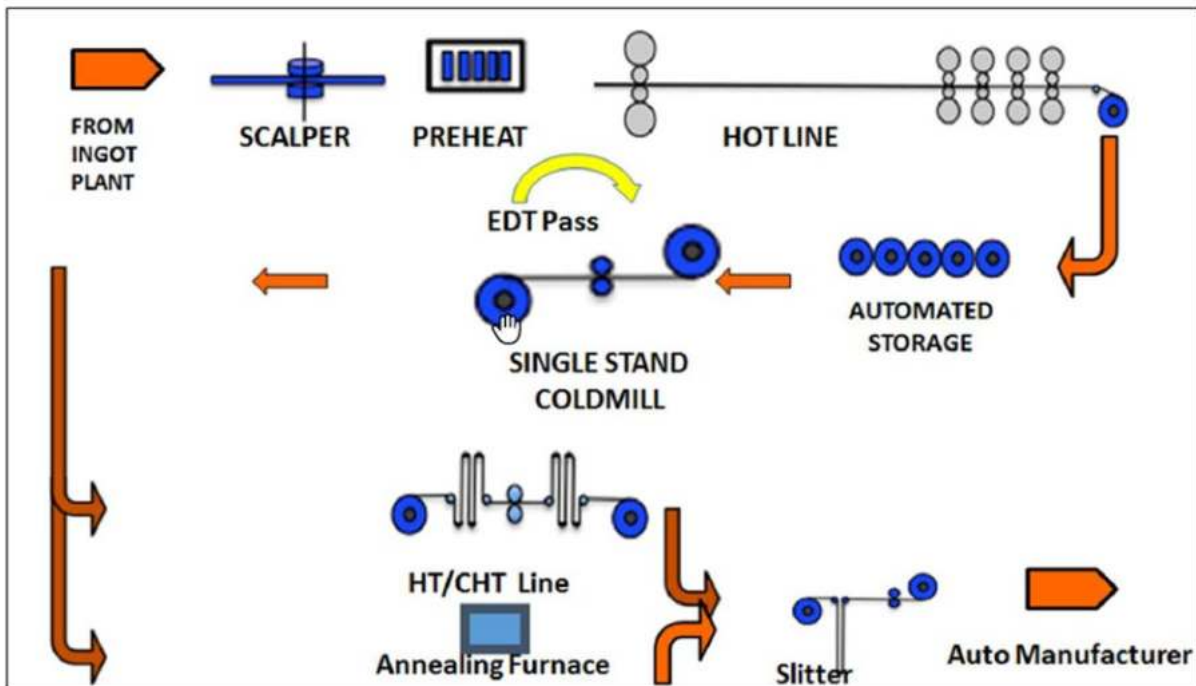

Courtesy of Virtual i Technologies Ltd, Risk Engineering Service Provider for Aon in the Middle East

- The above includes the following equipment (characteristics given as example):
 - **Scalper:** The top surface is scalped, returned to the turnover device, then scalped on the other side. Some slabs not requiring scalping are loaded directly into the Preheat Furnace
 - **Preheat Furnaces:** pusher-type furnaces provided with roof-mounted burners. The furnaces operate in batches and can load a maximum of 30 ingots. The cycle time is 15-20 hours maximum; charge temperature is 610°C and the soak temperature range is from 450° to 610°C
 - **Hot Reversing Mill (HRM):** a roughing stand using 2 x 4.5 MW ac motors. Both rolls are independently driven via separate gearboxes. A 4-high (4-Hi type) reversing mill reduces the slab thickness, in multiple passes (depending on the product), from the scalped thickness to the transfer bar thickness of approximately 30 mm. The strip is then passed through heavy and light crop shears. The operation is based on 20-23 passes. The HRM is a Type 2 mill as per FM classification using oil (4%) in water (96%) emulsion as rolling fluid, and mineral oil as hydraulic fluid.
 - **Hot Continuous Mill (HCM):** A 4-stand 4-high continuous mill that reduces the sheet thickness from 30 mm to between 7 mm and 2 mm (depending on the desired thickness for either the Automotive Sheet Line or Can Line). The HCM can be a Type 2 mill as per FM classification using oil (4%) in water (96%) emulsion as rolling fluid, and mineral oil as hydraulic fluid. Stands 1-3 are each driven by a 5 MW ac motor via a gearbox, and the 4th stand is driven by a 7 MW motor via a gearbox (SMS Siemag). The coils are passed to the Automatic Storage Racking System (ASRS) for storage and natural cooling (320°C to 40°C), prior to further processing in either the Can Line or Automotive Sheet Line.
 - **Can Line:** After passing through the HCM, the sheets are passed through the Tandem Cold Mill (TCM) which is a 4-stand 4-high mill where the sheet thickness is reduced by up to 90%. The mill is capable of handling strip widths between 1050 and 2100 mm. For each stand, work rolls are driven by an AC variable frequency motor (No.1, 2 and 3 are rated at 5 MW and No.4 is rated at 7 MW) with stands 1, 2 and 4 driving through a double output gear reducing pinion and drive spindles. Kerosene-based coolant is used as the rolling fluid and mineral oil as hydraulic fluid (Type 3 mill as per FM classification). The mill has a design speed of 1500 m/min.



- **Automotive Sheet Line:** In the Automotive Sheet Line, the sheets are passed through a single stand, single pass Cold Mill that reduces the thickness to between 1.8-1.2 mm. The mill rolling fluid is a kerosene-based coolant (Type 3). The mill is driven by a single motor via a gearbox, which in turn drives two work roll shafts. From there, the sheets are passed to 8 x single coil-annealing furnaces, operating at 300°C with natural cooling. Each furnace has a single natural gas-fired burner and is bottom-loaded. The sheets are then passed through a heat treatment line (multiple levels) and then to slitters (Pit Slitters). A texturing machine that provides texture to the sheets before they are passed through the Cold Mill is provided but has not been used due to lack of customer demand.
- **Finishing:** Finishing capacity is 80,000 mtpa for coating and 300,000 mtpa for slitting. The High-Speed Slitter is used for uncoated Can body stock and Pit Slitters are used for coated Can ends and Auto sheets (the Pit Slitter for Auto sheets is of a heavier gauge). Can ends and tabs are coated at the coating line. Coating is in two stages – initial chrome coating in a two-zone curing oven operating at 220°C, and final epoxy coating in an eight-zone curing oven operating at 230-240°C. The coating line is capable of processing material ranging from 0.15-0.50 mm thick by 1050-1800 mm wide. Can body stock is not coated and the coils are slitted to customer specifications on a High-Speed Slitter (HSS) designed for 1800 m/min. A separate slitter (Pit Slitter) is used for Can ends after they are coated.
- Example of hot rolled products for Engineering & Construction, Circles for cooking equipment manufacturers (food grade) and Cold Mills for foils for packaging products (food grade) manufacturers:

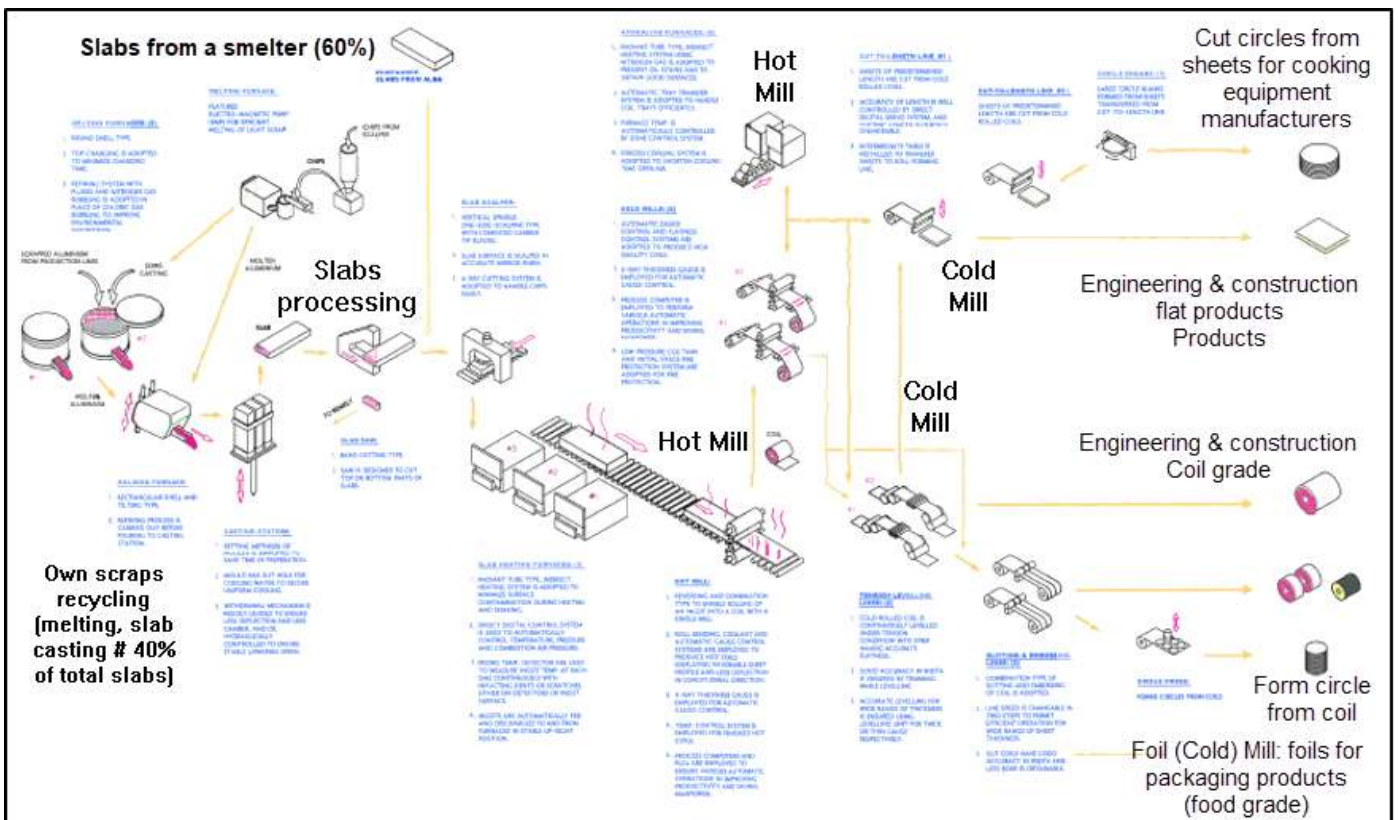

Courtesy of GARMCO - Gulf Aluminium Rolling Mill Co

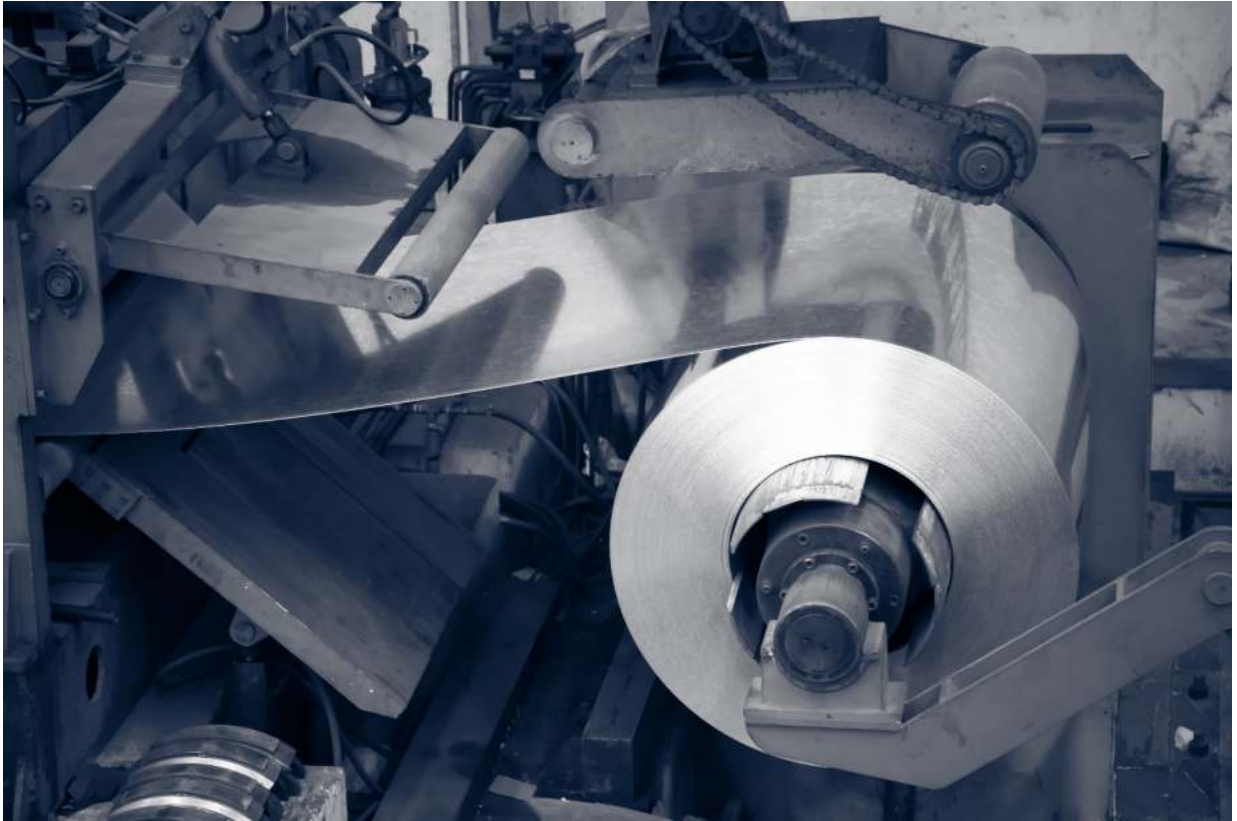

Food Packaging Product

- Note that space and aircraft grade products have distinct characteristics and require special treatment.



2. SPECIAL HAZARDS & RISK CONTROL

Special hazards, prevention, protection and potential mitigation measures are detailed below for each and every special hazard related to this occupancy (following the process flow from Raw Materials to Finished Products as much as possible). Related recommendations are also mentioned “(see. Rec)”. Please refer to section 11. “Support for Loss Prevention Recommendations” for details.

2.1. Construction

- Rolling Mill buildings may include plastic-based material such as sandwich panels with plastic insulation (i.e. PIR, PUR, EPS)

Prevention & Protection:

- Construct buildings or rooms containing a rolling mill and associated equipment using noncombustible building construction materials.
- If combustible or plastic building materials are required, use FM-approved materials. Combustible building construction materials may include: insulated metal panels, insulated steel deck roof assemblies and interior plastic facings. Install FM-approved building materials in accordance with the manufacturer’s guidelines and their FM-approval listing.
- EPS insulated panels should not be permitted on the ceiling as there is no suitable fire protection system for such material installed on the ceiling.
- Where combustible type insulation material is used, appropriate **loss prevention practices** and strict **control of installation and use** of sandwich panels should be established & implemented.

2.2. Fire Hazards

- Fire hazards include:
 - Ignitable liquids and combustible deposits or residues originating from oil spills or leaks, and rolling fluid spray accumulating on equipment, in ventilation systems, or on interior building surfaces
 - High-pressure hydraulic fluid for various functions
 - Spray ignitable rolling fluid on work surfaces for lubrication and cooling
 - Lubricating oil for roll bearings
 - Pool fire
 - Intense thermal exposure by an ignitable liquid hazard resulting in severe damage to power cabling, control wiring, instrumentation and motors.
 - Electrical or control equipment rooms that may constitute a more severe exposure than in other occupancies

Prevention & Protection:

- Many fires involving rolling mills have occurred during maintenance operations. During such operations, local gaseous extinguishing systems may be taken out of service due to life safety concerns. Ignition sources may be present, such as hot work. A very strictly enforced, well defined Hot Work Permit is needed to help minimize such hazards.
- Despite all precautions taken prior to authorizing such work, it should be recognized that it is extremely difficult to ensure complete cleaning of deposits in some areas that can be reached by hot metal particles, thus the so called primary mill protection (see below) should remain in service.
- Ignition of residue or deposits on equipment, in ventilation systems or on interior building surfaces can lead to a fast fire spread, with the potential to out-run ceiling-level automatic sprinklers and increase the likelihood of igniting more substantial secondary fuel packages capable of overpowering fire protection systems. Source control, via exhaust



ventilation and housekeeping, remains the primary safeguard to limit the release of combustibles and monitor and remove buildup.

- As a result of the above, the necessary fire protection for a mill depends on the fire hazards present and the physical arrangement of the mill, as follows (see FM Global Data Sheets 7-21 Rolling Mill):
 - Note: as far as rolling mills are concerned, there are two classes of active fire protection systems: primary and supplementary (as described and shown below) Primary protection is water-based (e.g., ceiling-level / building-level / “high-level” sprinkler or mill-level / “equipment-level” / “low-level” deluge system).
 - Supplementary protection may be a fire extinguishing system using a gaseous suppression agent (e.g., local application carbon dioxide system).
 - This terminology differs from that used in commercial and industrial risks: gaseous extinguishing systems are usually called “primary” due to greater frequency of use, and water-based protection systems are viewed as “backup”-activated in case the primary system fails.

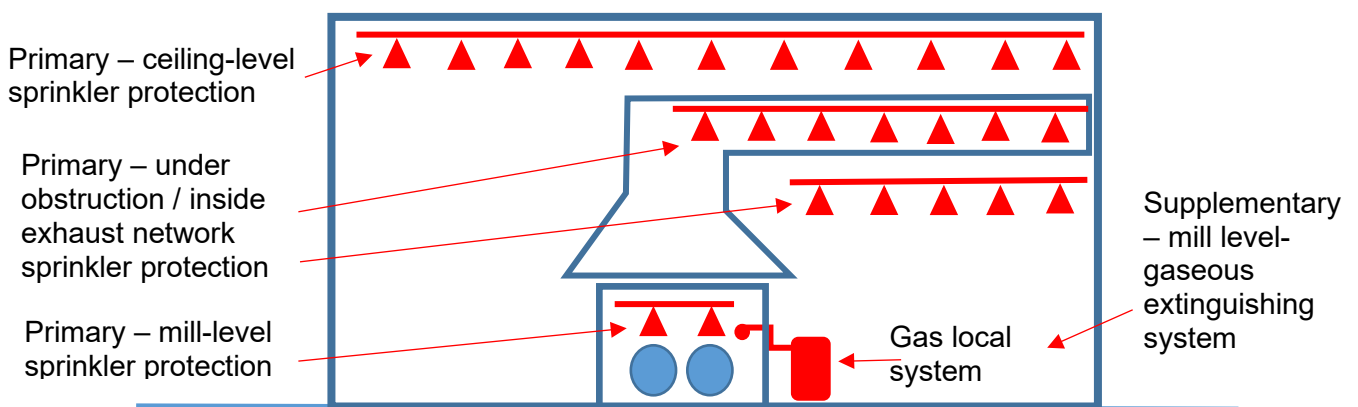

Diagram: © Didier Schütz - DLS

- The industry classifies mills based on the properties of the fluids used in rolling fluids and hydraulic systems. The following are the mill classifications.
 - **Type 1:** Rolling Mills using oil-in-water emulsion rolling fluid (i.e., non-ignitable rolling fluid), and either an FM-approved industrial fluid, non-ignitable hydraulic fluid, or no hydraulic systems present.
 - **Type 2:** Rolling Mills using oil-in-water emulsion rolling fluid (i.e., non-ignitable rolling fluid), and an ignitable hydraulic fluid (e.g., mineral oil).
 - **Type 3:** Rolling Mills using a petroleum-based ignitable rolling fluid (i.e., high or low flashpoint) regardless of hydraulic fluid present.
- **Fire Protection** as per FM Global Data Sheets 7-21 Rolling Mill ed. Jan. 2019:
 - At Open Mills (neither hood nor enclosure), draft curtains installed around rolling mills are intended to limit the ceiling area containing combustible deposits/residues but not limit sprinkler operations. If the mill uses an ignitable rolling fluid (i.e. Type 3), the mills are often fully or partially enclosed by a hood with exhaust ventilation to control flammable mist and vapor.
 - When the mill is fully-enclosed or partially-enclosed by an exhaust hood, provide ceiling-level protection outside the enclosure based on the fire hazards present, the surrounding occupancy and building construction materials, and provide mill level protection.
 - When the mill does not have an exhaust ventilation system with hood (usually Type 1, 2) provide ceiling-level protection only within the draft curtained area above the mill.



- **Ceiling level protection design:**

- **Type 1 Mill** (i.e. combustible loading limited to lubrication fluid and combustible deposits/residues): Design ceiling-level protection in accordance with Data Sheet 3-26, Fire Protection Water Demand for Nonstorage Sprinklered Properties, for an HC-2 occupancy:

US Units								
Ceiling Height	up to 30 ft		30-45 ft		45-60 ft		60-100 ft	
Type Of Sprinkler	Wet	Dry	Wet	Dry	Wet	Dry	Wet	Dry
Density (gpm/ft ²)	0.2	0.2	0.2	0.2	0.2	0.2	0.6	NA
Area of demand (ft ²)	2500	3500	2500	3500	2500	3500	1200	NA
Hose Demand (gpm)	250							
Duration (min)	60							

SI Units								
Ceiling Height	up to 9 m		9-13.5 m		13.5-18 m		18-30 m	
Type Of Sprinkler	Wet	Dry	Wet	Dry	Wet	Dry	Wet	Dry
Density (mm/min/m ²)	8	8	8	8	8	8	24	NA
Area of demand (m ²)	230	330	230	330	230	330	110	NA
Hose Demand (LPM)	950							
Duration (min)	60							

- **Type 2 Rolling Mill** (i.e. combustible loading driven by non-FM- approved hydraulic fluid): Design and install ceiling-level protection in accordance with Data Sheet 7-98, Hydraulic Fluids (i.e. hydraulic equipment should be designed in accordance with this data sheet) - e.g., proper piping design and construction, the use of noncombustible equipment components, automatic interlocks to shut down the hydraulic fluid pumping system in the event of a fire, etc. Provide automatic sprinkler protection in occupancies where hydraulic equipment is located. Design the system to provide 12 mm/min over 230 m² (0.3 gpm/ft² over 2500 ft²). Provide a water supply capable of meeting the design sprinkler discharge flow rate plus 1900 L/min (500 gpm) for hose streams, for a duration of 60 minutes.
- **Type 3 Rolling Mill** (i.e. combustible loading driven by petroleum-based ignitable rolling fluid): Design and install ceiling-level protection in accordance with Data Sheet 7-32, Ignitable Liquids, or preferably as per NFPA 13, using high temperature-rated sprinklers 141°C (286°F) as follows:
 - For rolling fluids having a flashpoint <38°C (100°F): Extra Hazard group 2 (EH2) 15.5 mm/min/m² over 280 m²# 0,38 gpm/ft² over 3,000 ft².
 - For rolling fluids having a flashpoint between 38°C (100°F) and 93°C (200°F): Extra Hazard group 1 (EH1): 11.6 mm/min/m² over 280 m²# 0,28 gpm/ft² over 3,000 ft².
 - For rolling fluids having a flashpoint > 93°C (200°F): Ordinary Hazard group 2 (OH2): 6.9 mm/min/m² over 280 m²# 0,17 gpm/ft² over 3,000 ft².

- **Mill Level Protection Design:**

- Also called Primary Mill-level (Equipment Level /“Low level”) when the mill is fully-enclosed or partially enclosed under an exhaust ventilation hood.
- Fire protection consists of an automatic deluge protection activated by a crossed-zone fire detection system, designed and installed per Data Sheet 5-48.
- Design the deluge system to deliver a density of 12 mm/min/m² (0.3 gpm/ft²) over the entire protected area.
- Install discharge nozzles around the mill proper as follows:



- On top of the stands on tending/operating and drive sides with coverage outside the stands, and within the roll stack covering the inside of the stands and rolls both above and below the pass line
- At coiler and recoiler above and below the pass line
- Above hydraulic cylinders
- Above roll bearings
- Under exhaust hoods/enclosures
- Above pits, pipe channels, tunnels, or collection pans extending from the mill where ignitable liquid may collect or combustible deposits may form
- Above any local ignitable liquid supply located within the mill footprint or immediately adjacent to the mill (i.e., hydraulic fluid or lubricating oil systems)
- When deluge nozzles are used to protect vertical mill surfaces, use the area of the vertical plan being protected to determine the necessary water discharge, nozzle spacing and coverage requirements.
- Refer to Data Sheet 7-78, Industrial Exhaust Systems, for guidance on protecting exhaust ventilation ductwork and downstream emission control equipment as follows:
 - In locations where the combustible duct exteriors (non-FM-approved ducts) are exposed to ceiling sprinklers, no other exterior protection is needed. If combustible ducts are located in an unsprinklered area and are of sufficient concentration or size to generate a self-propagating fire, install sprinklers over or near the duct, spaced not more than 3.7 m (12 ft) from the center. Generally, one line of sprinklers over the duct will suffice.

Base water supply on 75 L/min (20 gpm) per head over a maximum of 30 m (100 lineal ft) of duct, 74°C (165°F)-rated heads are satisfactory. When ducts are wide, sprinklers will also be needed underneath them if there are combustibles below the duct. See Data Sheet 2-0, Installation Guidelines for Automatic Sprinklers, for details.

If the duct is covered with foam plastic insulation (polyurethane, polystyrene, etc.), follow the surface treatment and sprinkler protection recommendations in Data Sheet 1-57, Plastics in Construction.
 - Install sprinklers inside all ducts that have cross-sectional areas greater than or equal to 516 cm² (80 in²), or those that have diameters greater than or equal to 254 mm (10 in.), and which:
 - A. are combustible (including non-FM-approved plastics; treat plastic-lined ducts the same way as plastic ducts)OR
 - B. contain combustibles likely to cause a damaging fire.

Use a minimum flow of 20 gpm (75 L/min) per sprinkler within the 100 ft (30 m) limit. In most cases, this will yield a density over the projected area much larger than the minimum 0.20 gpm/ft² previously specified.

Include a 250 gpm (945 L/min) hose stream demand.

Example: In a 2.4 m (8 ft) dia. by 60 m (200 ft) long duct, the projected design area will be: 2.4 m x 30 m max = 74 m² = 800 ft² (8 ft x 100 ft max).

Use wet systems for sprinkler protection where possible. If the ducts or associated equipment are subject to freeze, arrange these fire protection systems on a dry-pipe, deluge or non-freeze system.

Do not use steam or gaseous extinguishing systems as the primary protection system for ducts in lieu of automatic sprinklers.
- Provide blow-off caps for deluge nozzles to prevent ingress of solid material or oil that could plug the nozzles.



- **Supplementary Mill-Level Protection:**
 - When an ignitable rolling fluid is used, provide a total flooding (fully-enclosed) or local application gaseous extinguishing system, preferably a clean agent (*), (exhaust hood) as supplementary protection for the mill, to reduce the frequency of a large mill fire and enhance primary fire protection activation.
(*) **Gaseous extinguishing agent:** carbon dioxide (CO₂) is very dangerous for humans (lethal). As a result, for any normally occupied or occasionally occupied areas, we strongly recommend an automatic system using safe gaseous extinguishing agents for personnel, such as "Inergen" or "Argonite", or approved clean agents such as FE227 and FM200, in accordance with NFPA 2001. The recommended extinguishing agent density should be such that the oxygen concentration in the room does not drop below the safety limit.
- **Fire Water Supply:**
 - Design mill-level protection for simultaneous operations with ceiling-level protection.
 - Balance the hydraulic demands of both systems at the point of connection.
 - Include a hose stream allowance of 1,900 L/min (500 gpm) in the hydraulic design.
 - Duration:
 - Type 1 and 2 mills: 60 minutes
 - Type 3 mill:
 - 60 minutes for rolling fluids with a flashpoint > 93°C (200°F)
 - 90 minutes for rolling fluids with a flashpoint ≤ 93°C (200°F)

2.3. Hydraulic Fluids

- Most modern mills use hydraulic fluids for the vertical movements of the rolls and for exerting pressure on the metal. Various fluids may be used in the pressurized hydraulic system including rolling fluids and hydraulic fluids. Pressurized lube oil may also be used for roll bearing lubrication.

Prevention & Protection:

- All hydraulic groups should be protected, as recommended in section 11.

2.4. Rolling Fluids

- Heat is generated during rolling. A rolling fluid is sprayed onto the rolls and the metal to cool and lubricate them. The rolling fluid is sprayed, under pressure, through various types of spray nozzles arranged in rows (bars) parallel to the rolls and is heated by the metal and rolls.
- The rolling fluid is recirculated to the mill from a rolling fluid treatment plant. The fluid is cooled, filtered, its composition monitored and adjusted as needed, before being pumped back to the mill.
- For mills using oil-in-water emulsions (see below), recirculation is done either in a dedicated cut-off above-grade area away from the mill or in a separate building, due to the size of the equipment needed.
- The exact composition of the rolling fluid is considered by each rolling mill user as proprietary information.
- See fire hazards for mills classification based on the properties of the fluids used in rolling fluid and hydraulic systems.
- Water-based fluids are systematically used for hot rolling (usually around 95% water) as well as various oils and additives (usually around 5%).
- Both water-based and petroleum-based fluids are used for cold rolling (either water-based fluids (again usually containing up to 95% water) or petroleum-based with the



basic component being a petroleum product similar to kerosene. Petroleum-based cold rolling fluids have flashpoints ranging between 45 and 110°C (110 and 230°F).

- Water-based fluids are inherently less hazardous from a fire standpoint. However, oil droplets deposited on all surfaces of the mill (particularly on hot mills) can create a fire hazard (e.g. during maintenance operations.)

Prevention & Protection:

- Provide an interlock to effectuate an automatically Controlled Shutdown of the mill upon activation of the fire detection at the mill and/or within ancillary support equipment rooms/areas (i.e., rooms containing rolling fluid, hydraulic fluid or lubricating oil supplies). Initiate the trip upon activation of a primary fire protection system or an independent fire detection circuit/system.
- The Controlled Shutdown of the mill should include (but is not limited to):
 - The prompt depressurization of the ignitable rolling fluid, ignitable hydraulic fluid, and lubricating oil systems through fail-safe valves. Manual valves should also be installed in safe locations outside (where there is potential thermal exposure) in case of fire. If ignitable liquid systems serve multiple mills, the mills should be arranged to allow independent operations.
 - Close emergency fire-safe shutoff valves on the bottom of an ignitable liquid tank/reservoir or liquid filters (e.g., rolling fluid) during a fire.
 - Shut down applicable mill exhaust ventilation fans and close fire dampers.
 - Arrange for the ignitable rolling fluid returning from the mill (to the supply) to divert to a remote impound pit or reservoir upon actuation of primary fire protection systems (i.e., ceiling sprinklers or mill-level protection). The divert system is intended to prevent the returning fluid containing fire water from contaminating the rolling fluid supply, but also to not allow ignitable rolling fluid to accumulate inside the mill during a fire. Provide the appropriate fire protection over the emergency drainage pit or reservoir.
 - Provide at least one emergency shutdown switch for operators or fire service responders during a mill fire. Arrange the emergency shutdown switch to perform the interlock trip functionality mentioned above.
- See FM Global Data Sheets 7-64 for details
- Adequate fire protection measures should be provided, as recommended in section 6.2.2 Fire Hazards above.
- Deluge systems may be preferred for rolling fluid treatment plants. Adequate drainage for the entire fluid content and fire water should be provided.

2.5. Fume Exhaust

- During operations, the roll stack and the mill stand are surrounded by a mist of rolling fluid droplets and vapor.
- In order to reduce rolling fluid loss and improve both the housekeeping in the surrounding area and the comfort of the operators, most modern mills are equipped with a fume exhaust system comprised of a hood above the mill stand(s) connected by ducts to a fume-handling system.
- To further improve fume collection, movable panels may be installed on the lateral sides of the mill to enclose the working area. Some mill hoods are fitted with an air curtain at the periphery to trap the rolling fluid-laden air and improve the efficiency of the fume exhaust system.
- Some older mills, particularly hot mills, are not fitted with a local fume exhaust system and oil deposits may exist all around the mill and its appurtenances, including various pits, extending to the underside of the roof and its supporting structure.



Prevention & Protection:

- Provide an exhaust ventilation system over mills that use an ignitable rolling fluid in order to control flammable mist and vapor. Consider installing an exhaust ventilation system over mills using an emulsion or other rolling fluid that, if dried, forms a combustible deposit/residue. Design and install the ventilation system in accordance with FM Global Data Sheets 7-78, Industrial Exhaust Systems.
- Provide regular housekeeping based on the manufacturer's specifications and also on the residue accumulation report / observations, increasing frequency of cleaning when needed.
- Provide an interlock to automatically shut down applicable mill exhaust ventilation fans and close fire dampers. This should be part of the Controlled Shutdown of the mill upon activation of fire detection at the mill and/or within ancillary support equipment rooms/areas (i.e., rooms containing rolling fluid, hydraulic fluid, or lubricating oil supplies). The trip is initiated upon activation of a primary fire protection system or an independent fire detection circuit/system.
- Adequate fire protection should be provided as recommended in section 6.2.2 Fire Hazards above.

2.6. Combustible Dust Hazard

- At aluminum rolling mills, aluminum chips and turnings, generated by scalping ingots or trimming rolled material, tend to produce larger, coarse particles along with some finer ones.
- The larger waste generated by these operations is collected for recycling. Collection systems may be as simple as gravity-fed refuse bins, or more complex conveying systems including belt conveyors.
- These operations may represent a dust explosion hazard if the overall particle distribution is sufficiently small, or the finer aluminum ones separate out from the coarser particulate (e.g., in a dust control system filter).
- In a finely divided powder form, aluminum will also react with boiling water to form hydrogen and aluminum hydroxide. This reaction also takes place in cold water but at a slower rate.

Prevention & Protection:

Courtesy of Franck Orset (FPO) Loss Prevention Engineer:

- Dust control measures.
- One obvious place for a dust explosion to initiate is where dust is produced.
- In equipment such as dust collectors, a combustible mixture could be present whenever the equipment is operating.
- Other locations to consider are those where dust can settle, both in occupied areas and in hidden concealed spaces.
- The dust-containing systems (ducts and dust collectors) should be designed in such a manner (i.e., no leaking) that fugitive dust will not accumulate in the work area.
- A strong housekeeping program should be implemented, with regular cleaning frequencies established for floors and horizontal surfaces, such as ducts, pipes, hoods, ledges and beams, to minimize dust accumulation inside operating areas of the facility.
- The working surfaces should be designed in a manner that minimizes dust accumulation and facilitates cleaning.
- Facilities should carefully identify the following in order to assess their potential for dust explosions:
 - Materials that can be combustible when finely divided
 - Processes which use, consume, or produce combustible dust



- Open areas where combustible dust may build up
- Hidden areas where combustible dust may accumulate
- Means by which dust may be dispersed in the air
- Potential ignition sources.
- The following are some possible recommendations for dust control:
 - Minimize the escape of dust from process equipment or ventilation systems
 - Use dust collection systems and filters
 - Utilize surfaces that minimize dust accumulation and facilitate cleaning
 - Provide access to all hidden areas to permit inspection
 - Inspect for dust residue in open and hidden areas at regular intervals
 - Clean dust residue at regular intervals
 - Use cleaning methods that do not generate dust clouds if ignition sources are present
 - Only use vacuum cleaners approved for dust collection
 - Locate relief valves away from dust hazard areas
 - Develop and implement a hazardous dust inspection, testing, housekeeping, and control program (preferably in writing, with established frequency and methods).

Ignition Control Measures:

- Basic precautions are required to avoid a possible ignition source leading to an explosion with combustible dust:
 - Strict no smoking policy within the premises
 - Strict and adequate Hot Work Permit procedure in place
 - Use of spark-resistant tools (for maintenance, repairs, replacement of material/equipment etc.)
 - Removal of static electricity (bonding and grounding with permanent ground wires for equipment, machines, ductworks used for pneumatic conveying systems, grounding of personnel during hazardous operations etc.)
 - Control of friction hazard (to minimize the possibility of friction sparks)
 - Protection of bearings (ball or roller bearings should be sealed against dust)
 - Use appropriate electrical equipment and wiring methods. Electrical power and control should be in keeping with the environment. Use explosion-proof electrical appliances wherever necessary
 - Use separator devices to remove foreign materials capable of igniting combustibles from process materials
 - Separate heated surfaces from dust
 - Separate heating systems from dust
 - Proper use and type of industrial trucks (only industrial trucks that are approved for combustible dust locations should be selected and used)
- Hazards related to the collection of combustible dust should be carefully studied and approved safe methods carefully selected.
- See NFPA standards for more details (i.e. NFPA 484 for combustible metal dust).

Prevention Measures:

Employees should be specifically trained in the explosion hazards of combustible dust.

- Workers are the first line of defense in preventing and mitigating fires and explosions. If the people closest to the source of the hazard are trained to recognize and prevent hazards associated with combustible dust in the plant, they can be instrumental in recognizing unsafe conditions, taking preventive action, and/or alerting management. All employees should be trained in safe work practices applicable to their job tasks, as



well as in the overall plant programs for dust control and ignition source control. They should be trained before they start work and periodically refresh their knowledge, when reassigned, or when hazards or processes change.

- A team of qualified managers should be responsible for conducting a facility analysis (or for having one done by qualified outside persons) prior to the introduction of a hazard, and for developing a prevention and protection scheme tailored to their operation. Supervisors and managers should be aware of - and support - the plant dust and ignition control programs. Their training should include identifying how they can encourage the reporting of unsafe practices and facilitate abatement actions.

Protection Measures:

- An emergency action plan should be implemented.
- Dust collectors should not be located inside the buildings, particularly dry collectors.
- Rooms, buildings, or other enclosures (dust collectors) should be provided with an explosion relief venting outlet distributed over the exterior wall of buildings and enclosures. Explosion venting should be directed to a safe location away from employees and other critical pieces of equipment.

2.7. Mill Equipment

Reheat Furnace:

- Re-heat furnaces are a major bottleneck in a rolling mill.
- Potential accumulation of gas inside the furnace during startup may lead to an explosion upon ignition.

Prevention & Protection:

- Adequate safety combustion controls should be provided for the main fuel gas line and the burners, as recommended in section 11.

Remelt Shop:

- External scrap may introduce contaminants that could jeopardize the finished product quality but also introduce major hazards such as: high moisture content, liquid in containers (e.g. cans) or even radioactive material. Some rolling mills only accept their own internal scrap.
- Steam explosions in furnaces, caused by violent boiling or flashing of water into steam, may occur when water is rapidly heated by the interaction of molten metals. This can sometimes happen in furnaces.
- Explosions due to fuel/gas leaks or an accumulation inside a fuel/gas-fired furnace may occur during the startup of operations.
- Different methods are used for mold lubrication or coating (e.g. nanotech, consisting of a fine powder of mineral material or an emulsion involving mineral oil in water or a graphite-based coating). Coatings are usually applied following a regular schedule (e.g. every 2 weeks).
- Some molds are air-cooled and others are water-cooled requiring a large amount of water (e.g. 1,000 cum/hr) circulating in a closed-loop, including cooling towers.

Prevention & Protection:

- Strict control procedure of both internal and external scraps should be established and enforced including, but not limited to, the detection of liquid, moisture content monitoring, detection of radioactive material, etc.
- Strict moisture content of scrap should be enforced. Solid scrap should not be introduced into molten liquid but rather remelted from the solid state into a liquid first, before entering the furnace.



Client Guidance Note - Risk Control Practice

- Adequate safety combustion controls should be provided on the fuel gas lines, as recommended in section 11.
- Noncombustible mold lubricant and coating is preferred.

Rolling Mill Stands:

- Stands include very critical equipment such as rolls, gears and drivers, hydraulic and lubricating groups.
- The reliability and availability of the above equipment is key.

Prevention & Protection:

- Major roll-bearing on-line vibration monitoring is necessary (with displacement checked on a monthly basis).
- Workshop capabilities are important.
- An adequate Maintenance and Inspection program is key. This includes, but is not limited to:
 - A reliability team focusing on rotating equipment and electrical equipment (“bad actor tracking”) and conducting root cause analyses to eliminate failures
 - Computerized Maintenance Management System (MMS) job order editing – “time-based maintenance”, overdue list, spare parts’ management, bad actor tracking - KPI
 - A training program dedicated to maintenance teams for new projects
 - Welders’ re-qualifications compliant with ATSM standards
 - A once-a-year turnaround schedule (e.g. 10 days duration for each process unit)
 - Instrumentation (calibration of process instruments / protective devices):
 - Oil pressure gauges/temperature sensors/ flow sensors
 - Vibration probes / other measuring devices
 - Rolling Mill drive gears maintained as per manufacturer’s specifications
 - Rolling Mill stands geometry regularly checked (e.g. every year, including geometry and alignment of the frame, driving shaft, gears and driver). All operations should be documented
- Technical agreement with manufacturer allowing for quick repair and maintenance.

Mill Drive Motor:

- Several thousand-horsepower drives introduce severe electrical breakdown hazards.
- These pieces of equipment are very critical and present long lead times for repairs or replacement.
- Lubricating oil is found in mill drive motors and gear boxes. The systems vary in oil volume from tens to hundreds of gallons (tens to thousands of liters). Lubricating system operating pressures generally range from 20 to 60 psi (1.4 to 4.1 bars) but may occasionally exceed 100 psi (6.9 bars), while oil flow rates tend to be low, using small diameter supply piping and larger diameter piping for low pressure or gravity return, both presenting more of a pool fire hazard. Lubricating oil supplies may consist of a small console adjacent to the use point or a remote large central supply located in a below-grade space (i.e., oil cellar) for older mills, or in a mill-level cutoff room serving multiple use points. Most lubrication oil systems present a pool fire exposure.

Prevention & Protection:

- Locate mill drive motors in above-ground rooms cut off from the mill and any ignitable liquid supplies such as rolling fluid, hydraulic fluid and lubricating oil.
- Construct a 1-hour fire-resistant wall between the mill proper and the mill drive motors. Preferably construct the wall of masonry so as to prevent firefighting hose streams penetrating through the wall. An alternative to a fire-resistant wall is a noncombustible



wall (e.g., sheet metal on steel frame) with a line of deluge water spray nozzles along the mill side of the wall arranged to activate automatically over the mill upon detection of fire.

- Cabling should be protected against mechanical damages, combustible liquid, residue and dust accumulation. Cable routes should be arranged in order to minimize potential fire exposure.
- Adequate air- cooling systems should be installed.
- Online temperature monitoring of drivers and an air sampling fire detector should be provided inside the enclosure.
- An adequate maintenance and inspection system should be established and well enforced,
- covering, amongst others, mechanical & electrical integrity as well as electric condition and vibration monitoring.
- A technical agreement with the manufacturer should be entered into allowing for quick repairs and maintenance.
- Spare mill drive motors should be available on site and stored in a safe location (see spare parts warehouse). This should be part of the Contingency Plan.
- Adequate fire protection should be provided for lubrication systems as per section 11.

Lifting Equipment:

- Lifting equipment (rolling cranes) are critical for moving heavy equipment (e.g. rolls inside the Rolling Mill).

Prevention & Protection:

- Proper maintenance and inspection of that critical lifting equipment is paramount.
- This lifting equipment should be duplicated for a given rolling mill line and adequately parked when not in use, so that there is no mutual exposure between the lifting equipment and the process equipment.
- Overhead cranes should be adequately parked and detection protection installed when needed, as recommended in section 11.

2.8. Utilities

Electric Room / Motor Control Centers:

- The fire hazards present in electrical or control equipment rooms of a Rolling Mill may constitute a more severe exposure than in other occupancies.
- These large, expansive equipment rooms often contain a large quantity of equipment that is sensitive to heat, water and smoke (e.g. variable frequency drives).
- Electrical fires, such as in cable insulation, may not be intense but can produce significant quantities of corrosive combustion products and generate smoke that can hinder firefighting.

Prevention & Protection:

- Locate electrical equipment in above-ground rooms cut off from the mill and any ignitable liquid supplies such as rolling fluid, hydraulic fluid and lubricating oil.
- An asset integrity program for electrical equipment can help prevent electrical breakdowns that could result in ignition of electrical equipment.
- Adequate fire protection for substations / electric rooms, MCC rooms and oil-filled transformers should be provided, as per section 11.



Fuel Gas supply:

- Fuel supply for the furnaces of the Remelt Shop is key. Burners can be dual-fired (fuel oil / CNG).
- Gas metering / delivery / pressure reduction & filtration station can be on site.

Prevention & Protection:

- Dual fuel oil / CNG gas-fired furnaces are preferred providing a full back up of fuel. An adequate buffer storage of fuel oil and supplies should be provided.
- Gas ducts, well separated from the grid, also provide adequate backup.
- Gas metering / delivery / pressure reduction stations should be equipped with intrinsically safe electrics (ATEX) and piping should be protected against mechanical impacts (e.g. vehicles).

Fume Treatment:

- Fume Treatment is very critical for the treating of fumes / gas issued from the fume exhaust system. As per legal requirements (environmental considerations), the Rolling Mill may not be able to operate without a Fume Treatment system.

Prevention & Protection:

- Redundancies of key equipment (dual PLCs in different fire areas) and spare capacity should be provided for the Fume Treatment system.
- The electrical room should be protected, as recommended in section 11.

Cooling System:

- National grids and/or water treatment plants provide make-up water for a closed recycling loop (thus, in limited volumes). Usually, there are no open cycles.
- Cooling water on a recycling loop may represent the following volumes (numbers given by way of example):
 - 4,000 cum per day for the cooling system of the Remelt Shop
 - 25,700 cum per day for the cooling system of Hot Mill / Cold Mill 1 and Finishing Line 1
 - 18,000 cum per day for the cooling system of Cold Mill 2 and Finishing Line 2
- Cooling Towers are therefore critical.

Prevention & Protection:

- The critical cooling water tower should be protected, as recommended in section 11.
- Redundancies and spare capacity should be provided.

Steam Boilers:

- A fuel oil / gas-fired steam boiler can be used for supplying dry, saturated steam for Cold Mill coolant temperature control.
- It is reported that Cold Mills usually operate without this boiler.

Prevention & Protection:

- The criticality of such a boiler should be clearly established.
- When critical, adequate and well segregated backup should be provided.
- Adequate safety combustion controls should be provided, as recommended in section 11.

Compressed Air:

- Usually in packaged units for various uses inside the Rolling Mill.



Prevention & Protection:

- Redundancies and spare capacity should be provided. The air compressor room should at least be protected by an automatic fire detection system.
- Air compressors containing a large quantity of oil should be protected (over postulated oil spill or compressed air foam), as per section 11.

2.9. Control System

- Operations control in modern rolling mills is computer-assisted.
- Rolling parameters are constantly monitored by various sensors and monitoring devices.
- These devices are “wired” to programmable logic controllers, microprocessors and/or computers, which in turn are “wired” to the hydraulic actuators and electric motors.

Prevention & Protection:

- Locate control equipment in above-ground rooms cut off from the mill and any ignitable liquid supplies such as rolling fluid, hydraulic fluid and lubricating oil.
- Depending on the arrangement, cyber security and a so-called “data recovery plan” for IT (i.e. loss of data) should be considered.
- Server room: when redundant servers are provided, they should be located in different areas. In case only one server is provided, a Contingency Plan and adequate automatic fire protection system should be provided (See Rec. for Electric Rooms in section 11).

2.10. Spare Parts Warehouse

- Critical and very expensive spares are usually stored in one or more warehouses. Heavy spares (e.g. spare drivers) and consumables are usually well separated. The inventory can represent several Million USD (e.g. \$20-40-60-80Mio or more).
- These spares are critical to the process and can have a relatively long lead time. Some consumables used in relatively large quantities and/or having a long lead time are also deemed as critical. A major loss in such a warehouse could lead to BI for the related units due to lack of replacement parts/spares.

Prevention & Protection:

- Critical spares should be clearly identified. The commodity class should be clearly established as per NFPA and the warehouse should be provided with adequate and approved automatic fire detection / protection, as per section 11.
- Flammable and combustible liquids and spray cans should not be stored in such a warehouse but rather in a dedicated safe area. Hazmat and compressed gases should be stored and protected, in accordance with section 11.



2.11. Contingency / Business Continuity / Recovery Plan

Warning: in order to be reliable, Contingency / Business Continuity / Recovery Plans should be formalized. This would include formal contracts being established with vendors or third parties in advance. The plans should be regularly tested, reviewed and updated.

Holistic view:

- If the Rolling Mill is part of a group with a relatively high level of vertical integration in the aluminum industry, a Business Continuity Plan (BCP) at corporate level should be developed for the main identified risks in each and every process unit.
- The impact of a loss impacting thirds parties (i.e. logistics, utilities) should be investigated and an adequate BCP should be established.

Site view:

- **Electrical power:** full backup for electric power supply is preferred. This could consist of two feeders from different substations fed from a national grid loop or one feeder from the national grid backed up by a Captive Power Plant (in case the Rolling Mill is part of a complex).
- **Raw Material Supply** (e.g. slabs): Business Continuity Management at the level of the Rolling Mill would consist of (or be a combination of):
 - A long-term agreement with the main supplier for the delivery of slabs (e.g. 10 years).
 - Slabs alternate suppliers identified and contracts settled.
 - Coils (Work in Progress material) to be processed in Cold Mills purchased overseas in order to compensate for the missing slabs (e.g. 20%).
 - Aluminum scrap, high grade aluminum ingots and alloying tablets purchased on the market (from, US, China, Europe).
 - For additives such as Magnesium, Copper or Titanium: various suppliers and alternate suppliers identified.
- **Finished Products:** agreements settled with a competitor located in another market (but producing the same products) in order to supply the full design production capacity of the Rolling Mill (e.g. 160,000 tons) of finished products for one year.
- **Critical Spares:** around 24 months for the replacement of a rolling mill stand (of which 8 months for studies and tender, and 6 months for manufacturing and shipping). A pair of work rolls for the Rolling Mill would amount to around USD 90k and 12 months for replacement). As a result, enough spares and a replacement schedule should be organized in order to prevent any shortage. For instance:
 - Critical parts identified
 - Rolls and chocks available on site:

Item	Sub items	Hot Mill	Cold Mill 1	Cold Mill 2
Chocks:	Work rolls	3 sets	4 sets	4 sets
	Backup rolls	2 sets	2 sets	2 sets
Rolls:	Work rolls	11 sets	10 sets	12 sets
	Backup rolls	5 rolls	4 rolls	4 rolls

- **Technical support agreement** with a manufacturer for the Rolling Mill process control system (PLC, HMI)



3. LOSS HISTORY

According to multiple sources, the largest losses in a rolling mill are almost equally split between:

- Fire:
 - Involving hydraulic fluid, rolling fluid
 - Inadequate supplementary protection (e.g. CO₂) at equipment level and ceiling protection
 - Ignition sources including hot surfaces (break pit) and poorly controlled hot work
- Machinery Breakdown
 - Involving gear boxes, work rolls
- Electrical
 - Involving large drive motors or power supply components
 - Fire following in about 1/3 of the cases

4. LOSS ESTIMATES

Maximum Possible Loss (Technical MPL – SCOR):

- A major fire inside the Rolling Mill involving combustible fluids (hydraulic and/or rolling and lubricating) and combustible construction, if any. (i.e. sandwich panels with plastic-based insulation).
- **MPL PD** = 100% of the Rolling Mill in the case of a single building. In the case of multiple buildings, please refer to the MPL Handbook for minimum separating distances and apply the MPL to the building with the largest values (PD & BI).
- **MPL BI** = 24 months
- Induced BI should be considered if there are interdependencies with sister plants upstream and/or downstream. This could be mitigated by buffer storage (providing some extra days of production) and an alternate supplier (if any).

Probable Maximum Loss (Market definition):

Note that in terms of loss estimates at SCOR only MPL and NLE are considered. There is no leeway for using any other acronym or definition (i.e. EML, PML, etc.). EML or PML are only given for information.

- Major impairment of one sprinkler system. All other systems are operating. For a Type 1 Rolling Mill the surrounding systems may be able to control the fire which could then be extinguished by the firefighters.
- **PML PD** = 50% of the Rolling Mill in the case of a single building. In the case of multiple buildings, please refer to the MPL Handbook for minimum separating distances and apply the MPL to the building including the largest values (PD & BI).
- **PML BI** = 12 months
- Induced BI should be considered if there are any interdependencies with sister plants upstream and/or downstream. This could be mitigated by buffer storage (providing some extra days of production) and an alternate supplier (if any).

Normal Loss Expectancy (NLE – SCOR):

- Fire starting inside the Rolling Mill.
- **NLE PD**: If there is an adequate and reliable sprinkler system, the damages are limited to equipment (the building is not damaged) on a surface equivalent to the surface of application of the ceiling sprinkler (see Fire Hazards section above. In the case of a non-adequate sprinkler system (design and/or reliability issue), please refer to the MPL and PML above.



- **NLE BI:** About 3-4 months BI for replacing damaged equipment. In the mean-time, the Rolling Mill is shut down.

Another scenario:

- Fire in a substation, electric room or MCC room (starting in an oil-filled transformer or in cabinets or in ceiling cables, spreading or not to the adjacent areas depending on passive fire protection – i.e. segregation).
- **NLE PD:** total loss of the substation, electric room or MCC room if there is no adequate and reliable fixed fire protection.
- **NLE BI:** at least 4 up to 6-8 months BI for replacing the damaged equipment. In the mean-time, the related unit / Rolling Mill is shut down.

Another scenario:

- Fire involving a set of cooling towers.
- **NLE PD:** total loss of the cooling tower (e.g. USD 600k) if there is no adequate and reliable fixed fire protection.
- **NLE BI:** at least 4 months BI for replacing the damaged equipment. In the mean-time, the related unit / Rolling Mill is shut down.

Note:

- The above scenario mostly considers a single Rolling Mill building housing different mills (hot/cold). Considering the internal interdependencies, a fire in the Hot Mill would induce BI in the Cold Mill(s) (downstream) if there is no reliable & proven Contingency Plan (CP). Moreover, the Contingency Plan (CP), whether or not it exists, is not taken into consideration for the MPL case.
- Induced BI should be considered if there are any interdependencies with sister plants upstream and/or downstream. This could be mitigated by buffer storage (providing some extra days of production) and an alternate supplier (if any).



VII - RECYCLING FOCUS

1. PROCESS

- **Typical Can Reclamation Unit (CRU) - process flow diagram & process:**

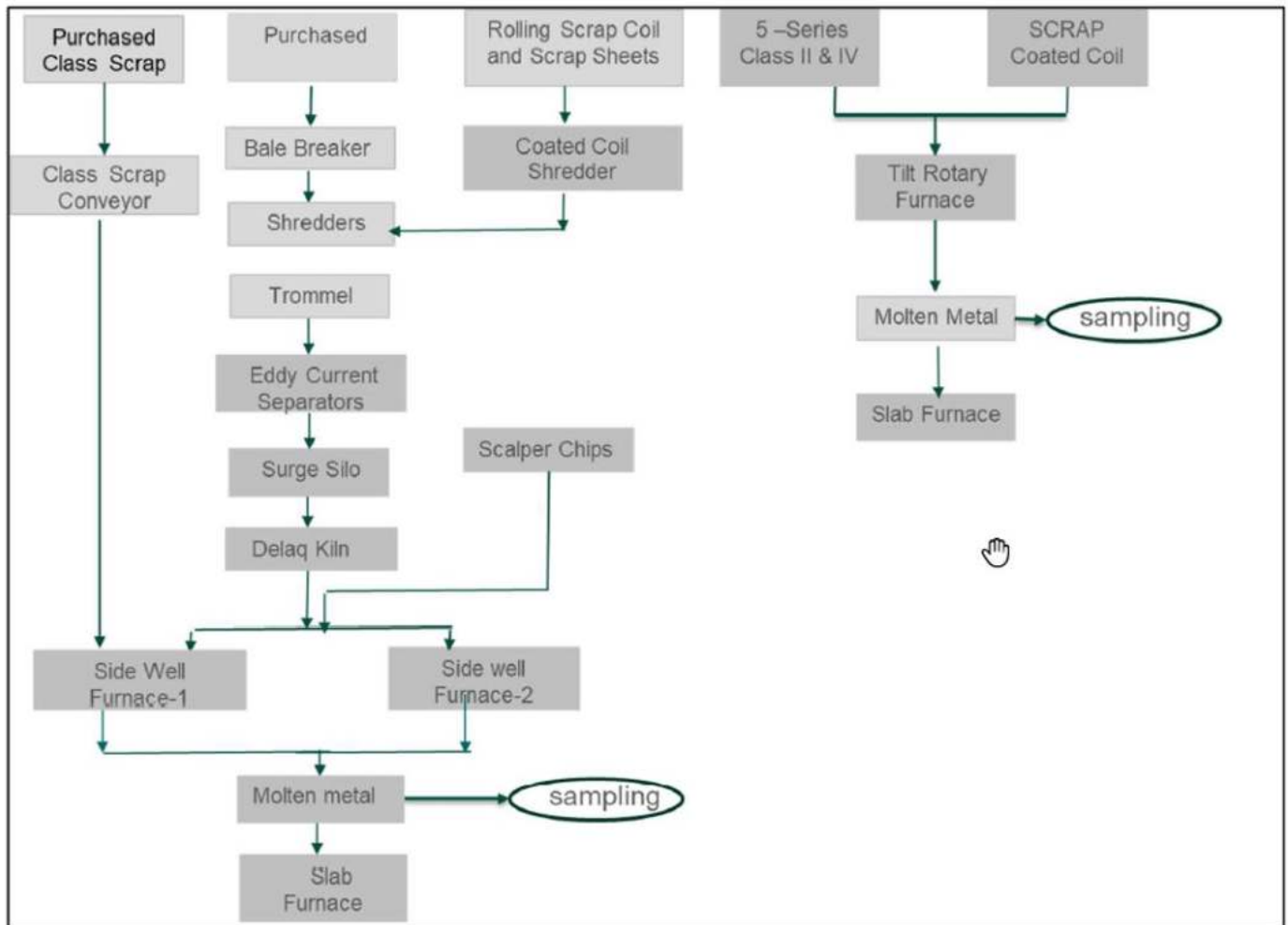

Courtesy of Virtual i Technologies Ltd, Risk Engineering Service Provider for Aon in the Middle East



Coated scraps and other Class III (Class 1 being “best quality”, uncoated) cans are purchased globally in bales and fed to the bale breaker, then the shredder, both by conveyor.

Rolling Mill scrap (if any on the complex), coated coils and sheets are also fed into the shredder. Aluminum scalper chips are also sourced from the Rolling Mill and stored in a silo for direct feed to the remelt furnaces.

The scrap from the shredder is pumped through a trommel (rotary) screen for material separation. It is then passed through two de-magnetizing screens and fed by an inclined conveyor to a Surge Silo (e.g. 80 mt capacity).

The scrap is then fed by conveyor to the de-lacquering kiln for removal of lacquer before being front-loaded into the two remelt furnaces. The molten metal is pumped out of the furnaces.



The de-lacquering kiln has two burners, with a pre-heater operating at 850°C and the kiln at 530°C. The two remelt furnaces normally operate at around 750°C and are located 10 m apart. A manually-opened pit is provided between the furnaces for molten metal release.

Class 1 (uncoated) Can scraps do not need to be de-lacquered and are fed via conveyor directly to the remelt furnace.

Coated Class II & IV Can scraps and scrap-coated coils are directly fed into the Tilt Rotary Furnace and the molten metal is then pumped out of the furnace.

Two fume units and one dust collector unit are provided, with the dust collector for the cold metal (shredding) operations and the fume units for hot processing.

2. SPECIAL HAZARDS & RISK CONTROL

Special hazards, prevention, protection and potential mitigation measures are detailed below for each and every special hazard related to this occupancy. Related recommendations are also mentioned “(see. Rec)”. Please refer to section 11. “Support for Loss Prevention Recommendations” for details.

2.1. Construction

- CRU buildings may include plastic-based material such as sandwich panels with plastic insulation (i.e. PIR, PUR, EPS).

Prevention & Protection:

- Construct buildings or rooms containing a CRU and other associated equipment using noncombustible building construction materials.
- If combustible or plastic building materials are required, use FM-approved materials. Combustible building construction may include insulated metal panels, insulated steel deck roof assemblies and interior plastic facings. Install FM-approved building materials in accordance with the manufacturer’s guidelines and their FM Approval listing.
- EPS-insulated sandwich panels should not be permitted on the ceiling. There is no suitable fire protection system for such material installed on the ceiling.

2.2. Conveyor

- Inclined, covered and/or elevated conveyors represent serious fire hazards.

Prevention & Protection:

- Adequate fire protection should be provided, as recommended in Section 11.



2.3. Remelt Furnace & De-lackering Kiln

- The potential accumulation of gas inside the furnace during startup may lead to an explosion upon ignition.



Prevention & Protection:

- Adequate safety combustion controls should be provided for the main fuel gas line and the burners, as recommended in Section 11.

2.4. Hydraulic & Lubricating groups

- Large hydraulic & lubricating groups involving large volumes of combustible may expose the nearest process equipment.

Prevention & Protection:

- Adequate fire protection should be provided, as per Section 11.

2.5. Utilities

Electric Room / Motor Control Centers:

- Fire hazards in electrical or control equipment rooms.
- Electrical fires, such as in cable insulation, may not be intense but can produce significant quantities of corrosive combustion products and generate smoke that can hinder firefighting.

Prevention & Protection:

- Locate electrical equipment in above-ground rooms cut off from the mill and any ignitable liquid supplies such as hydraulic fluid and lubricating oil.



- An asset integrity program for electrical equipment can help prevent electrical breakdowns that could result in the ignition of electrical equipment.
- Adequate fire protection measures for substations / electric rooms, MCC rooms and oil-filled transformers should be provided, as per Section 11.

Fuel Gas supply:

- Fuel supply for the remelt furnaces and the de-lacquering kilns is key. Burners can be dual-fired (fuel oil / CNG)
- Gas metering / delivery / pressure reduction & filtration station can be on site

Prevention & Protection:

- Dual fuel oil / CNG gas-fired furnaces are preferred providing a full backup of fuel. Adequate buffer storage of fuel oil and supply should be provided.
- Gas ducts well separated from the grid also provide adequate backup.
- Gas metering / delivery / pressure reduction stations should be equipped with intrinsically safe electrics (ATEX), and piping should be protected against mechanical impacts (e.g. vehicles).

Fume & Dust Treatment:

- Fume Treatment is very critical for the treating of fumes & dust emitted from the fume & dust exhaust system. As per legal requirements (environmental considerations), the CRU may not be able to operate without a proper Fume & Dust Treatment system.

Prevention & Protection:

- Redundancies of key pieces of equipment (dual PLCs in different fire areas) and spare capacity should be provided for the Fume & Dust Treatment system.
- The electrical room should be protected, as recommended in Section 11.

Cooling System:

- Cooling water may be used for the molds.
- National grids and/or water treatment plants provide make-up water for a recycling closed loop (thus, in limited volumes). Usually there are no open cycles.
- However, cooling water on a recycling loop may represent an important volume of water (e.g. 1,000 cum/h).
- Cooling Towers are therefore critical.

Prevention & Protection:

- The critical cooling water tower should be protected, as recommended in Section 11.

2.6. Control System

- Relatively high levels of automation are usually noticed for such occupancies (low margins requiring high efficiency). As a result, the Control System may be highly critical (for economic sustainability).

Prevention & Protection:

- Depending on the arrangement, cyber security and a so-called “data recovery plan” for IT (i.e. loss of data) should be considered.
- Server room: when redundant servers are provided, they should be located in different areas. If only one server is provided, a Contingency Plan and an adequate automatic fire protection system should be provided (See Rec. for electric rooms).



2.7. Spare Parts Warehouse

- Critical and very expensive spares are usually stored in one or more warehouses. Heavy spares and consumables are usually well separated. The inventory can represent several Million USD (e.g. \$20-40-60-80 Mio or more).
- These spares are critical to the process and can have a relatively long lead time. Some consumables used in relatively large quantities and/or having a long lead time are also deemed as critical. A major loss in such a warehouse could lead to BI for the related units, due to lack of spares.

Prevention & Protection:

- Critical spares should be clearly identified. The commodity class should be clearly established as per NFPA and the warehouse should be provided with adequate and approved automatic fire detection / protection, as per Section 11.
- Flammable and combustible liquids and spray cans should not be stored in such warehouses but, rather, in a dedicated safe area. Hazmat and compressed gases should be stored and protected, in accordance with Section 11.

3. CONTINGENCY / BUSINESS CONTINUITY / RECOVERY PLAN

Warning: in order to be reliable, Contingency / Business Continuity / Recovery Plans should be formalized. This would include formal contracts established in advance with vendors or third parties. The plans should be regularly tested, reviewed and updated.

Holistic view:

- If the Can Recycling Unit (CRU) is part of a group with a relatively high level of vertical integration in the aluminum industry, a Business Continuity Plan (BCP) at corporate level should be developed for the main identified risks in each and every process unit.
- The impact of a loss impacting thirds parties (i.e. logistics, utilities) should be investigated and an adequate BCP should be established.

Site view:

- Electrical power: full backup for electric power supply is preferred. This could consist of two feeders from different substations fed from a national grid loop, or one feeder from the national grid backed up by a Captive Power Plant (in case the CRU is part of a complex).
- Raw Material Supply (i.e. Cans): Identify and settle contracts with alternate suppliers.



4. LOSS ESTIMATES

Maximum Possible Loss (Technical MPL – SCOR):

- Major fire starting on a conveyor or in hydraulic / lubricating groups:
- **MPL PD:** Total loss of the CRU process area.
- **MPL BI:** 18-24 months
- Induced BI should be considered if there are any interdependencies with sister plants upstream and or downstream. This could be mitigated by buffer storage (providing some extra days of production) and an alternate supplier (if any).

Probable Maximum Loss (Market definition): Loss Expectancy similar to MPL

Note that in term of loss estimates at SCOR only MPL and NLE are considered. There is no leeway for using any other acronym or definition (i.e. EML, PML, etc.). EML or PML are only given for information.

Normal Loss Expectancy (NLE – SCOR):

- Major fire starting on a conveyor or in hydraulic / lubricating groups but controlled by the sprinkler system (if any). The rest of the scenario is the same as for the MPL):
- **MPL PD:** Limited to the protected unit
- **MPL BI:** between 1-2 weeks up to 3 months depending on the equipment
- Induced BI should be considered if there are any interdependencies with sister plants upstream and/or downstream. This could be mitigated by buffer storage (providing some extra days of production) and an alternate supplier (if any).



VIII - CALCINATION PLANT FOCUS

1. PROCESS

Petroleum coke is a by-product of the coker process that occurs in the oil industry. Also known as "green petroleum coke" or Raw Petroleum Coke (RPC), calcined petroleum coke is a very important link between the oil and metallurgical industries and is used in multiple applications.

Calcined Petroleum Coke (CPC) is manufactured from Raw Petroleum Coke (RPC) by a process known as High Temperature Pyrolysis.

Coke calcinating plants can be located in oil refineries, in captive plants in aluminum smelters or in merchant plants.

The Calcination Plant is usually located off site or at the port producing Calcined Pet Coke (CPC) for a dedicated smelter (when integrated) and/or for other smelters (i.e. export).

Basic calcinating process:

Petroleum coke calcination is a three-step process, including drying, devolatilization and densification. The coke calcination process is a time-temperature function, conducted in an oxygen-deficient atmosphere. Important control variables are: heating rate, air addition rate and final calcination temperature. To obtain the calcined coke properties required by the carbon and graphite industries, the coke must be subjected to temperatures of 1150-1350°C (or higher) to achieve density and conductivity.

The final quality of the calcined coke is directly related to the specific characteristics and quality of the green coke fed to the calciner. While calcination cannot improve upon certain quality limits inherent in the green coke, potential quality can be lost by improper calcining.

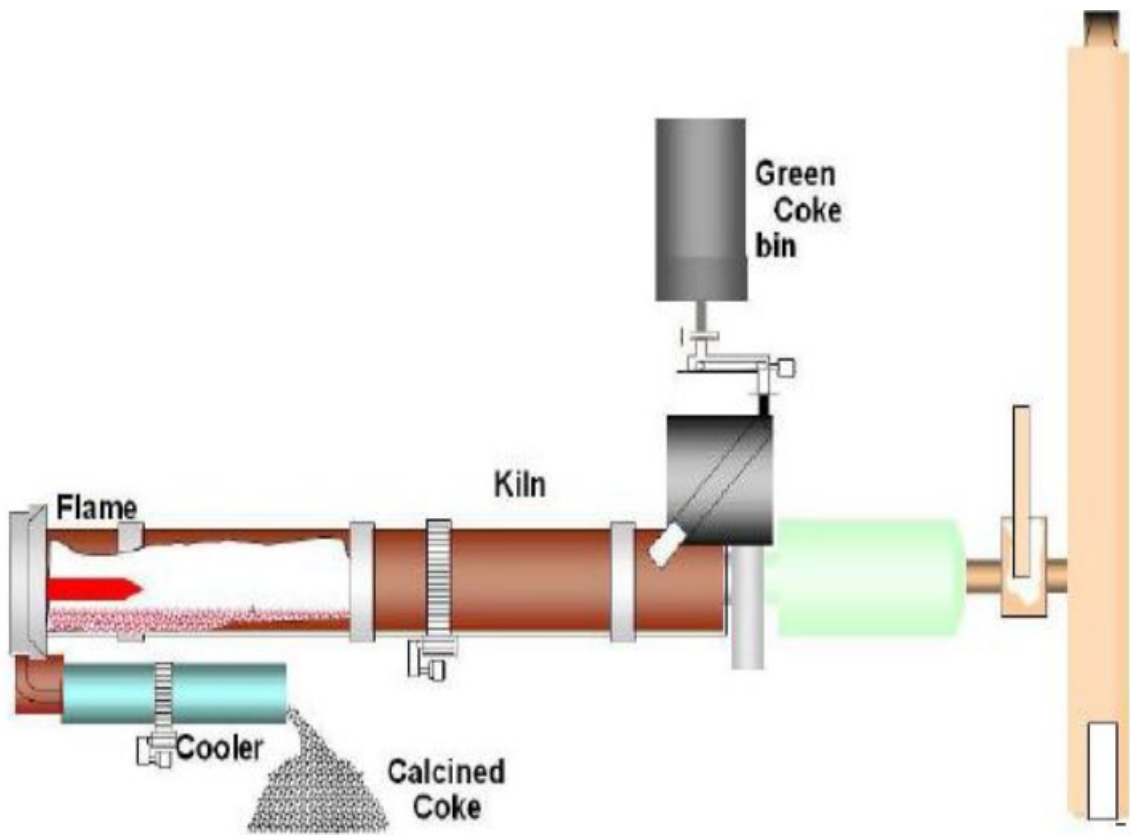

Courtesy of Aluminium Bahrain B.S.C. (Alba) – Calcination Plant & Marine Area



Process Step details:

- **Rotary Kiln:** The petroleum green coke is fed into a refractory-lined rotary kiln where the volatiles are driven off during the calcining process in an oxygen-deficient atmosphere. Air can be injected through the kiln shell to burn a portion of the volatile matter in the kiln providing usable heat to the kiln.
- **Cooling:** Once the calcined coke is discharged from the kiln, the coke is cooled in a rotary cooler. At the feed end of the cooler, water is sprayed on the calcined coke to cool the coke to acceptable temperatures. The water is evaporated in the process.
- **Afterburner:** The kiln exhaust gas is oxygen-deficient and contains volatile matter released in the kiln. The kiln exhaust gas is directed to an afterburner (secondary combustion chamber) and air is injected to burn the volatiles and dust. A waste heat recovery boiler is used to produce steam from the heat contained in the afterburner exhaust gas.

Notes:

- **Coke feed flexibility:** Some rotary kilns can handle a wide range of green coke feeds including needle, sponge, shot, fluid or tar pitch green cokes. The rotary kiln is also able to optimize the coke calcining operating parameters, be it residence time or temperature gradient and heat-up rate, all of which impact product quality. Coke kilns can be fueled with: gas, heavy oil, oil, refinery gas, waste oil and solid fuel, fired independently or in combination.
- **Calcined Petroleum Coke (CPC) Physical Properties:** Pet coke or coal tar pitch: When calcined at a temperature around 1300°C (2370°F) prior to use, petroleum coke can be considered practically inert, virtually noncombustible and definitely nonexplosive. More than 25% of the pet coke can be supplied from recycled used anodes and 5% from rejected green anodes.



Courtesy of Aluminium Bahrain B.S.C. (Alba) – Calcination Plant & Marine Area



2. SPECIAL HAZARDS & RISK CONTROL

Special hazards, prevention, protection and potential mitigation measures are detailed below for each and every special hazard related to this occupancy. Related recommendations are also mentioned "(see. Rec)". Please refer to Section 11. "Support for Loss Prevention Recommendations" for details

2.1. Green Coke Storage & Handling

- "Green Petroleum Coke" or Raw Petroleum Coke (RPC) Physical Properties:
 - According to some Material Safety Data Sheets.
 - Used as fuel (pulverized inside the combustion chamber in the kiln or boiler)
 - Flashpoint: >93°C (200°F) [Open Cup] / No specific fire or explosion hazard
 - Other MSDSs mention the following:
 - May release flammable gases
 - Fire hazard: is a flammable solid. Vapors may cause fire/explosion if a source of ignition is present
 - Explosion hazard: risk of explosion if heated in a confined system
 - Combustion generates carbon oxides (CO and CO₂), nitrogen oxides (NO_x), hydrogen sulfide, hydrocarbons
- A conveyor belt (covered, inclined, elevated) network is used, travelling from the unloading area to the storage and process units.



Courtesy of Aluminium Bahrain B.S.C. (Alba) – Calcination Plant

Prevention & Protection:

- Control of ignition sources
- Adequate compaction of green coke in the storage area (well ventilated, preventing vapor accumulation)
- Adequate dust control and removal
- Rubber belt conveyors should be protected as per section 11



2.2. Rotary Kiln / Afterburner

- Potential incomplete combustion and explosion of gas accumulating in the combustion chamber.

Prevention & Protection:

- Adequate Safety Combustion Control should be provided, as per Section 11.

2.3. Utilities

Electric Room / Motor Control Centers:

- Fire hazards in electrical or control equipment rooms.

Prevention & Protection:

- An asset integrity program for electrical equipment can help prevent electrical breakdowns that could result in ignition of electrical equipment.
- Adequate fire protection for substations / electric rooms, MCC rooms and oil-filled transformers should be provided, as per Section 11.

Fuel Gas supply:

- Fuel supply is key. Burners can be dual-fired (fuel oil / CNG/ pulverized green coke)
- Gas metering / delivery / pressure reduction & filtration station on site

Prevention & Protection:

- Dual fuel oil / CNG / pulverized green coke gas-fired furnaces are preferred providing a full backup of fuel. An adequate buffer storage of fuel oil supply should be provided.
- Gas ducts, well separated from the grid, also provide adequate back up.
- Gas metering / delivery / pressure reduction stations should be equipped with intrinsically safe electrics (ATEX) and piping should be protected against mechanical impacts (e.g. vehicles).

Fume & Dust Treatment:

- Fume Treatment is very critical for the treating of fumes & dust issued from the fume & dust exhaust system (including the Electro-Static Precipitator – ESP - of the kiln). As per legal requirements (environmental considerations), the Calcination Plant may not be able to operate without a Fume & Dust Treatment system.

Prevention & Protection:

- Redundancies of key equipment (dual PLCs in different fire areas) and spare capacity should be provided for the Fume & Dust Treatment system.
- The electrical room, as well as the oil-filled transformers (i.e. oil-filled transformers at the top of the ESP) should be protected, as recommended in Section 11.



2.4. Control System

- A relatively high level of automation is usually observed for such occupancies (low margin requiring high efficiency). As a result, the Control System may be highly critical (for economic sustainability).

Prevention & Protection:

- Depending on the arrangement, Cyber security and a so-called “data recovery plan” for IT (i.e. loss of data) should be considered.
- Server rooms: when redundant servers are provided, they should be located in different areas. If only one server is provided, a Contingency Plan and an adequate automatic fire protection system should be provided (See Rec. for electric rooms).

2.5. Spare Parts Warehouse

- Critical and very expensive spares are usually stored in one or more warehouses. Heavy spares and consumables are usually well separated. The inventory can represent several Million USD (e.g. \$20-40-60-80M or more).
- These spares are critical to the process and can have a relatively long lead time. Some consumables used in relatively large quantities and/or having a long lead time are also deemed as critical. A major loss in such a warehouse could lead to BI for the related units due to lack of replacement parts/spares.

Prevention & Protection:

- Critical spares should be clearly identified. The commodity class should be clearly established as per NFPA and the warehouse should be provided with adequate and approved automatic fire detection / protection, as per Section 11.
- Flammable and combustible liquids and spray cans should not be stored in such warehouses but, rather, stored in a dedicated safe area. Hazmat and compressed gases should be stored and protected, in accordance with Section 11.

3. CONTINGENCY / BUSINESS CONTINUITY / RECOVERY PLAN

Warning: in order to be reliable, Contingency / Business Continuity / Recovery Plans should be formalized. This would include formal contracts established in advance with vendors or third parties. The plans should be regularly tested, reviewed, and updated.

Holistic view:

- If the Calcination Plant is part of group with a relatively high level of vertical integration in the aluminum industry, a Business Continuity Plan (BCP) at corporate level should be developed for the main identified risks for each and every process unit.
- The impact of a loss impacting thirds parties (i.e. logistics, utilities) should be investigated and an adequate BCP should be established.

Site view:

- **Electrical power:** full backup for electric power supply is preferred. This could consist of two feeders from different substations fed from a national grid loop or one feeder from the national grid backed up by a Captive Power Plant (in case the CRU is part of a complex).
- **Raw Material Supply:** Identify and sign contracts with alternate suppliers.



4. LOSS ESTIMATES

Maximum Possible Loss (Technical MPL – SCOR):

- Scenario: Incomplete combustion and explosion of gas accumulating in the combustion chamber. Total loss of the rotary kiln including the cyclone tower and auxiliary equipment. Potential damage to the nearest kiln(s) (if any) when the separating distance is less than 25m or 40 m depending on the percentage of unprotected openings (i.e. 10%) on the separating wall.
- **MPL PD:** Total loss of the rotary kiln including the cyclone tower and auxiliary equipment. Potential damage to the nearest kiln(s) (if any) when the separating distance is less than 25 or 40 m depending on the percentage of unprotected openings (i.e 10%) on the separating wall.
- **MPL BI:** 18-24 months.
- **Induced BI** should be considered if there are any interdependencies with sister plants upstream and/or downstream. This could be mitigated by buffer storage (providing some extra days of production) and an alternate supplier (if any).

Probable Maximum Loss (Market definition): same as MPL

Note that in terms of loss estimates at SCOR only MPL and NLE are considered. There is no leeway for using any other acronym or definition (i.e. EML, PML, etc.). EML or PML are only given for information.

Normal Loss Expectancy (NLE – SCOR):

- Fire starting on a conveyor or in an electric room.
- **MPL PD:** Limited to the unit protected by the fixed automatic system such as a sprinkler. Total loss if no fixed fire protection.
- **MPL BI:** up to 4 months.
- Induced BI should be considered if there are any interdependencies with sister plants upstream and/or downstream. This could be mitigated by buffer storage (providing some extra days of production) and an alternate supplier (if any).



IX - IMPORT / EXPORT FACILITIES FOCUS

1. PROCESS

Import and export facilities may be different (e.g. marine terminals, inland hubs) from one aluminum facility to another. However, considering the large volume of Raw Materials, the heavy weight of Finished Products and the international orientation of the market, seaports are used for import / export activities. This section is therefore focused on “Ports” / “Marine Areas”. Note that raw materials in large volumes (e.g. bulk bauxite, alumina) are either directly downloaded from Panamax / Capsize-type bulk carriers transporting commodity raw materials, or from transshipping barges with the bulk carriers staying out in the open sea (with the assistance of tugs usually required for accessing channels).



Marine terminal for bauxite export

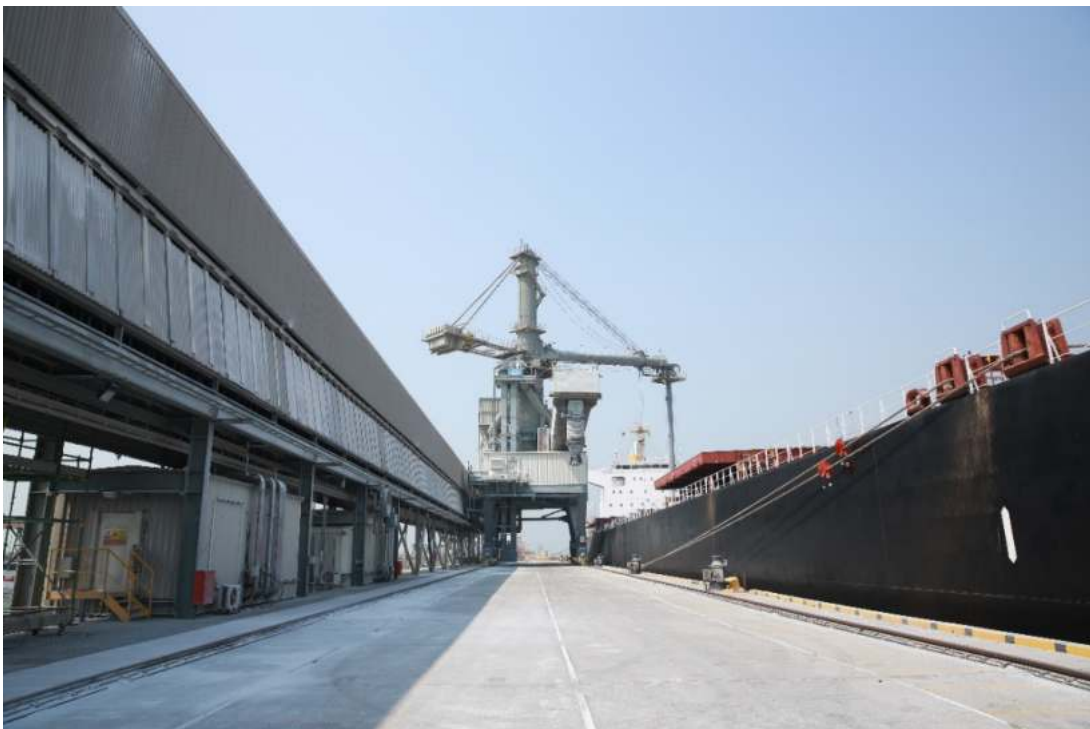

Marine Area

Courtesy of Aluminium Bahrain B.S.C. (Alba)



The following Raw Materials are either imported or exported:

- Bauxite (from Bauxite Mine to Alumina Refinery)
- Alumina (from Refinery to Smelter)
- Cryolite (for Smelter - Reduction Plant)
- Aluminum scrap (for Smelter - Cast House, Re-cycling units, Rolling Mill and Aluminum Downstream)
- Alloying tablets, additives including Magnesium, Copper, Titanium (for Smelter - Cast House and Aluminum Downstream)
- Aluminum ingots / slabs, sows, billets (for Aluminum Downstream)
- Aluminum hot/cold coils (for other Aluminum Downstream and final customers)
- Caustic soda, lime (for Refinery)
- Calcinated Pet Coke (CPC), Liquid Pitch (for Smelter- Carbon Plant)
- Anodes (for Smelter - Reduction Plant)
- Green coke (for Calcination Plant)

Ports may include the following load-handling and storage facilities:

- Liquid Pitch Tanks
- Ship loaders / unloaders
- Alumina silos
- Calcinated Pet Coke silos
- Rubber belt conveyor networks



Alumina silos
Courtesy of SOHAR Aluminium LLC



2. SPECIAL HAZARDS & RISK CONTROL

Special hazards, prevention, protection and potential mitigation measures are detailed below for each and every special hazard related to this occupancy. Related recommendations are also mentioned “(see. Rec)”. Please refer to Section 11. “Support for Loss Prevention Recommendations” for details.

2.1. Ship Loader / Unloader

- A typical electric-driven unloader for alumina (5 days for unloading a ship) and coke (2 days for unloading a ship) may be using:
 - A suction-type system
 - two booms and 2 blower aggregates inside the unloader
 - transformers and MCC equipment



Coke & Alumina unloader
Courtesy of SOHAR Aluminium LLC

Prevention & Protection:

- In case of a major power outage, the electric-driven unloader would not be able to be operated. As a result, one or both booms could be trapped in the bottom of a ship and lift up during high tides. This would result in severe damage to the unloader (an expensive piece of equipment) and potential BI due to the loss of unloading capabilities.
 - A similar case was recorded during the 2010 EQ in Chile: An electric-driven unloader unit on the port lost power during the EQ. Considering the tsunami hazard, the ship captain decided to pilot the ship back out to the open sea. However, the loading arm of the crane was trapped in the ship at that time (no back-up power for the electric drivers). This resulted in severe damages to the unloader.
 - The conclusions drawn are that a Diesel Engine-Driven Generator (tested once a week for 30 minutes) should be available for the ship loader / unloader (an in-built plug is usually provided at the base of the ship loader / unloader).
 - Should the port have two independent feeds (e.g. one from a Captive Power Plant and one from the National Grid), this could be an adequate back-up power supply redundancy. However, all feeders mentioned above supply the same substation at the port and, thus, represent a single point of failure. An independent emergency power generator as recommended will provide adequate and **reliable** backup.



- Prefer a dry-type transformer and dry-type MCC equipment
- Have spares available for critical equipment (e.g. lower aggregates)

2.2. Storage Facilities

- Liquid pitch is used and stored in its liquid state at temperatures between 160 and 190°C (320 and 375°F). Solid pitch is normally not used any more (due to environmental regulations and high safety hazards).



Pitch Tank – Adequately spaced and protected
Courtesy of SOHAR Aluminium LLC

- The above storage includes HTF/M (Heat Thermal Fluid/Media) boiler(s) and loops (e.g. Therminol 66, Fp°170-184, which can be operated over a flashpoint at about 200°C, max. 250°C).
- The HTM (Heat Transfer Media/Fluid) facility consists of tanks of heating fluid (Therminol 66), electric heaters(usually) and expansion tanks.

Prevention & Protection:

- Liquid pitch tank(s) should be located in a secondary containment area able to house 100% of the tank(s) plus 20% for fire water. Monitors should be provided around the tank(s).
- In case of mutual exposures of tanks, adequate cooling rings should be provided. See Section 11 for Ignitable Liquid Storage Tank protection. The provision of nitrogen blankets on the pitch tank is optional.
- The HTM system should be provided with adequate interlocks and fire protection, as recommended in Section 11;



2.3. Rubber Belt Conveyor

- Inclined, elevated, overhead conveyors running from the ship loader / unloader to the silos via junction tower(s).



Overhead Conveyor – sprinkler-protected
Courtesy of SOHAR Aluminium LLC

Prevention & Protection:

- Conveyors should be provided with adequate interlocks and fire protection, as recommended in Section 11.

2.4. Utilities

Electric Room / Motor Control Centers:

- Fire hazards in electrical or equipment control rooms.

Prevention & Protection:

- An asset integrity program for electrical equipment can help prevent electrical breakdowns that could result in the ignition of electrical equipment.
- Adequate fire protection for substations / electric rooms, MCC rooms and oil-filled transformers should be provided, as per Section 11.



Well segregated & sprinkler-protected transformers
Courtesy of Aluminium Bahrain B.S.C. (Alba)

2.5. Control System

- Relatively low level of automation.

Prevention & Protection:

- Depending on the arrangement, Cyber security and a so-called “data recovery plan” for IT (i.e. loss of data) should be considered.
- Server rooms: when redundant servers are provided, they should be located in different areas. If only one server is provided, a Contingency Plan and adequate automatic fire protection system should be provided (See Rec. for electric rooms).

3. CONTINGENCY / BUSINESS CONTINUITY / RECOVERY PLAN

Warning: in order to be reliable, Contingency / Business Continuity / Recovery Plans should be formalized. This would include formal contracts established in advance with vendors or third parties. The plans should be regularly tested, reviewed and updated.

Holistic view:

- If the Port is part of a group with a relatively high level of vertical integration in the aluminum industry, a Business Continuity Plan (BCP) at corporate level should be developed for the main identified risks (e.g. sunken vessels, loss of ship loader / unloader, fire on conveyor, substations) for each and every process units.
- The impact of a loss impacting thirds parties (i.e. logistics, utilities) should be investigated and an adequate BCP should be established.
- The use of an alternate Port and organizing alternate ground transportation should be investigated & incorporated into the BCP.



Site view:

- Electrical power: full backup for electric power supply is preferred. This could consist of two feeders from different substations fed from a national grid loop or one feeder from the national grid backed up by a Captive Power Plant (in case the Port is part of a complex). An independent emergency power generator is recommended for the ship loader / unloader (see above).
- Port Blockage: have a contract with a recognized, specialized ship recovery company. Delays and durations should be defined. In the mean-time, an alternate port should be identified (possessing adequate loading / unloading equipment) and ground transportation should be secured (this may include heavy vehicles over relatively long distances and be subject to clearance from authorities. Third party liability exposure should also be investigated).

4. LOSS ESTIMATES

Maximum Possible Loss (Technical MPL – SCOR):

- Scenario: Tsunami.
- **MPL PD:** Port severely damaged.
- **MPL BI:** 12-18 months
- Induced BI should be considered if there are any interdependencies with sister plants upstream and/or downstream. This could be mitigated by buffer storage (providing some extra days of production) and an alternate supplier (if any).

- Other scenario: Sunken vessel in access chanel or impact on jetty with only 1 single access point.
- **MPL PD:** Port Blockage.
- **MPL BI:** 12-18 months
- Induced BI should be considered if there are any interdependencies with sister plants upstream and/or downstream. This could be mitigated by buffer storage (providing some extra days of production) and an alternate supplier (if any).

- Other scenario: Collapse or major fire on the Ship Loader / Unloader (see above).
- **MPL PD:** Total loss of the ship loader / unloader.
- **MPL BI:** 18-24 months
- Induced BI should be considered if there are any interdependencies with sister plants upstream and/or downstream. This could be mitigated by buffer storage (providing some extra days of production) and an alternate supplier (if any).

Probable Maximum Loss (Market definition): N/A

Note that in terms of loss estimates at SCOR only MPL and NLE are considered. There is no leeway for using any other acronym or definition (i.e. EML, PML, etc.). EML or PML are only given for information.

Normal Loss Expectancy (NLE – SCOR):

- Major fire starting on the conveyor or in the electric room.
- **MPL PD:** Limited to the protected unit. Total loss when no fixed fire protection.
- **MPL BI:** up to 4 months.
- Induced BI should be considered if there are any interdependencies with sister plants upstream and/or downstream. This could be mitigated by buffer storage (providing some extra days of production) and an alternate supplier (if any).



X - UTILITIES (POWER / WATER) FOCUS

1. PROCESS

This section is limited to Electric Power and Water Supply.

Utilities such as Captive Power Plants / Desalination Plants can be dedicated to a Smelter as part of the so-called “Shared Services” for an aluminum complex including (but not limited to): a Port, Refinery, Smelter, Rolling Mill, Recycling Plant and even a Calcination Plant.

Electric Power:

A large quantity of electrical energy is required to operate an aluminum complex.

Modern smelters require secure systems for electrical supply whether from in-house generation (i.e. a Captive Power Plant) or from a Utility Provider (i.e. a private generation plant or national grid electrical high-voltage utility distribution network).

Supply must be secured in terms of capacity, reliability and availability and these factors must be closely studied when a smelter is to be constructed or expanded.

Water:

- A Desalination plant can consist of:
 - Distillation (e.g. 43,000 cum/D. Process heat (off-gas) recovered from the calcination process of the Calcination Plant – see dedicated section above)
 - A Reverse Osmosis Plant (electric pumps pushing sea water through membranes)
 - A water supply network for an intended usage (e.g. process, domestic, firefighting)



2. SPECIAL HAZARDS & RISK CONTROL

Special hazards, prevention, protection and potential mitigation measures are detailed below for each and every special hazard related to this occupancy. Related recommendations are also mentioned “(see. Rec)”. Please refer to Section 11. “Support for Loss Prevention Recommendations” for details.

2.1. Captive Power Plant

A Captive Power Plant may consist of one or more of the following:

- A coal/gas/fuel oil/pet coke/waste-fired power plant (boilers and steam turbine)
- A combined cycle (Gas Turbines, Heat Recovery Steam Boiler and Steam Turbines) that may be operated as an open cycle (GTs only) using gas and or distillates (back up)
- Renewable energy, including (or not) energy storage



Special hazards include (but are not limited to):

- Rubber belt conveyors
- Turbines
- Generators (air / hydrogen cooled)
- Hydraulic lubrication groups
- Oil-filled transformers
- Electric rooms
- Cooling towers



Captive Power Plant
Courtesy of SOHAR Aluminium LLC



Power Station 5
Courtesy of Aluminium Bahrain B.S.C. (Alba)



Prevention & Protection:

- There should be an adequate maintenance & inspection program (e.g. IR scanning, DGA, overhaul) including technical agreements with OEMs.
- On-line DGAs should be considered for all main transformers (i.e. Power Plant generator transformers, main auxiliary transformers).
- Critical spares should be identified and stored on site (e.g. spare rotors for ST/GT).
- All above-mentioned special hazards (as well as the BSDG) below should be protected, as per Section 11.



Adequate Fire Protection of GTs

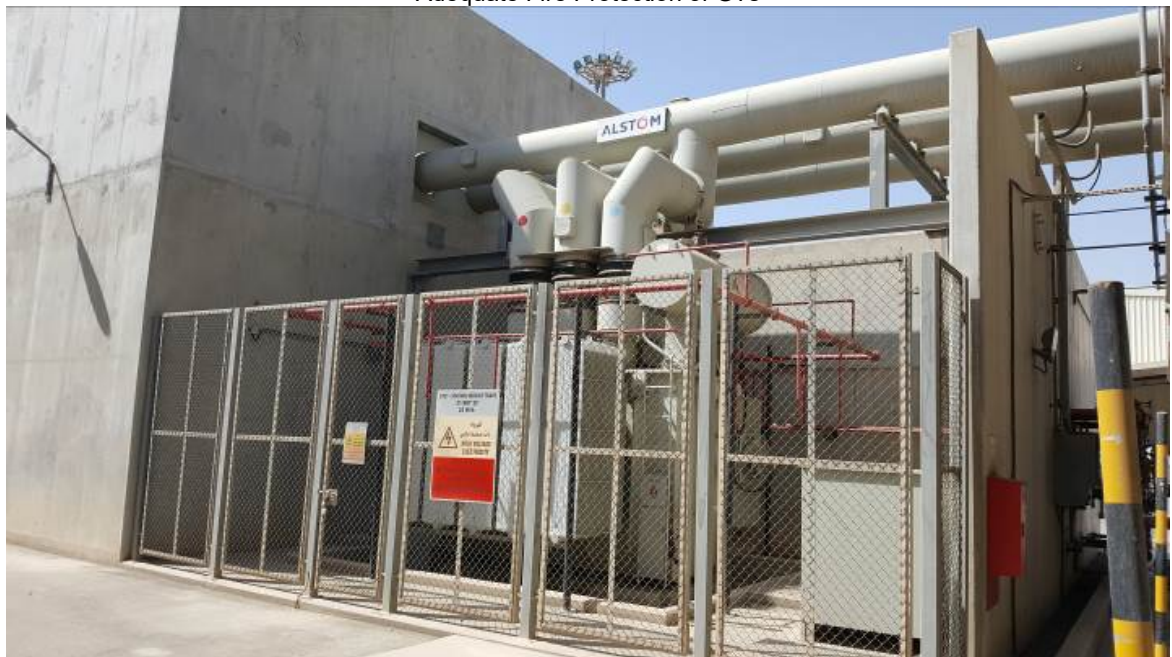

Adequate Segregation & Fire Protection of Oil-Filled Transformers
Courtesy of SOHAR Aluminium LLC

- Spare capacity and backup should be provided to allow for maintenance (N+1) without interrupting the process but also in case of a major loss (N+2) on one unit (e.g. 2



redundant blocks, each block consisting of 2xGTs and 1xST). Seasonal variations (summer / winter) should also be considered.

- Fuel supply should be secured. This could consist of one or more of the following:
 - Dual burners: Fuel Oil / CNG
 - Two fuel gas ducts from different sources (different gas delivery stations)
 - Alternate suppliers for fuel and coal as well as a buffer storage on site
 - Provide High-Pressure gas pipes as backup for the gas compression unit for GTs using only high-pressure fuel gas (should fuel gas compression units fail) or other adequate redundancies and backup for the fuel gas compression units.
- Fuel oil tank(s) should be located in a secondary containment area able to house 100% of the tank(s) plus 20% for fire water. Monitors should be provided around the tank(s). In case of mutual exposures of tanks, adequate cooling rings should be provided. See Section 11 for Ignitable Liquid Storage Tank protection.



Fuel oil tanks adequately spaced and secondary retention provided
Courtesy of SOHAR Aluminium LLC - Captive Power Plant

- Black Start capabilities should be provided for Captive Power Plants. This could consist of:
 - Feeders from the grid
 - Black Start Diesel Generators (BSDG)

2.2. Transmission & Distribution (T&D)

- T&D lines may belong to:
 - The National Grid
 - The Smelter or Aluminum Complex (i.e. Shared Services): e.g. several kms between the Captive Power Plant and the Port and the Smelter.
- High Voltage feeders are usually overhead lines installed on pylons.

Prevention & Protection:

- Prefer multiple feeders from different substations located in different areas (avoiding one single point of failure: e.g. fire, flood, tsunami on a coastal area).
- Ensure that the supply lines are separately routed from the Grid / Captive Power Plant to the smelter site, to the maximum extent of what can be practically powered (different and well-spaced pylons). Place the pylons in each line far enough apart to ensure



continuity of supply through one line in case of any physical damage to the pylons of the other.

- Design overhead lines and supporting pylons to resist maximum weather-related loads. Give particular attention to the possible buildup of ice on cables under adverse weather conditions.
- Protect overhead power lines against direct lightning strikes by using ground wires.
- Ensure there is an adequate Maintenance and Inspection program.



2.3. Power Distribution System (PDS)

- Some smelters have been built with a Captive Power Plant (or Power Station) and a connection to the grid providing partial or full backup.
- When a new pot line is built, a Captive Power Plant is also built.
- All power-generating sources are then interconnected (directly or through the Sub-Station / Switch House) in order to provide mutual back up and spare capacity.
- The interconnection is done through a Power Distribution System (PDS) for better reliability (redundancy) and efficiencies (control and regulation).
- The PDS is highly sophisticated, including load-shedding logic sequences in case of any unbalanced situation, in order to protect all power-generating sources.
- As a result of the load-shedding logic sequence, a single event can initiate a cascade of trips in different substations that could culminate in a total power blackout.
- Moreover, if a load-shedding sequence is initiated, the sustainable restoration of the system after blackout can be relatively difficult.



- Example of a PDS - Diagram:

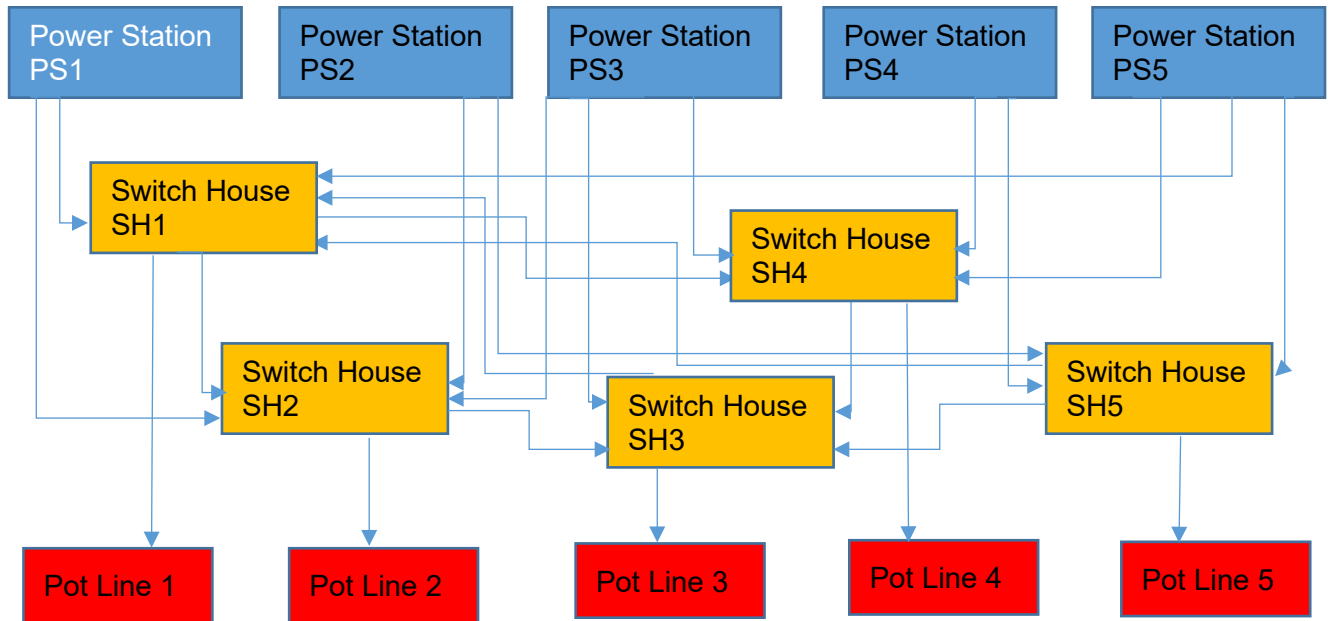

© Didier Schütz - DLS

Prevention & Protection:

- Adaptation of the de-loading logic sequence. This could consist of:
 - Possible interruption of de-loading when the abnormal condition is cleared up
 - De-loading sequence starting on one block only (e.g. 3 GTs and 1 ST) and not 2 blocks at once
- Blackout recovery map in case of blackout. This may include the following steps:
 - Identifying the Cause
 - Isolating the Problem & performing a safe Shutdown
 - Ensuring Gas, Air and Auxiliary Power are available
 - Generating Power
 - Restoring Pot Line Operations

2.4. Desalination Plant

- Sea water intake: potential impact from a ship or contamination of sea water (e.g. crude oil) contaminating the desalination plants downstream.
- Reverse Osmosis Plants include Membranes
- These units include electric rooms, PLCs and oil-filled transformers.

Prevention & Protection:

- Protection of sea water intake from any mechanical impact. Check the quality of sea water regularly. Have an emergency floating dam ready and an emergency procedure in place (including testing).
- Spare membranes should be available and alternate suppliers identified.
- Protect all electric rooms and oil-filled transformers in accordance with Section 11.



2.5. Fume Treatment

- Electrostatic Precipitators
- Oil-filled transformers
- Electric rooms, cable trays

Prevention & Protection:

- Electrostatic Precipitators: once a fire is detected, the unit should go into emergency shutdown immediately. It should be recognized that during operations, the atmosphere in the precipitator is oxygen-deficient and opening doors or running system fans following a fuel trip could cause conditions to worsen (increased potential for a backdraft explosion). Once the flow of air and fuel to the fire has been stopped and the electrostatic precipitator has been shut down and de-energized, the precipitator doors can be permitted to open and water hoses may then be deployed, if necessary. (See NFPA850).
- Oil-filled transformers (including the Electrostatic Precipitator's transformer) should be protected, as per Section 11.
- Electrical rooms and cable openings should be protected, as per Section 11.

2.6. Control System

- High level of automation and monitoring systems. (See PDS above).

Prevention & Protection:

- Depending on the arrangement, Cyber security and a so-called "data recovery plan" for IT (i.e. loss of data) should be considered.
- Server rooms: when redundant servers are provided, they should be located in different areas. If only one server is provided, a Contingency Plan and adequate automatic fire protection system should be provided (See Rec. for electric rooms).

2.7. Spare Parts Warehouse

- Critical and very expensive spares (i.e. spare rotors for a GT/ST) are usually stored in one or more warehouses. Heavy spares and consumables are usually well separated. The inventory can represent several Million USD (e.g. \$20-40-60-80M or more).
- These spares are critical to the process and can have a relatively long lead time. Some consumables used in relatively large quantities and/or having a long lead time are also deemed as critical. A major loss in such a warehouse could lead to BI for the related units due to lack of spares.

Prevention & Protection:

- Critical spares should be clearly identified. The commodity class should be clearly established as per NFPA, and the warehouse should be provided with adequate and approved automatic fire detection / protection, as per Section 11.
- Flammable and combustible liquids and spray cans should not be stored in such warehouses but, rather, in a dedicated safe area. Hazmat and compressed gases should be stored and protected, in accordance with Section 11.

3. CONTINGENCY / BUSINESS CONTINUITY / RECOVERY PLAN

Warning: in order to be reliable, Contingency / Business Continuity / Recovery Plans should be formalized. This would include formal contracts established in advance with vendors or third parties. The plans should be regularly tested, reviewed and updated.



Holistic view:

- If the power generation (e.g. Captive Power Plant) is part of a group with a relatively high level of vertical integration in the aluminum industry, a Business Continuity Plan (BCP) at corporate level should be developed for the main identified risks for each and every process unit.
- The impact of a loss impacting third parties (i.e. logistics, utilities) should be investigated and an adequate BCP should be established.

Site view:

- **Electrical power:** Ensure there is a robust power supply including redundancies and spare capacity. This could include, in order of preference:
 1. Having a Captive Power Plant (combined cycle GTs/STGs) and full backup by the national grid.
 2. Having several Captive Power Plants (i.e. different pot line power supplies) with spare capacity and some backup from the grid, providing full backup.
 3. Having feeders that are well separated from the different substations and from the grid (loop arrangement), with 100% back-up capacity.

Note that regardless of how robust the power supply from a capacity and redundancy standpoint may be, in most cases there is just one **single point of failure** that may lead to a total power outage. This single point of failure could be caused by the following situations:

- All power supplies linked to the same substation (*) feeding the aluminum complex (spur arrangement or 'dead end', instead of 2 well separated substations organized on a loop)
- Redundant power lines (i.e. N+2) installed on different pylons but exposing each other (i.e. lack of clearance).
- Power supplies severely exposed to Nat Cat (i.e. EQ, Tsunami, Ice Storm) that may impact the entire power supply.

(*) Some Risk Managers may propose a Business Continuity Management (BCM) plan for bypassing - using jumper cables - the single substation which is used basically for protection between the grid and the aluminum complex. As a result, the aluminum complex would be powered from the grid without protection. The feasibility, process, equipment needed and time required (considering 4-5hr max. allowed before pot freeze) for installing this bypass should be investigated and documented. Moreover, even if technically possible, some authorities-having-jurisdiction may not permit feeding the aluminum complex from the grid without protection.

As a result of the above, all single points of failure should be identified and adequate alternatives considered. This could include the duplication of some facilities in different fire areas and/or natural peril areas (e.g. flood, tsunami in coastal areas).

- **Water:** An alternate water supply should be provided. There could be a duplication of the desalination plant located in different fire and natural peril areas (e.g. flood, tsunami in coastal areas) with sufficient spare capacity providing full backup.

4. LOSS HISTORY

4.1. Loss at Smelter due to Service Interruption

- About 50% of the losses occurring at smelters powered by an external supplier (power plant or national grid) were the result of power transmission lines damaged by ice/wind, ice, and maintenance.
- About 50% of the losses occurring at smelters powered by Captive Power Plants were due to faulty operations of the switchgear, generator tips (instabilities) and lightning voltage surges.



4.2. Cooling Tower Fire

2012: Seawater cooling tower for the steam turbines of a combined cycle power plant. Total loss of the cooling tower:

Circumstances: the cooling tower was supplied as a kit of parts and assembled by a contractor (and sub-contractors). A number of issues arose from the construction and early operations of the cooling tower. These problems required modifications being made to the tower by the contractor, some of which were still on-going at the time of the fire. These included a problem of structural vibration that appears to have been caused by incorrect tightening of the bolts that connect the parts of the tower frame. At the time of the fire, some cells were not operating.

Main possible causes of the fire considered: an electrical fault, actions during work by contractors in the days before the fire, frictional heating or a deliberate act. However, there was no hard evidence and the investigations were inconclusive.

More than USD 25M was needed to rebuild the cooling tower. Extra costs were incurred as electric power had to be purchased from the national grid.

5. LOSS ESTIMATES

Maximum Possible Loss (Technical MPL – SCOR):

- Scenario: A major man-made event (e.g. explosion due to the disintegration of GTs/STs, a fire on a substation constituting a single point of failure) or a natural peril event (e.g. tsunami on a coastal area destroying the Captive Power Plant).
- **MPL PD:** Loss of GTs/STs up to the total loss of the Captive Power Plant in the case of a natural peril.
- **MPL BI:** up to 18 months.
- Induced BI should be considered if there are any interdependencies with sister plants upstream and/or downstream (i.e. pot freeze at the smelter). This could be mitigated by buffer storage (providing some extra days of production) and an alternate supplier (if any).

Probable Maximum Loss (Market definition): N/A

Note that in terms of loss estimates at SCOR only MPL and NLE are considered. There is no leeway for using any other acronym or definition (i.e. EML, PML, etc.). EML or PML are only given for information.

Normal Loss Expectancy (NLE – SCOR):

- A major fire starting on a conveyor (coal) or in an electric room:
- **MPL PD:** Limited to the protected unit. Total loss when no fixed fire protection.
- **MPL BI:** from 3-4 months (substation belonging to a Captive Power Plant) or up to 6-8 months (main substation belonging to the National Grid).
- Induced BI should be considered if there are any interdependencies with sister plants upstream and/or downstream (i.e. pot freeze at the smelter). This could be mitigated by buffer storage (providing some extra days of production) and an alternate supplier (if any).



XI - SUPPORT FOR LOSS PREVENTION RECOMMENDATIONS

The following recommendations apply for the special hazards mentioned in the previous sections:

1. CAPTIVE POWER PLANT – GAS TURBINE

Adequate, reliable and approved fire protection systems should be installed to protect the gas turbine generator as well as the lubrication oil group. The systems should take guidance from the recommended practices of “NFPA 850 Recommended Practice for Fire Protection for Electric Generating Plants and High Voltage Direct Current Converter Stations, 2020 Edition” or FM Global Data Sheets 7-79 “Fire Protection for Gas Turbines and Electric Generators”, with some additional remarks:

- Provide fixed automatic fire protection for the insides of turbine and generator compartments, as well as enclosures for auxiliary equipment such as fuel skids and lubrication fluid pumping and conditioning equipment, load compartments, exciter compartments and other enclosures containing oil fire hazards. This may consist of one of the following FM -approved automatic fire protection systems:
 - a) FM-approved inert gas or carbon dioxide (CO₂) system.
 - b) Total flooding water mist system, FM-approved, for the protection of gas turbines or machinery in enclosures, as applicable.
 - c) Hybrid (water and inert gas) system, FM-approved, for the protection of gas turbines or machinery in enclosures, as applicable.
 - d) Where fuel, lubrication, and hydraulic oil tanks, pumps, or other equipment not subject to potential water damage is located inside a dedicated room or an enclosure, adequate automatic sprinkler protection may be provided as an alternative to options a, b, and c above. Do not provide this option for gas turbine enclosures.

2. CAPTIVE POWER PLANT - STEAM TURBINE

With the invaluable and kind support of Frank Orset, Loss Prevention Engineer:

Inadequate fire-protection systems and a lack of proper emergency protocols can lead to serious damage and extended outages in the event of a lube-oil fire in a turbine hall.

Oil releases of pressurized-oil systems used in bearing lubrication, seal oil, hydraulics or control systems are most often caused by electrical failure, fitting failures, operator error or vibration. This may cause a spray fire, a pool fire or a three-dimensional spill fire.

Adequate, reliable and approved fire protection systems should be installed to protect the steam turbine generator as well as the lubrication oil group. The systems should take guidance from the recommended practices of “NFPA 850 Recommended Practice for Fire Protection for Electric Generating Plants and High Voltage Direct Current Converter Stations, 2020 Edition” or FM Global Data Sheets 7-101 “Fire Protection for Steam Turbines and Electric Generators”, with some additional remarks:

2.1. Turbine generator operating floor

Turbine generator bearings should be protected with an automatic closed-head sprinkler system utilizing directional nozzles. Automatic actuation is more reliable than manual actuation. Fire protection systems for turbine generator bearings should be designed for a density of 10.2 mm/min (0.25 gpm/ft²) over the protected area of all bearings.

Note that NFPA 804 - Standard for Fire Protection for Advanced Light Water Reactor Electric Generating Plants, 2020 Edition & 805 - Performance-Based Standard for Fire Protection for



Light Water Reactor Electric Generating Plants, 2010 Edition, require a density of 12.2 mm/min (0.3 gpm/sq ft) and Factory Mutual requires a minimum flow of 113 l/min (30 gpm) per nozzle.

This system comprises one to two closed 90-degree directional spray nozzles over each bearing and directed at the shaft seal. The nozzles should be rated at approximately 83°C (150°F) above the highest ambient temperature.

These nozzles should also be located approximately 60 cm (2 ft) from the shaft at the 10 and 2 o'clock positions, thus providing the proper spray pattern, cooling and flushing of any oil spray/leak below the turbine deck.

Additionally, one heat detector rated at approximately 30°C (86°F) above the highest ambient temperature should be installed 60 cm (2 ft) directly above the shaft.

In the case of a fire, the heat released by the fire triggers the heat detectors, which in turn open the valve.

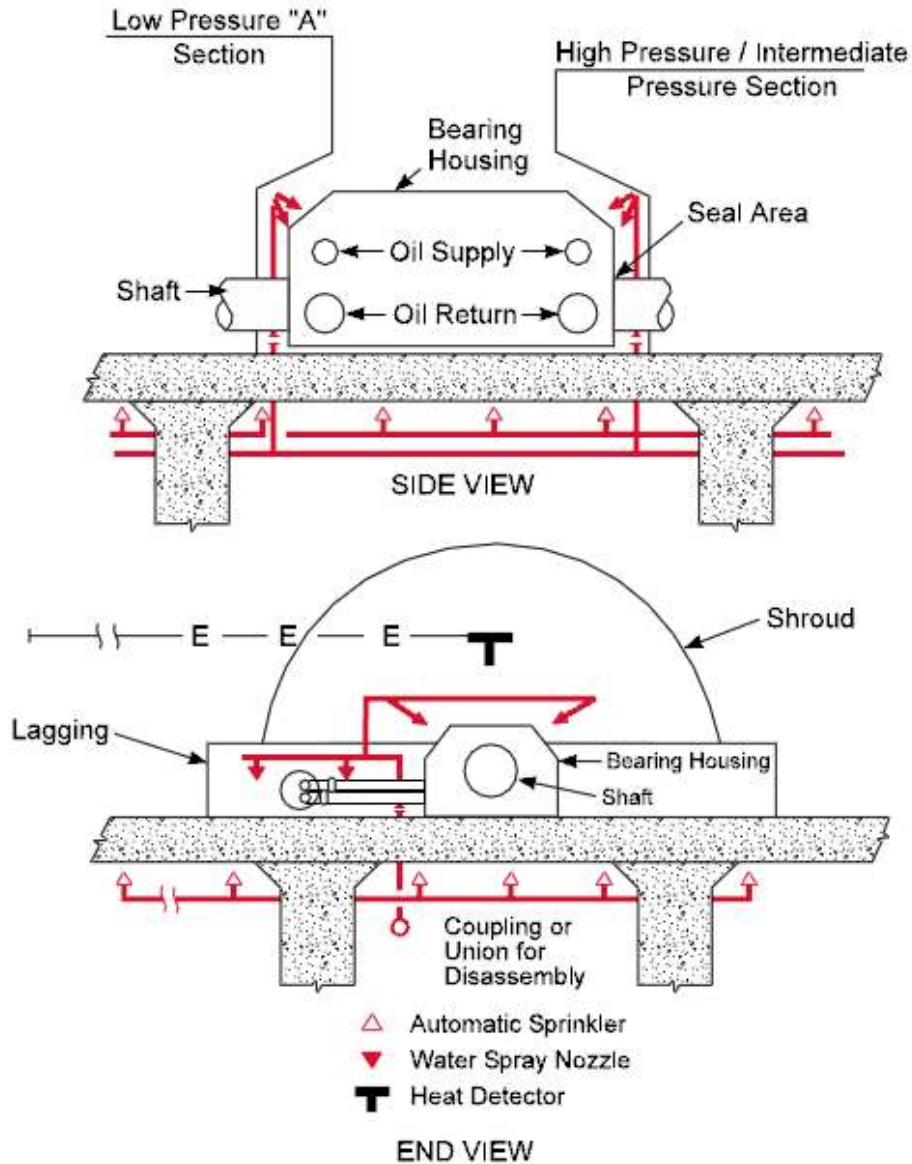

(FM Global Data Sheets 7-101 "Fire Protection for Steam Turbines and Electric Generators")
Posted and reprinted with permission by FM Global. ©2011-2014 Factory Mutual Insurance Company. All rights reserved.



Protection for bearing housing and areas under turbine skirts:

Accidental water discharge on bearing points and hot turbine parts should be considered, hence a pre-action system, as said above, is recommended. If necessary, these areas can, in addition, be protected by shields and encasing insulation with metal covers.

If turbine generator bearings are protected with a manually operated sprinkler system, the following should be provided:

- Manual activation should be from the control room or a readily accessible location not exposing the operator to the fire condition. Plant personnel should be sufficiently trained to promptly handle this function as well as other responsibilities during an emergency of this nature.
- Automatic fire detection should be provided over the area of each bearing and within the skirting of the turbine where a potential for oil to pool can alert operators to a fire condition.
- Documented procedures should be in place with authority given to operators to activate the system, if necessary, in a fire condition.
- Periodic training should be given to operators regarding the need for prompt operation of the system.
- Regular inspection of the sprinkler & detection system should be conducted to ensure proper functionality at all times.

Automatically actuated systems have proven to actuate properly under fire conditions and are not prone to spurious actuation. If a manually operated water system is installed, consideration should be given to a supplemental automatic gaseous fire extinguishing system

The decision for the installation of fire protection systems subject to accidental water discharge on the turbine generator bearings and hot turbine parts must be a local management decision. Alternatives should consist of the use of special fire protection gaseous agents in accordance with NFPA / FM Standards.

All areas beneath the turbine generator operating floor that are subject to oil flow, oil spray or oil accumulation should be protected by an automatic sprinkler or a foam-water sprinkler system. This coverage normally includes all areas beneath the operating floor in the turbine building.

The sprinkler system beneath the turbine generator should take into consideration obstructions from structural members and piping, and should be designed to deliver a density of 12.2 mm/min (0.3 gpm/sq ft) over a minimum application of 465 m² (5000 sq ft) with standard spray sprinkler heads preferably rated at 141°C (286°F) (K115 (K8.0)) for a roof height up to 4.5 m (15 ft).

If there is no intermediate protection below the mezzanine or over areas with a pool fire hazard, for a roof height between 4.5 and 9 m (15 and 30 ft), the sprinkler system should be designed to deliver a density of 16 mm/min (0.4 gpm/sq ft) over a minimum application of 465 m² (5000 sq ft) with standard spray sprinkler heads preferably rated at 141°C (286°F) (K160 (K11.2)).

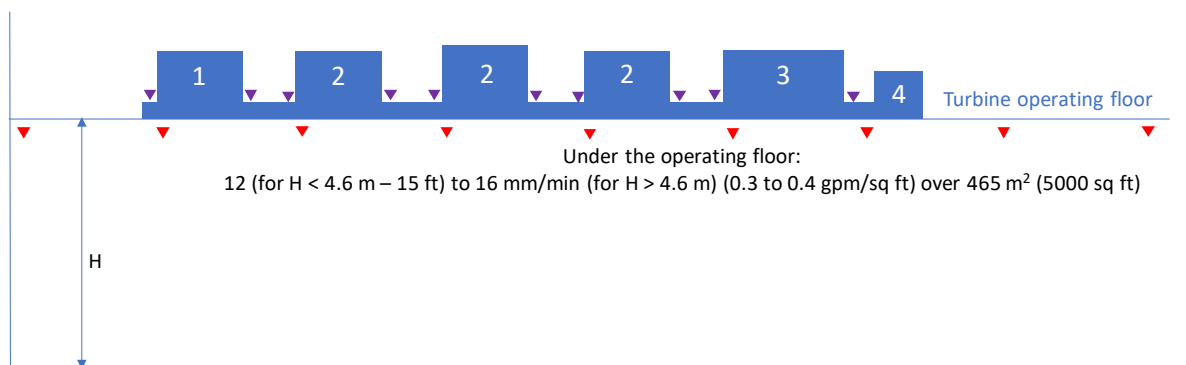

Sprinkler protection with no intermediate levels

Posted and reprinted with permission of FM Global. ©2011-2014 Factory Mutual Insurance Company. All rights reserved.



When grated mezzanines are provided below the operating floor, additional sprinkler protection should be provided below, as well as at intermediate levels where oil spills are liable to accumulate.

The sprinkler system beneath the turbine generator should take into consideration obstructions from structural members and piping, and should be designed to deliver a density of 12.2 mm/min (0.3 gpm/sq ft) over a minimum application of 465 m² (5000 sq ft) with standard spray sprinkler heads preferably rated at 141°C (286°F) (K115 (K8.0)).

The density below the grated mezzanines, depending on the height between the sprinklers and the ground, should be designed the same way as the protection below the operating floor - over 232 m² (2500 sq ft) for the lower mezzanine and 12.2 mm/min (0.3 gpm/sq ft) over 140 m² (1500 sq ft) for the intermediate levels.

The temperature rating of the sprinkler heads below the mezzanines can be ordinary or high.

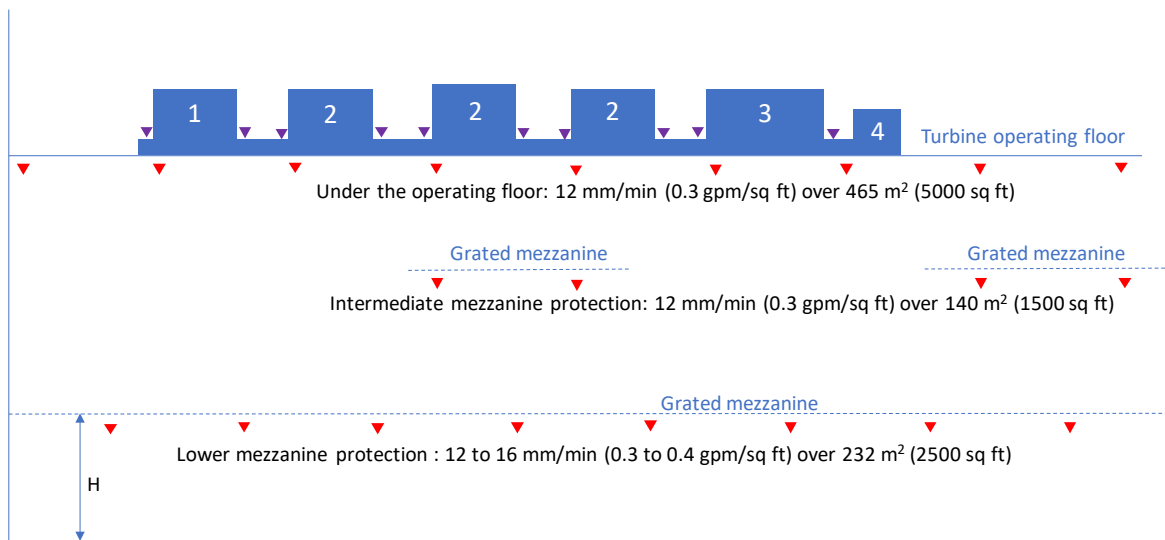

Sprinkler protection with grated mezzanines

Posted and reprinted with permission of FM Global. ©2011-2014 Factory Mutual Insurance Company. All rights reserved.

Lubricating oil lines above the turbine operating floor should be protected with an automatic sprinkler system covering those areas subject to oil accumulation, including the area within the turbine lagging (skirt).

The automatic sprinkler system should be designed to deliver a density of 12.2 mm/min (0.3 gpm/sq ft) with standard spray sprinkler heads preferably rated at 141°C 286°F (K115 (K8.0)).

2.2. The lubrication group

Lubricating oil reservoirs and handling equipment should be protected by an automatic sprinkler or foam-water sprinkler system.

The sprinkler system should take into consideration obstructions from structural members and piping, and should be designed to deliver a density of 12.2 mm/min (0.3 gpm/sq ft) over a minimum application of 465 m² (5000 sq ft) with standard spray sprinkler heads preferably rated at 141°C (286°F) (K115 (K8.0)).

If the lube oil reservoir is elevated, the sprinkler protection should be extended to protect the area beneath the reservoir.

Note:

In some particular circumstances, there is no ceiling above the lube oil tanks and there is no technical possibility to provide a reliable way of collecting the convective heat plume at the sprinkler head position.

In these situations, the above-mentioned protection would not be reliable and should be replaced with the following:



The protection on the lube oil tanks should be based on a deluge system with open sprinkler heads and a designed density of 12 mm/min (0.3 gpm/sq ft) over the entire area of the lube oil tanks.

The system should be activated either by a pilot line (68°C (154°F)-rated sprinkler heads would be preferable, with heat collector plates above the detector heads) or an appropriate fire detection system.

An additional way of manually activating the deluge system from a remote and safe area should be provided (in case the detection system is not working for any reason).

The plant should be designed, and equipment arranged, so that lubricating oils will be confined to a specified area. The use of trenching, curbs, and dikes plus the utilization of natural holding sumps, such as condenser pits, can serve as an aid in accomplishing this requirement.

It is preferable that turbine lube oil storage tanks and reservoirs be cut off from all other areas of the turbine building by fire barriers of 180 minutes fire-resistance.

A properly engineered fixed fire extinguishing system (see above) should be provided throughout all such enclosures.

Where oil storage tanks are not cut off from other areas, they are acceptable provided that:

- they are located in areas where the ceiling is protected by an overhead sprinkler system and the sprinkler protection extends sufficiently over the peripheral areas subject to oil spray and oil flow, to control the heat produced by oil fires and maintain building temperatures below those which cause deformation of the structures
- the tanks are protected by an automatic water spray system
- an oil containment system is installed in accordance with Standards.

To prevent potential damage from the effects of water spray, emergency lube oil pumps should be of the enclosed type with the electrical circuits to the oil pump motors routed and protected so that control will not be impaired by the fire emergency.

Turbine oil reservoirs and lube oil filters, equipped with hinged access panels designed to relieve internal pressure, should have tamper-resistant devices installed so that pressure relief of the tank is rendered possible, e.g. locked cages can be installed over the covers, arranged in such a way that the covers can be raised.

Non-condensable vapor extractors should be vented outdoors.

Cables for operating the lube oil pumps should be protected from fire exposure. Protection can consist of separating the cables for AC and DC oil pumps or 1-hour fire-resistive coatings (derating of cables should be considered).

If the lubricating oil equipment is in a separate room enclosure, protection can be provided by a total-flooding gaseous extinguishing system (e.g. CO₂, designed to deliver a minimum concentration of 34% for at least 20min).

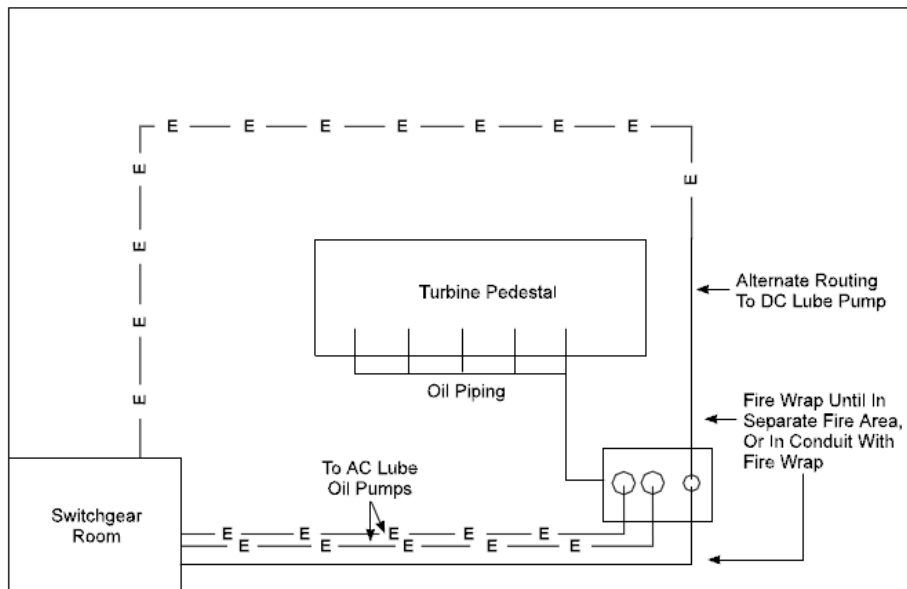

Posted and reprinted with permission of FM Global. ©2011-2014 Factory Mutual Insurance Company. All rights reserved.

2.3. Exciter

The area inside a directly connected exciter housing should be protected with a total-flooding automatic carbon dioxide system, designed to deliver a minimum concentration of 34% for at least 20min (or during the total coast down period of the machine if longer than 20min). The purpose is to protect the bearings inside the exciter housing.

Although the extension of the bearing pre-action water spray system to the exciter enclosure is an acceptable means of fire protection, the installation of an automatic total-flooding carbon dioxide system (CO₂) is preferred over water spray.

When not directly connected, the exciter is not considered as direct exposure to the turbine generator and protection is not required.

2.4. Hydrogen seal oil

Hydrogen seal oil units should be protected by an automatic sprinkler or foam-water sprinkler system.

The sprinkler system should take into consideration obstructions from structural members and piping, and should be designed to deliver a density of 12.2 mm/min (0.3 gpm/sq ft) over a minimum application of 465 m² (5000 sq ft) (or entire area if smaller than 465 m² (5000 sq ft)) with standard spray sprinkler heads preferably rated at 141°C (286°F) (K115 (K8.0)).

The seal oil units should preferably be located in a cut-off fire area. When these systems are not cut off, the sprinkler protection should extend sufficiently into the peripheral areas subject to oil spray and oil flow, to control the heat produced by oil fires and maintain building temperatures below those which cause deformation of the structures.

2.5. Feed water pumps

The sprinkler system should be designed to deliver a density of 12.2 mm/min (0.3 gpm/sq ft) over a minimum application of 465 m² (5000 sq ft) (or entire area if smaller than 465 m² (5000 sq ft)) with standard spray sprinkler heads preferably rated at 141°C (286°F) (K115 (K8.0)).

The feed water pumps should preferably be located in a cut-off fire area or at least provided with fire separation between the different units.



2.6. Oil storage areas / Discharge tank area

Clean or dirty oil storage areas should be protected with a density of 12.2 mm/min (0.3 gpm/sq ft) over a minimum application of 465 m² (5000 sq ft) with standard spray sprinkler heads preferably rated at 141°C (286°F) (K115 (K8.0)).

As this area generally represents the largest concentrated oil storage in the plant, separation, ventilation and drainage should be provided in addition to the automatic protection.

The oil storage tanks should preferably be located in a cut-off fire area.

2.7. Cable concentrations in the Turbine Hall

In addition (if not included in the above-mentioned protection), large concentrations of cable trays below the turbine floor should also be protected by an automatic sprinkler system.

The sprinkler system should be designed to deliver a minimum density of 12.2 mm/min (0.3 gpm/sq ft) over the entire area (with a maximum operating area of 232 m² (2500 sq ft)).

The sprinkler heads should be rated at 68°C (154°F) (K80 (K5.6)).

2.8. Hydrogen

Hydrogen cylinders should be stored outside or in a separate, well-ventilated enclosure.

Indoor storage of hydrogen cylinders should be protected by a sprinkler or water spray system designed to deliver 12.2 mm/min over 232 m² (0.3 gpm/sq ft over 2500 sq ft) with K80 (K5.6) spray sprinklers, preferably rated at 141°C (286°F), or over the entire area if they are water spray systems.

The protection should be extended 6 m (20 ft) beyond the storage area.

An excess flow valve and an emergency shut-off valve should be provided on the supply line where hydrogen is supplied from a large central storage, remote from the building. The emergency shut-off valve should be in a readily accessible location and arranged for remote operating from the control room.

2.9. Emergency hydrogen drainage valve

The generator hydrogen dump valve and hydrogen draining equipment should be arranged to vent directly to a safe outside location. The dump valve should be remotely operated from the Main Control Room and manually from an area accessible during a machine fire (preferably located outside the main building, in an area not exposed by adjacent equipment such as transformers).

2.10. Combustible roof for Turbine Hall building

If the roof of the turbine hall is of combustible construction (either a combustible insulation material such as polyurethane or expanded polystyrene or a non-combustible insulation, such as foam glass, but glued to the roof metal panels with bitumen), it should be replaced with a noncombustible construction system (such as rockwool mechanically fastened on the steel deck assembly) or a sprinkler protection system should be provided.

The minimum designed density for sprinkler protection should be 8 mm/min (0.2 gpm/sq ft) over 465 m² (5000 sq ft) (wet system) or 740 m² (8000 sq ft) (dry system) with 141°C (286°F)-rated spray sprinkler heads.

2.11. Additional specifications

180 m³/h (792 gpm) should be provided for the manual firefighting needs in the turbine hall area (hydrants and hoses). Note that NFPA recommends 113 m³/h (500 gpm), which is also acceptable.

Sprinklers also need to be provided under obstructions wider than 1.2m (4 ft), such as large piping and valves, and under the condenser as this is an area where burning oil can accumulate.



If a mezzanine is present, sprinklers must be provided for each level below the turbine deck.

Lube oil purifiers should be located in an area protected by an overhead sprinkler system and an oil containment system.

Spill containment curbs prevent the pool fire from spreading outside the sprinkler-protected area. Proper drainage to prevent burning oil from being floated to unprotected areas of the plant should be provided for all combustible/flammable-type oil hazards.

Electrical equipment in the area covered by a water or foam-water system should be of the enclosed type or otherwise protected to minimize water damage in the event of the system being triggered.

To extinguish a three-dimensional spray oil fire in the turbine bearing and oil pipe areas, a water spray system with a design water density of 40 to 60 mm/min (1 to 1.5 gpm/sq ft) may be recommended.

Commonly used water spray densities of 12 to 20 mm/min (0.3 to 0.5 gpm/sq ft) will protect and cool machinery and building constructions, but not necessarily extinguish a three-dimensional fire.

The area that should be protected on the operating floor depends on curbing and drainage but should generally be extended to a distance of 6 m (20 ft) around the turbine generator.

The operating temperature of the sprinkler heads should be set 30°C (86°F) above the highest expected ambient temperature.

2.12. Sketch of an automatic protection location overview in a Turbine Hall

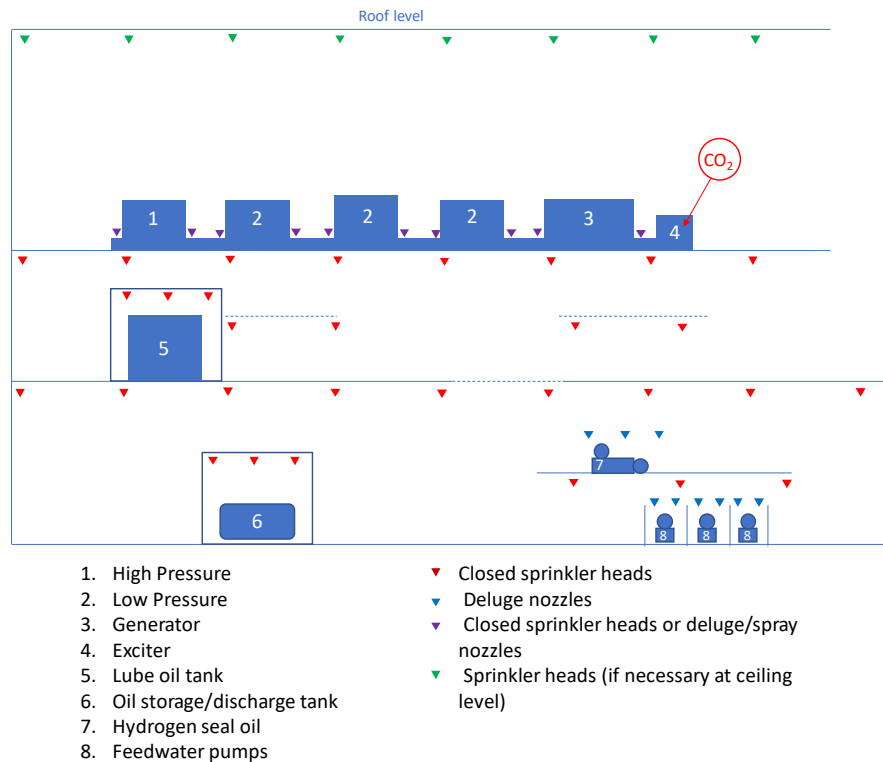

Posted and reprinted with permission of FM Global. ©2011-2014 Factory Mutual Insurance Company. All rights reserved.



3. STATIONARY COMBUSTION ENGINE AND GAS TURBINE

With the invaluable and kind support of Franck Orset (FPO) Loss Prevention Engineer:

All stationary combustion engines such as Diesel Engine-Driven Generators, Diesel Engine-Driven Fire Pumps and Gas Turbines should be provided with the following fire protection, in compliance with NFPA13 and NFPA850.

The preferred choice is a sprinkler system.

Sprinkler and water spray systems:

Sprinkler and water spray protection systems should be designed either:

- for a minimum density of 12.2 mm/min (0.3 gpm/sq ft) over 232 m² (2500 sq ft) with standard spray sprinkler heads preferably rated at 141°C (286°F) (K115 (K8.0)).
- For a minimum density of 10.2 mm/min (0.25 gpm/sq ft) over the entire area for a deluge system.

The maximum area of coverage per sprinkler or nozzle should be 9 m² (100 sq ft).

The sprinkler and water spray system coverage should be extended to all areas in the enclosure located within 6 m (20 ft) of the engine, the lubricating oil system and the fuel system (i.e. the entire room in most configurations).

Gas protection systems:

For gas protection systems, the designed concentration should be maintained for a minimum duration of 20 minutes, or the rundown time of the turbine, or for the time engine surfaces are above the autoignition temperature of the fluid, whichever is greater.

The agent concentration should be determined for the specific combustible material involved (i.e.: 34% in the case of a CO₂ gas protection and a fuel/diesel standby generator).

An extended discharge should be provided to compensate for leakage from the compartment and to maintain an extinguishing concentration for the rundown time of the engine (or 20 minutes).

For the activation of the gas protection system, heat detectors should be provided at the ceiling level of the diesel generator enclosure. These detectors should operate in a constantly attended area and should be interlocked to shut off the fuel supply.

The compartment ventilation system should be interlocked to shut off in the case of a system discharge. Automatic closing doors or dampers should also be provided for openings not normally closed.

A full discharge test should be conducted to verify that extinguishing concentrations can be maintained for the rundown time of the engine (or 20 minutes minimum). If this test has not been conducted, the system should not be considered reliable.

Gaseous agent fire suppression systems should be designed to have the capacity to supply 2 full discharges in order to avoid having to keep the engine shut down until the gaseous agent reservoir can be replenished, in particular after a minor fire or accidental discharge.



4. TRANSFORMER

Note:

- The following recommendation addresses Polychlorinated Biphenyls (PCB) free oil-filled transformers.
- When PCB-filled transformers exist, it is recommended to replace them with PCB-free transformers. Alternatively, flush and fill the transformers with PCB-free fluid. This should be investigated with the manufacturer.
- An explosion suppression system is not a substitute for the following recommended protection. Moreover, when such systems exist, they should be FM-approved and UL-listed.

Based on NFPA 850 Recommended Practice for Fire Protection for Electric Generating Plants and High Voltage Direct Current Converter Stations:

1) Indoor oil-filled transformer exposing facilities:

In order to prevent an oil-filled transformer from severely exposing facilities inside the site in case of fire or explosion, the following fire protection solutions and their potential alternatives should be considered in detail:

- I) The indoor oil-filled transformers should be replaced with dry-type transformers when possible.

or

- II) The indoor oil-filled transformers should be relocated outside the building in compliance with point 2] or attached to the building in an open cell [point 3] and well segregated from other oil-filled transformers [point 4] below.

or

- III) The following fire separation (i.e. cut-off room) and/or fixed fire protection should be provided:

- a) Oil-insulated transformers of greater than 380 L (100 gallons) oil capacity installed indoors should be separated from adjacent areas by fire barriers with a 3-hour fire-resistance rating. No fixed fire protection is required as per NFPA.
- b) Transformers with a rating greater than 35 kV, insulated with a less flammable liquid or nonflammable fluid and installed indoors should be separated from adjacent areas by fire barriers with a 3-hour fire-resistance rating. No fixed fire protection is required as per NFPA.
- c) When the transformers are protected by an automatic fire suppression system (see point iv below), the fire barrier fire-resistance rating may be reduced to 1 hour.
- d) Combustible (mineral) oil-filled transformers, including the adjacent non-absorbing ground areas, should be protected with an automatic water-based spray system. The minimum density is 10 mm/min (0.25 gpm/sq ft) for the surface area of the transformers and 6 mm/min (0.15 gpm/sq ft) on the non-absorbing ground areas.

If a wet pipe sprinkler system is installed, the protection should be based on a minimum density of 12.2 mm/min (0.30 gpm/ sq ft) over the entire area containing the transformer(s) and extending 6.1 m (20 ft) beyond (or over the entire room housing the transformers, up to 232 m² [2500 sq ft]).

Gas protection systems are not recommended as it is difficult to maintain the design concentration for a sufficient length of time and the fire might start again when the door is opened for final firefighting operations.

Water mist systems are not recommended for reasons of reliability.

Adequate oil containment should be provided as per Section 7.

- e) For transformers with approved less flammable dielectric fluids:



- With approved less flammable transformer fluids, no fire protection is required when the equipment is located inside a one-hour fire-rated room.
- If the transformer is located inside a noncombustible room (but less than one-hour-rated), a sprinkler protection should be provided over the entire room, with a minimum density of 8mm/min (0.20 gpm/sq ft) over the entire area.

2) Oil-filled transformers in open front cells attached to the building:

The fire resistance of the existing walls and roof of the open front cells housing the existing oil-filled transformers should be upgraded when needed, in accordance with the quantity of insulating liquid in the transformer as follows:

- I) For 0.38 cum (100 US gal) or less, one of the following methods should be used:
 - a) Location within a one-hour fire-resistant cell. Moreover, an adequate and approved heat detector should be installed under the roof.
 - b) Location within a less than one-hour fire-resistant cell and provided with an adequate and approved automatic sprinkler protection system (discharge density of 12.2 mm/min [0.30 gpm/ft²] over the area of the cell).
- II) For more than 0.38 cum (100 US gal), one of the following methods should be used:
 - a) Location within a three-hour fire-resistant cell. Moreover, an adequate and approved heat detector should be installed under the roof.
 - b) Location within a one-hour fire-resistant cell and provided with an adequate and approved automatic sprinkler protection system (discharge density of 12.2 mm/min [0.30 gpm/ sq ft], over the protected area or over the area of the cell).
- III) Adequate oil containment should be provided, as per Section 7.
- IV) The project should be reviewed by a qualified Fire Protection Engineer familiar with NFPA standards.

3) Outdoor oil-filled transformer exposing facilities:

In order to prevent an oil-filled transformer from severely exposing facilities inside the site in case of fire or explosion, the following fire protection solutions and their potential alternatives should be considered in detail:

- I) The oil-filled transformers should be replaced with dry-type transformers when possible.
- or
- II) Consider any one of the following alternatives to protect the exterior walls of main buildings against exposure to outdoor transformer fires:
 - a) Provide spatial separation as indicated below (source NFPA850 Table 6.1.4.3):

Transformer Oil Capacity		Minimum (Line-of-Sight) Separation Without Firewall - X	
Cum	gal	m	Ft
1.9	500	1.5	5
1.9-19	500-5,000	7.6	25
>19	>5,000	15	50

Note: The above spatial separating distances are measured from the edge of the postulated oil spill (i.e. containment basin, if provided).



- b) Provide a 2-hour-rated fire barrier (i.e. a concrete block or reinforced concrete) with the same horizontal and vertical measurements as in the table above.

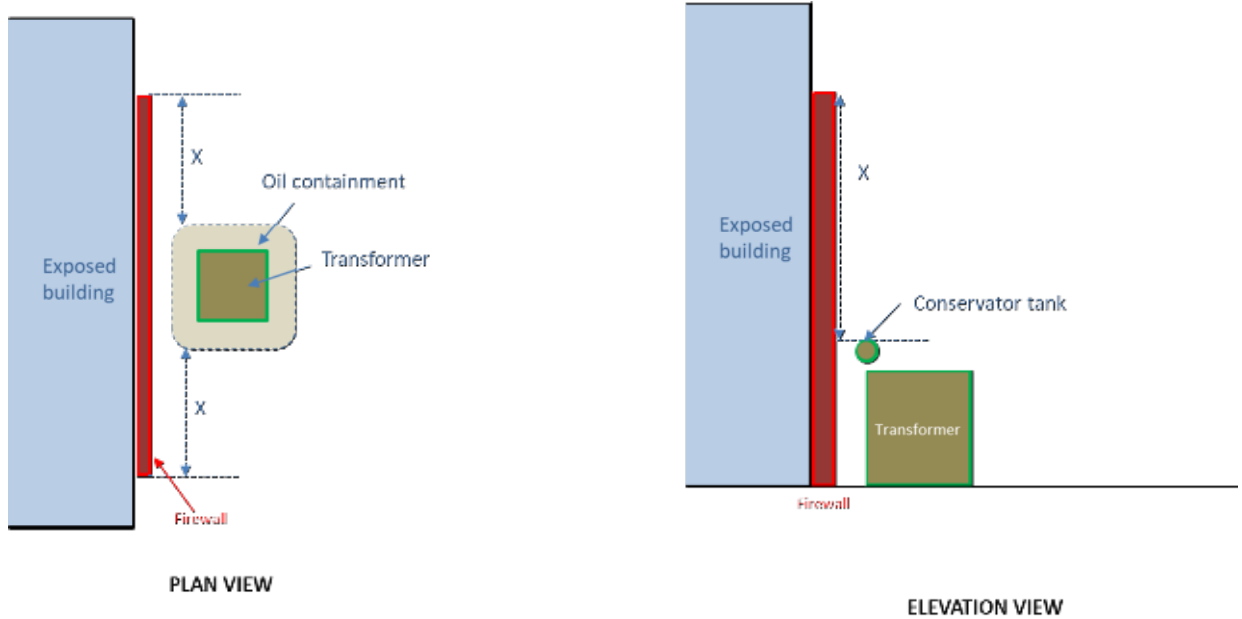

Courtesy of FPO. (from NFPA 804 & 850 standards)

- c) When a firewall is provided between the structures and a transformer, it should extend vertically and horizontally in accordance with the table above, as follows:

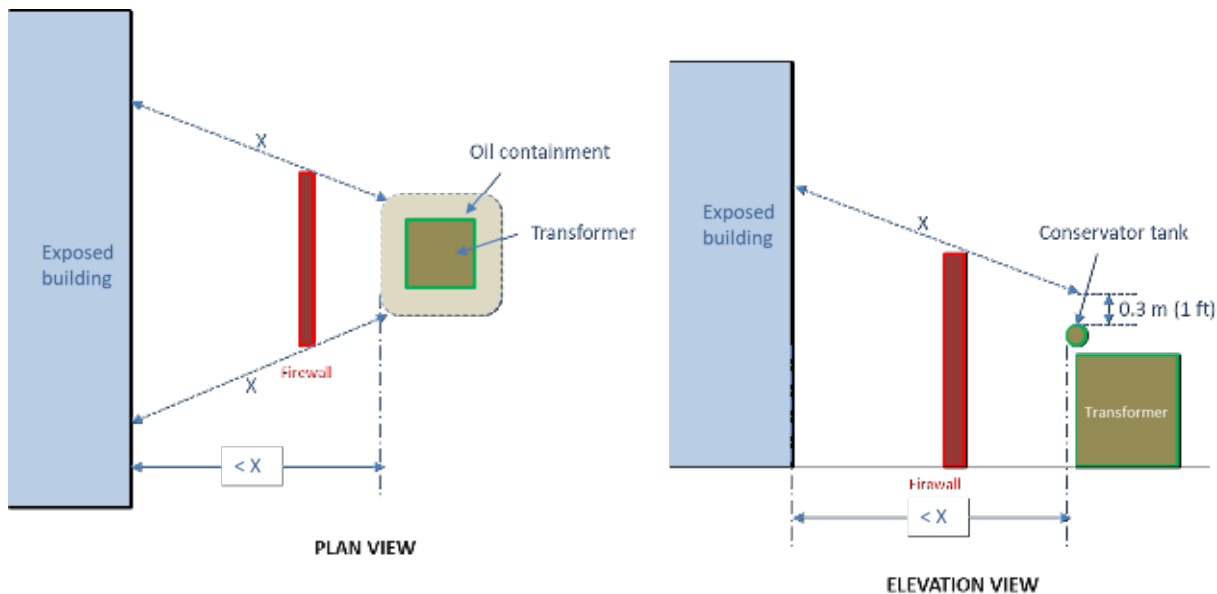

Courtesy of FPO. (from NFPA 804 & 850 standards)

Notes:

- As a minimum, the firewall should extend at least 0.3m (1ft) above the top of the transformer casing and oil conservator tank, and at least 0.6m (2 ft) beyond the width of the transformer and cooling radiators.
- The wall should extend up to the limit of the oil containment if its width extends beyond the 0.6m (6 ft) indicated above.
- If columns supporting the turbine building roof (if any) at the exterior wall have a 2-hour fire-resistive rating above the operating floor, the firewall need not be higher than required to obtain line-of-sight protection up to the height of the operating floor.
- Adequate oil containment should be provided as per Section 7.



- d) Oil-filled (combustible – mineral oil) mains, service stations and start-up transformers, not meeting the separation or fire barrier recommendations in Table 2] b. i. above, should be protected with automatic water spray systems with water additives or foam-water spray systems (source NFPA850 9.7.9).

Moreover, exposed facilities (i.e. windows or similar openings, walls not fire-rated or less than 2-hour fire-rated) should be provided with automatic fixed fire protection.

See Section 6. “Automatic Fire protection for outdoor oil-filled transformers and exposed facilities”.

Adequate oil containment should be provided as per Section 7.

- e) For Transformers with approved less flammable dielectric fluids:

Courtesy of Franck Orset (FPO).

With approved less flammable transformer fluids, water spray protection and barriers are not needed if the spacing is equal to or greater than that required in the following tables.

Separation from adjacent structures:

Fluid capacity in litres	Horizontal distance (m)			Vertical distance (m)
	2-h fire resistant construction	Non combustible construction	Combustible construction	
< 37 850	1.5	1.5	7.5	7.5
> 37 850	4.5	4.5	15	15

Table 1 – Separation Distances in m between Outdoor Less Flammable Liquid Insulated Transformers and Buildings
(from FM Global Data Sheets 5-4)

Fluid capacity in gallons	Horizontal distance (ft)			Vertical distance (ft)
	2-h fire resistant construction	Non combustible construction	Combustible construction	
< 10 000	5	5	25	25
> 10 000	15	15	50	50

Table 1 – Separation Distances in ft between Outdoor Less Flammable Liquid Insulated Transformers and Buildings
(from FM Global Data Sheets 5-4)

This means that if the above-mentioned minimal separation is maintained, neither fire suppression nor barrier walls are required.

When the above-mentioned distances are not met, a 2-hour firewall should be provided between structures and a transformer. It should extend vertically and horizontally using the distance given in Table 1, as indicated in the Section iii. Diagram above.



4) Outdoor oil-filled transformers mutual exposure:

In addition to the passive fire protection for surrounding facilities recommended in points 1) and 2) above, oil-filled transformers - when not in individual cells - should be separated from the other transformers by:

- I) a minimum separating distance as given in Table 3) II. a. above
- or
- II) a 2-hour-rated fire barrier extending at least 0.3m (1ft) above the top of the transformer casing and oil conservator tank and at least 0.6m (2ft) beyond the width of the transformer and cooling radiators as shown below:

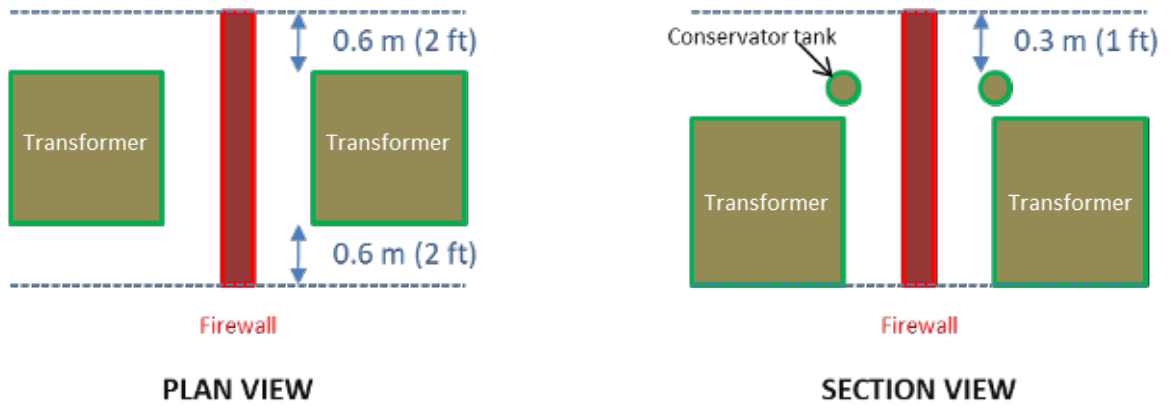

Courtesy of FPO. (from NFPA 804 & 850 standards)

Note:

- Where a firewall is provided, it should be designed to withstand the effects of projectiles from exploding transformer bushings or lightning arresters.
- A higher noncombustible shield may be provided to protect against the effects of an exploding transformer bushing.
- The wall should extend up to the limit of the oil containment if its width extends beyond the 0.6 m (2ft) indicated above.

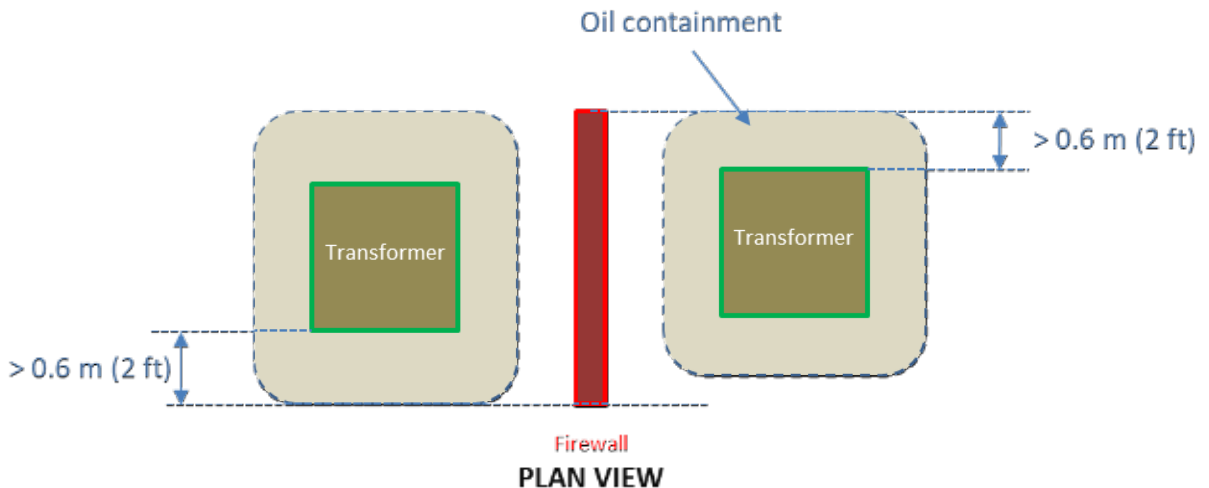

Courtesy of FPO. (from NFPA 804 & 850 standards)

- If columns supporting the turbine building roof (if any) at the exterior wall have a 2-hour fire-resistive rating above the operating floor, the firewall need not be higher than required to obtain a line-of-sight protection up to the height of the operating floor.
- Fixed fire protection should be considered for oil-filled transformers. (See Section 6).



- Adequate oil containment should be provided. (See Section 7).

III) For transformers with approved less flammable dielectric fluids:
Courtesy of Franck Orset (FPO).

Separation from adjacent transformers is given in Table 2:

Fluid capacity in litres	Min. separation in metres
< 37 850	1.5 m
> 37 850	7.5 m

Table 2 – Outdoor Less Flammable Fluid Insulated Transformers Equipment Separation Distances in m between adjacent transformers
(from FM Global Data Sheets 5-4)

Fluid capacity in gallons	Min. separation in ft
< 10 000	5 ft
> 10 000	25 ft

Table 2 – Outdoor Less Flammable Fluid Insulated Transformers Equipment Separation Distances in ft between adjacent transformers
(from FM Global Data Sheets 5-4)

This means that if the above-mentioned minimal separation is maintained, neither fire suppression nor barrier walls are required.

When the above-mentioned distances are not met, a 2-hour firewall should be provided between transformers. It should extend vertically and horizontally as indicated in the Section ii. Diagram above.

Fixed fire protection should be considered for oil-filled transformers. (See Section 6).

Adequate oil containment should be provided. (See Section 7).

5) Illustration of outdoor oil-insulated transformer exposing facilities and mutual exposure spacing (points 3 and 4 above):

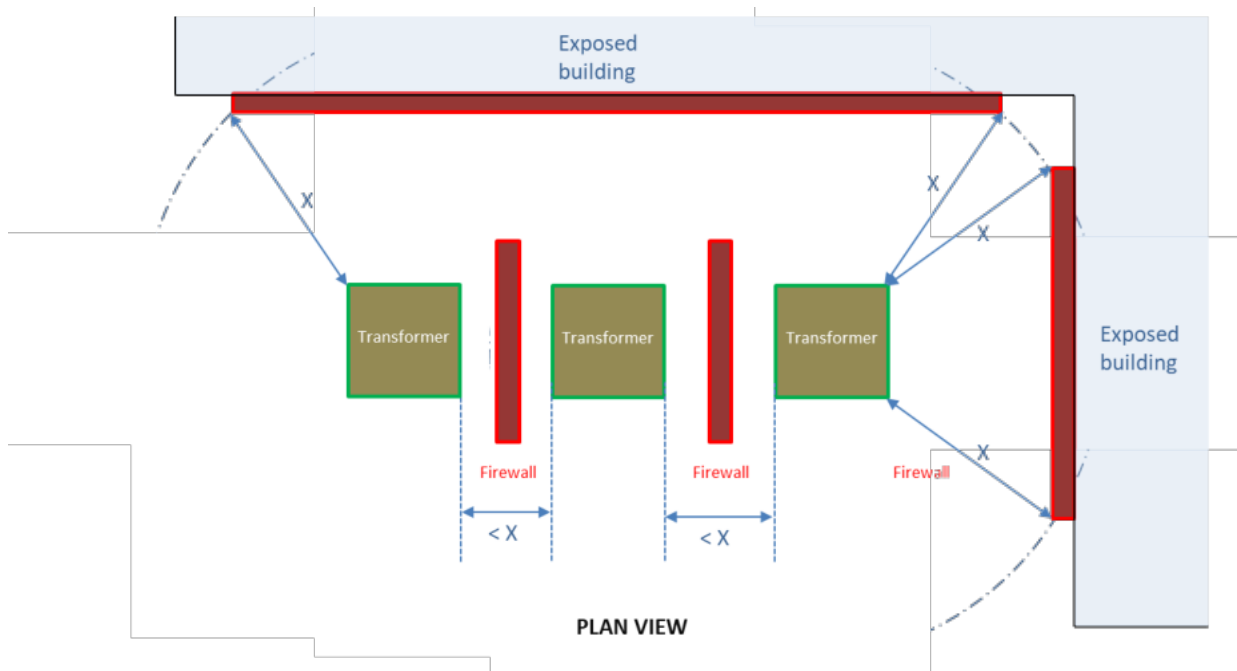

Courtesy of FPO



- Fixed fire protection should be considered for oil-filled transformers and exposed facilities. (See Section 6).
- Adequate oil containment for oil filled transformers should be provided. (See Section 7).

6) Automatic Fire Protection for outdoor oil-filled transformers and exposed facilities:

I) Fixed fire protection of outdoor oil-filled transformers:

a) The following fixed fire protection is suitable for:

- Oil-filled (combustible – mineral oil) mains, service stations and start-up transformers not meeting the separation or fire barrier recommendations in Table 2] b. i. above.
- Reducing the lead time required for the manufacturing and shipping of a new transformer by allowing repairs, when possible, considering that the fire would be controlled in its early stages of development.

Design density:

- Not less than 10.2 L/min/m² (0.25 gpm/ft²) of the projected area of the rectangular prism envelope for the transformer and its appurtenances, and not less than 6.1 L/min/m² (0.1 gpm/ft²) on the expected non-absorbing ground surface area of exposure.
- The spray system should be activated on a pilot line or by an FM-approved fire detection system. Note that in recent years some transformers have been designed with relatively high design temperatures. Operating cooling fans can release large amounts of heat that can inadvertently trip deluge systems using rate-of-rise or rate-compensated heat detection equipment. To avoid these inadvertent trips, fixed temperature heat detection systems should be used to activate transformer deluge water spray systems.
- Adequate oil containment should be provided. (See Section 7).
- Nozzles should be positioned so that the water spray does not envelop energized bushings or lightning arresters by direct impingement (unless authorized by the manufacturer).
- Detection of a fire should preferably be undertaken by the use of sprinkler heads, set into a separate air-pressurized line (pilot line).

b) For Transformers with approved less flammable dielectric fluids:

- When the minimum required distances are not met and/or when the transformers could expose adjacent structures, buildings or major equipment, there should be an automatic water spray system installed.
- These transformers should be installed inside concrete shields protecting buildings and other transformers from heat and smoke.
- Transformers, including the adjacent non-absorbing ground areas should be protected with an automatic water-based spray system.
- The minimum density is 10 mm/min (0.25 gpm/sq ft) for the surface area of the transformers and 6 mm/min (0.15 gpm/sq ft) on the non-absorbing ground areas.
- Nozzles should be positioned so that the water spray does not envelop energized bushings or lightning arresters by direct impingement (unless authorized by the manufacturer).
- Detection of a fire should preferably be undertaken by the use of sprinkler heads, set into a separate air-pressurized line (pilot line).

II) Fixed fire protection for exposed facilities:

a) For protection of windows or similar openings, the following design criteria should be considered:

- Sprinkler heads should be positioned within 5 cm (2") of the top of the window and 30 cm (12") from the window surface. For windows up to 1.5 m (5 ft) wide, only one sprinkler



head is required to protect the openings. For windows from 1.5 (5 ft) to 3.7 m (12 ft) wide, 2 sprinkler heads are required.

- Sprinkler heads should be positioned so that a certain amount of water discharge could run down the side of the building and cool the exposed surface. Provisions should be made so that the water remains in contact with the wall and/or window surface while running down. Special consideration should be given to potential wind effects, so that the surface can be properly wetted.
- b) For the protection of openings in a fire separation wall, the following design criteria should be considered:
- Water curtain: sprinklers in a water curtain should be hydraulically designed to provide a minimum discharge of 37 L/min (10 gallons/min) per lineal meter of water curtain, with no sprinkler head discharging less than 57 L/min (15 gallons/min) (minimum operating pressure of 0.5 bar (7 psi) for K80 (K5.6) sprinkler heads).
 - Sprinkler exposure protection (automatic sprinkler or deluge systems)
 - Protection should be hydraulically designed to provide a minimum operating pressure of 0.5 bar (7 psi) with all sprinklers facing the exposure operating (or the entire deluge heads for a deluge system).
- c) For the protection of an exposed wall (not fire-rated or less than 2-h fire-rated), the following design criteria should be considered:
- The protection should be provided to cover the entire surface represented by the minimum distance indicated below:

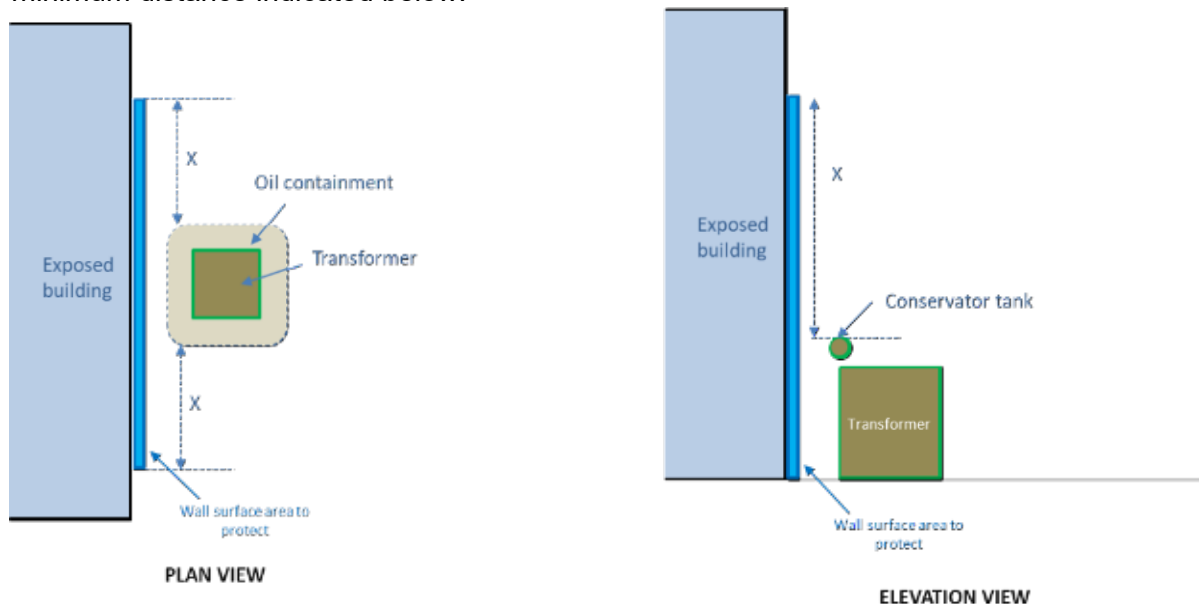

With:

$x = 7.5 \text{ m (15 ft)}$ if the transformer's oil capacity is $< 18\,900 \text{ l (5000 gallons)}$
and 15 m (50 ft) if the transformer's oil capacity is $> 18\,900 \text{ l (5000 gallons)}$.

- The transformer should be located at least 1.5 m (5 ft) from the wall.
- The sprinkler protection should be designed to deliver a minimum density of 8 mm/min (0.20 gpm/sq ft) over the entire surface, with a design for direct impingement application, or to provide a rundown application with a maximum distance between levels of 3 m (10 ft).
- Sprinkler heads' location: for wall protection systems, sprinkler heads should be located 15 cm (6") to 30 cm (12") from the wall surface and within 15 cm (6") from the top of the wall, with a maximum spacing of 2.4 m (8 ft) between sprinkler heads.



When water curtain protection is provided against a wall (protection against external exposure) because of the presence of openings (windows, louvers, walls with combustible insulation...), the sectional valve for the supply of the water curtain should be from a supply that is independent from that of the protection for the transformer.

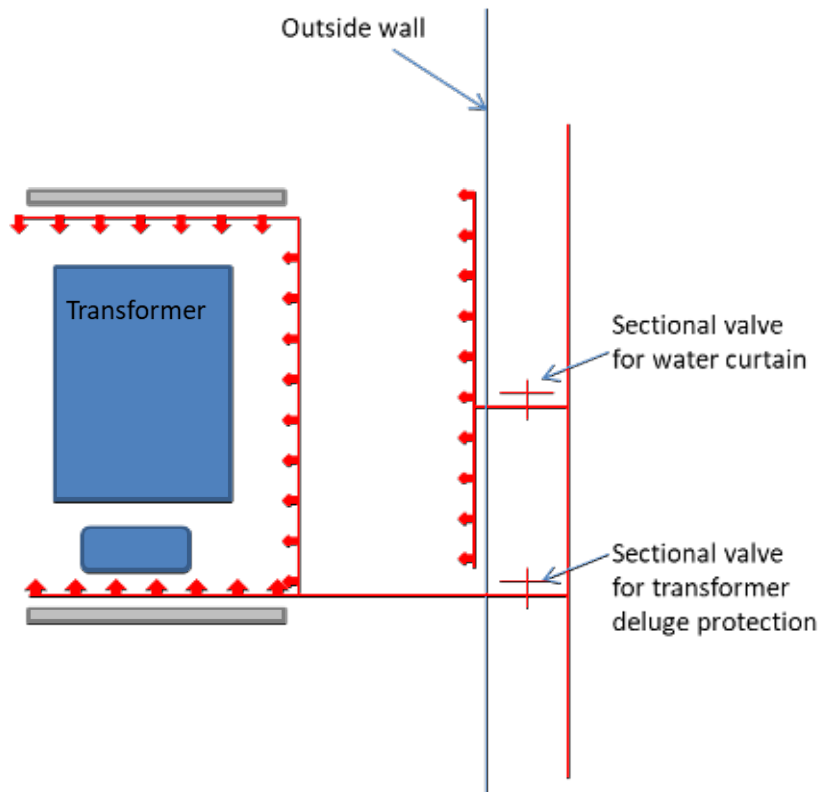

Courtesy of Franck Orset (FPO)

This is to be sure that in case of failure of the deluge protection on the main transformer, it is still possible to isolate the sectional valve controlling the transformer without affecting the water flow on the water curtain.

7) Oil containment:

- Outdoor liquid-filled transformers should be provided with spill containment if the accidental release of the transformer fluid could expose a main building, adjacent equipment or storage to fire damage.
- A catch basin should be provided beneath each transformer with sufficient capacity to hold 120% of the oil contents of the transformer, or retention with a drain, leading to an underground tank.
- The area of the bund should be sufficient to capture all oil ejected from pressure relief devices, ruptured bushing turrets, main tanks, oil coolers and the conservator.
- The provision of crushed stones is a good practice to prevent large fires at the transformer location.
- In the event of a transformer failure, the spilling oil will effectively be cooled down by the yard stones to below the combustion temperature. The stones will effectively prevent the oil from burning uncontrolled throughout the containment area.
- Only the area that was exposed to the oil spill will have surface oil that will burn until dry. This will minimize the actual time and severity of the fire due to the limited amount of surface oil and the reduction in oil temperature.
- In passive systems with crushed stone, no less than 300 mm (12 in.) of stone should be provided to extinguish the oil, if on fire. Smaller stone is more effective and 20 mm to 40 mm (¾ in. to 1½ in.) is recommended. While larger stone permits quicker penetration by the oil, its size makes it less effective as a quenching stone.



- The volume of the bunding and the rock ballast must be sufficient to hold the total volume of oil from the transformer at 100 mm (4 in.) below the surface of the rocks to ensure that a pool fire is not sustained.
- Note that rock ballast tends to collect dust and other wind-borne debris over time and may silt up and require cleaning at infrequent intervals.
- A system for removal of rainwater from the containment area should be provided.

5. ELECTRO-STATIC PRECIPITATOR (ESP)

The following points should be considered in detail:

I) All oil-filled transformer supports located at the top of ESPs should be provided with adequate stoppers in order to prevent any horizontal and vertical movement in case of earthquake tremors (in regions with EQ exposure).

II) In order to prevent oil-filled transformers from severely exposing the Electro Static Precipitator in the case of fire or explosion, the following fire protection solutions and their potential alternatives should be considered in detail:

- a) The oil-filled transformers should be replaced with dry-type transformers when possible.
- or
- b) The oil-filled transformers installed above the ESP should be adequately protected as per NFPA850 as follows:
 - Adequate automatic spray (deluge) systems should be installed above the transformers in accordance with NFPA standards. All material and equipment should be FM-approved and/or UL-listed. All alarms should be relayed to a constantly attended location. This protection should be fed by an adequate and reliable Fire Water supply.
 - A catch basin should be provided beneath each transformer with sufficient capacity to hold 120% (oil and fire water) of the oil contents of the transformer, or a retention with a drain leading to an underground tank.
 - The project should be reviewed by a qualified Fire Protection Engineer familiar with NFPA standards.

Comments:

Oil-filled transformers constitute a severe exposure threat to ESPs as they are usually located at elevated levels on top of the ESP. Technically speaking, thermal power generating units, boilers and kilns could operate without an ESP. However, sometimes local environmental regulations stipulate that an ESP is mandatory.

I) In the case of an EQ tremor (EQ exposed areas), these transformers may fall out of the rails and be damaged so that the combustible insulating oil is released and may be ignited by a hot surface or by friction resulting in fire and loss.

II) In the case of an explosion and/or a fire involving an oil-filled transformer, oil would spread over the ESP, resulting in severe property damage and potential shutdown. Safe and efficient manual firefighting at such heights would be virtually impossible.



6. SUBSTATION / MCC ROOM / SERVER ROOM / ELECTRIC ROOMS

All Substations / MCC Rooms / Server Rooms / Electric Rooms that have no physical well segregated backup (located in a different fire / flood / other perils area than the main unit) and that may lead to production disruption in the case of a total loss should be identified. These facilities are deemed as critical.

The following solutions a), b) and c) and their alternatives should be considered in detail for these critical utilities:

- a) **Duplication:** a full backup should be provided for these rooms. This can consist of duplicating these rooms (so that in the case of a loss on a hot site, the standby room could immediately take over, or on a cold site there would be a limited switch time for limiting interruption). The main room and the back-up room(s) should be located in different well separated fire areas consisting of a minimum separating distance (25 m for noncombustible construction and 40 m for combustible construction) or a physical barrier (at least a 2-hr fire partition without any opening such as a door or even a fire door which risks being left open), false floors / ceiling penetrations or windows. An adequate NFPA and FM-approved automatic fire detection system should be installed in both the main room and the back-up room.

and/or

- b) **Protection:** if a backup or any other redundancies are not available or cannot be fully completed, as detailed in point a) above, the following fire protection alternatives should be considered:
 - Rooms housing electric equipment such as cable vaults, breakers, drivers, PLC cabinets, GIS bay cabinets, etc.:

For standard size airtight rooms: Approved and adequate automatic gaseous extinguishing total-flooding inside the rooms and inside the cable trench / false floor / false ceiling should be considered. For reliability, these gaseous extinguishing systems could be of the double-shot type and and/or an automatic wet pipe sprinkler protection system under the ceiling could provide an adequate backup in the case of single / double-shot gaseous extinguishing systems. Wet pipe sprinklers for trenches / false floors at least 80 cm deep can be also considered.

or:

For large size non-airtight rooms: Approved and adequate automatic wet pipe sprinklers under the ceiling and inside the cable trenches / false floors / false ceilings of at least 80 cm deep should be considered. Should the site have concerns about electrical shocks and/or accidental water discharge, a pre-action system could be considered for the cabinet rooms. (A wet pipe sprinkler and pre-action - minimum design density should be 6 mm/min (0.15 gpm/sq ft) over 186 m² (2000 sq ft) with K80 (K 5.6) standard spray sprinklers rated at 68°C (165°F) - are suitable for large size rooms and when it is difficult to make the room airtight for a gaseous extinguishing system).

or:

For control panels in large size rooms - high ceilings, relatively low combustible load (i.e. GIS / control bay panels in process areas): Approved and adequate automatic gaseous extinguishing systems locally discharging inside the cabinets and inside the cable trenches / false floors / false ceilings should be considered. For reliability purposes, these gaseous extinguishing systems could be of the double-shot type and/or an automatic wet pipe sprinkler protection system under the ceiling could provide an adequate backup in the case of single / double-shot gaseous extinguishing systems. Wet pipe sprinklers for false floors of at least 80 cm deep can also be considered.



and:

- Cable vaults / tunnels:

Cable vaults and tunnels should be protected with an approved and adequate automatic wet pipe sprinkler protection system. Moreover, cables in open-side cable vaults exposed to wind should also be coated with adequate and FM-approved intumescent material.

and:

c) **Contingency Plan:**

A Contingency Plan should be developed in the case of a loss of a Substation / Electric Room identifying by-pass possibilities, vendors and/or manufacturers or locations where spare cabinets are available. The lead time and installation time should be investigated by specialists. The Contingency Plan should be formalized, regularly reviewed and updated. Ownership and leadership should be clearly defined.

d) **Important Note:**

The following points regarding the above fire protection solutions and their potential alternatives should be considered:

- **Gaseous extinguishing agent:** carbon dioxide (CO₂) is very dangerous for humans (lethal). As a result, for any normally occupied or occasionally occupied areas, we strongly recommend an automatic system using safe gaseous extinguishing agents for personnel, such as "Inergen" or "Argonite" or approved clean agents such as FE227 and FM200, in accordance with NFPA 2001. The recommended extinguishing agent density should be such that the oxygen concentration in the room does not drop below the safety limit. If a carbon dioxide system is selected for a raised floor, a special low-velocity discharge system should be used so that the carbon dioxide does not rise above knee height in the room. Under-floor halocarbon agent systems (e.g. FE227 and FM200) are not permitted when the space above the raised floor is not equipped with a halocarbon agent system. A fire in the space above the raised floor could draw the discharged halocarbon agent upwards, causing it to decompose and become very toxic. Only equipment tested and approved by a recognized laboratory should be accepted.
- **Ventilation Interlock:** the ventilation system should be interlocked to the fire detection / protection system in order to shut down automatically upon fire detection. Ventilation interlocks should permit ventilation to stop when fire is detected in a room. This is in order to avoid the supply of oxygen to a fire and the escape of gaseous extinguishing agents, when provided.
- **Ventilation Duct Segregation:** fire dampers should be installed in each ventilation system which is common to different rooms. These dampers should be interlocked to their respective fire detection system, to close automatically in case of fire detected in one of these rooms. Some ventilation ducts may be common to at least 2 utility rooms. Without fire dampers closing when fire is detected in a room, smoke may spread to the adjacent rooms and gaseous extinguishing agents may also escape from the room where it has been discharged, through the ventilation duct.
- **Water-Based Fire Protection & Electric Shocks:** regarding sprinkler protection, should the plant have concerns about electric shocks, the mains switch may be interlocked to the sprinkler system in order to de-energize the area in case of sprinkler water discharge.
- **Fire Water Supply:** the above recommended sprinkler protection should be fed by an adequate and reliable fire water supply in accordance with the latest version of NFPA, as recommended.
- **Alarms and signals:** all fire alarms, supervisory signals and trouble signals should be relayed to a constantly attended location.



- **Materials and equipment:** all fire detection / protection material and equipment should be UL-listed or FM-approved and should be installed by a qualified contractor familiar with NFPA/FM standards.
- **Plan Review:** the project should be reviewed by a qualified Fire Protection Engineer familiar with NFPA standards.

Comments:

Solution a) consisting of adequately segregated redundancies is the most reliable but also the most expensive.

Solution b) is the most efficient when a) is not possible. Automatic Sprinkler wet pipe or pre-action systems are suitable for large size rooms and when it is difficult to make the room airtight for a gaseous extinguishing system.

Automatic fire protection systems can fail (i.e. faulty design, lack of maintenance, impairment). Back-up systems (sprinkler and pre-action) for gaseous extinguishing systems are therefore recommended.

Cable coating (2-hour fire-rated maximum) in cable vaults is an acceptable solution for areas handling material that could react with water (i.e. hot molten metal). This should however not be a systematic substitute for an automatic sprinkler in other areas. For open-side cable vaults exposed to wind that could divert water discharge, both automatic sprinklers and coatings providing mutual backup are recommended.

Solution c) – the Contingency Plan- is not a substitute for either duplication (point a. above) or automatic fire protection (point b. above). The main purpose of a Contingency Plan is to limit Business Interruption in case of the loss of a protected room (protection could be impaired) with or without redundancies provided, as per point A. In such cases the CP aims at ensuring the availability / reliability of the redundancy(ies) (if any).

The ultimate goal of this recommendation is to mitigate the impact of Business Interruption. The decision should be based on ‘what-ifs’ and risk / benefit analysis.

7. CABLE OPENINGS / CABLE TRAYS & RUN / CABLE VAULTS / CABLE TUNNELS

The following points should be considered in detail:

A) All Cable Openings to substations, electrical rooms, MCC rooms, electric cabinets, control rooms, rack rooms, server rooms and processing areas, should be sealed with an FM-approved fire sealant. If these openings are only temporary, then approved provisional sealing materials should be used. Cable openings could be filled with noncombustible insulation material (glass wool) and sealed with noncombustible gypsum material as an acceptable alternative to an approved fire sealant.

B) All horizontal Cable Trays running in processing areas should be provided with large fire breaks, 2 m in size, made from FM-approved noncombustible intumescent paint, applied on cables every 30 m. As an acceptable alternative to approved intumescent material, noncombustible gypsum material could be applied to cable trays.

C) In vertical Cable Runs, the trays should have a fire barrier installed every 10 m. The cable openings between the floors of buildings should be sealed with FM-approved fire-resistant material.

Comments:

A) Some polyurethane foams contain a fire retardant. The retardant allows the flammability of the PU foam to be temporarily reduced by reducing ignition potential and flame spread. However, when exposed to a sustainable fire, the combustible PU foam will burn. Furthermore, the property of the fire retardant may change depending on time and ambient conditions. In



order to be approved, fire-retardant materials need to be tested by NFPA 255, *Standard Method of Test of Surface Burning Characteristics of Building Materials*. As a result, we strongly recommend the use of approved sealant noncombustible intumescent material.

B), C) Long unprotected cable trays usually run along the inside of processing areas. A potential fire could spread along the entire length of the cables, from one area to another.

8. BATTERY ROOM (ESS)

Courtesy of Franck Orset (FPO) Loss Prevention Engineer:

Based on NFPA855 ed 2020 “Installation of Stationary Energy Storage Systems” and FM Global Data Sheets 5-33 “Electrical Energy Storage System”

Standard:

- Closed hydrogen systems are preferred for Energy Storage Systems (ESS).

Location:

- Batteries should be installed in a separate 1-h fire compartment.
- Energy Storage Systems (ESS) should be arranged in groups with a maximum energy capacity of 250 kWh each.
- Each group should be spaced at least 90 cm (3 ft) away from other groups and from walls in the storage room or area.

The maximum rated energy should be 600 kWh.

Storage:

- No combustible storage, unrelated to the battery room, should be allowed inside the room.
- Combustible material related to the battery room should be stored at a minimum distance of 90 cm (3 ft) from the equipment.

Electrical equipment:

- All electrical equipment installed or used in battery rooms should be explosion-proof.

Direct current switchgear and inverters should not be located in the battery rooms.

Ventilation:

1. Battery rooms (flooded lead-acid, flooded Ni-Cd and VRLA batteries) should be provided with natural ventilation to limit the concentration of hydrogen to 1% by volume (25% of the LEL – Lower Explosive Limit) and equipped with a hydrogen detection system. The hydrogen concentrations should be monitored.

or:

2. Mechanical exhaust ventilation should be provided at a rate of not less than 1 cubic foot per minute per square foot (1 ft³/min/ft²) [0.0051 m³/s / m²] of the floor area of the room and should be activated by a hydrogen detection system set to operate the ventilation at 25% of the LEL (1% of H₂ inside the room).

The hydrogen concentrations should be monitored.

The mechanical ventilation should remain on until the flammable gas detected is less than 25% of the LEL.

or:

3. Continuous ventilation should be provided at a rate of not less than 1 cubic foot per minute per square foot (1 ft³/min/ft²) [0.0051 m³/s / m²] of the floor area of the room.



Excessive concentrations (>1 % vol.) and/or loss of ventilation and/or failure of the gas detection system should sound an alarm signal at a constantly attended location (Main Control Room).

The exhaust ventilation lines should be located at the highest level of the fire compartment.

Exception: Lithium-ion and lithium metal polymer batteries should not require additional ventilation beyond that which would normally be required for human occupancy of the space.

Detection:

- Fire detection should be provided inside the room.

Room protection:

- Battery rooms should preferably be protected by automatic sprinklers designed to deliver a minimum density of 12.2 mm/min (0.3 gpm/sq ft) over the entire area of the room or 232 m² (2500 sq ft) - whichever is smaller.
- Thermal runaway events create a large amount of heat. The heat, coupled with plastic construction components, can lead to a very large fire. Although sprinkler protection may not be practical in exterior installations, it is the best method for cooling a fire involving an ESS.
- Total flooding gas protection systems could be provided and should be designed to maintain the design concentration within the enclosure for a time sufficient to ensure that the fire is extinguished and that ESS temperatures have cooled to below the autoignition temperature of the combustible material present and the temperature that could cause thermal runaway (with a minimum of 10 minutes).
- The design of the system should be based on:
 - The agent concentrations required for the specific combustible materials involved
 - The specific configuration of the equipment and enclosure

Protections by water mist or dry chemical systems are not advised/recommended.

9. RUBBER BELT CONVEYOR

The following points should be considered in detail:

A) **Identification:** All critical rubber belt conveyors should be identified.

B) **Contingency Plan:** a Contingency Plan should be developed in case of loss of a critical rubber belt conveyor including the belt and its structural support, identifying vendors and/or manufacturers or locations where spare conveyors are available.

or:

C) **Protection:** in case the replacement time is not acceptable from a Business Interruption standpoint, an automatic sprinkler protection system, complying with International Standards (NFPA / FM Global Data Sheets 7-11 Conveyor Belts) should be installed for all critical rubber belt conveyors.

- The belt drivers should be interlocked to the sprinkler system to enable them to stop automatically in the case of water discharge.
- All fire alarms, perturbations and supervisory signals should be relayed to a constantly attended location.
- All material and equipment should be approved and/or UL-listed.
- A project plan review of the fire protection systems should be conducted by qualified, recognized fire protection engineers familiar with NFPA / FM standards prior to installation, and a visit on site should be conducted during and after installation for final approval.
- The protection system should be installed by qualified contractors.



Comment:

Although the conveyed product and the structure may be noncombustible, loss history demonstrates that the belt itself presents a sufficient combustible loading to spread the fire without any other fuel contribution.

The fire velocity itself would be so great that it would not only result in the major loss of a conveyor belt, but also of structural members, such as gantries and legs supporting the overhead conveyor.

Moreover, in certain situations, such as a covered and/or elevated position, rubber belt conveyors should be considered inaccessible for manual firefighting. In case of inclined rubber belt conveyors, the slope (more than 10%) allows for a faster-spreading flame front. Underground conveyors are extremely difficult to access.

The conveyors may represent a long downtime in the case of a fire event. The use of a fire-resistant belt may lower the hazard risk, but it will still burn, and a protection system is, therefore, still required.

Because conveyor belts have relatively slow burning characteristics, sprinklers are very effective in gaining early control.

Courtesy of Franck Orset (FPO) Loss Prevention Engineer:

For closed sprinkler head protection systems, sprinkler heads should preferably be rated at 74°C (165°F) and have a K115 (8.0) orifice size.

If the ambient temperature in the area is above 45°C (113°F), then intermediate or high temperature sprinkler heads can be used - 93°C (100°F) or 141°C (286°F). A minimum of 30°C (86°F) should be maintained between the highest ambient temperature expected and the temperature rating of the sprinklers.

In areas subjected to freezing conditions, dry or pre-action systems are preferable options.

The fire protection should be designed in accordance with the following table:

Belt orientation	Sprinkler system type	Sprinkler spacing	Sprinkler demand	
			Number of operating sprinklers	Flow per sprinkler
<10°	Wet, dry or pre-action	3.7 m (12 ft)	10	95 lpm (25 gpm)
10-30°	Wet, dry or pre-action		15	95 lpm (25 gpm)
>30°	Deluge		All sprinklers on a single system	12 mm/min (0.3 gpm/sq ft) over the entire area

Note that NFPA 850 only recommends a design density of 10 mm/min (0.25 gpm/sq ft) over 186 m² (2000 sq ft) of the enclosed area or the most remote linear 30 m (100 ft) of the conveyor structure up to 186 m² (2000 sq ft). This protection is not associated to the belt orientation and is considered insufficient for an orientation above 30°.

Linear heat detection systems should be provided to activate the pre-action or deluge systems. The maximum water delivery time should not exceed 60 seconds for dry or pre-action systems.

There should be a 60-min water duration for the system.

For conveyors more than 3 m (10 ft) wide, the maximum sprinkler coverage area should be 100 sq ft (with a maximum spacing of 3.7 m (12 ft) between sprinklers).



The location of sprinklers over conveyors should comply with the following rules:

For indoor conveyors:

Pendent sprinklers should be provided along the centerline of the belt.

If sidewall sprinklers are provided, there are 2 possibilities, depending on the belt width:

Belt width < 1.8 m (6 ft): position sidewall sprinklers along one side of the belt

Belt width > 1.8 m (6 ft): position sidewall sprinklers staggered along both sides of the belt (i.e. the sprinkler heads on one side of the belt are spaced 7.4 m (24 ft) maximum apart).

For outdoor conveyors:

The sprinklers should be located in accordance with the following diagrams for outdoor conveyors (the occupancy is assumed to be noncombustible, apart from the conveyor or conveyed products).

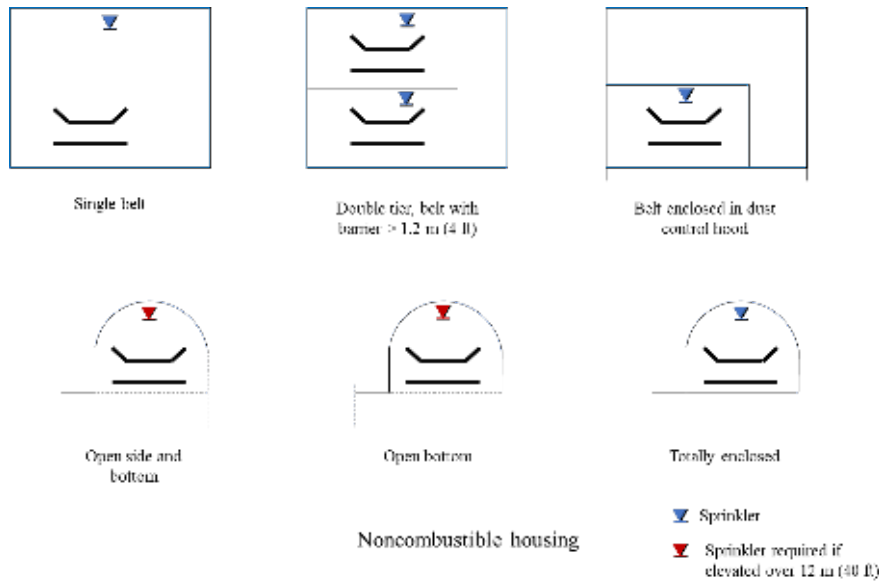

Posted and reprinted with permission of FM Global. ©2015-2019 Factory Mutual Insurance Company. All rights reserved.

Note that there is a difference between combustible and noncombustible housing. Additional sprinkler heads might be required for the protection of the combustible housing, when provided.

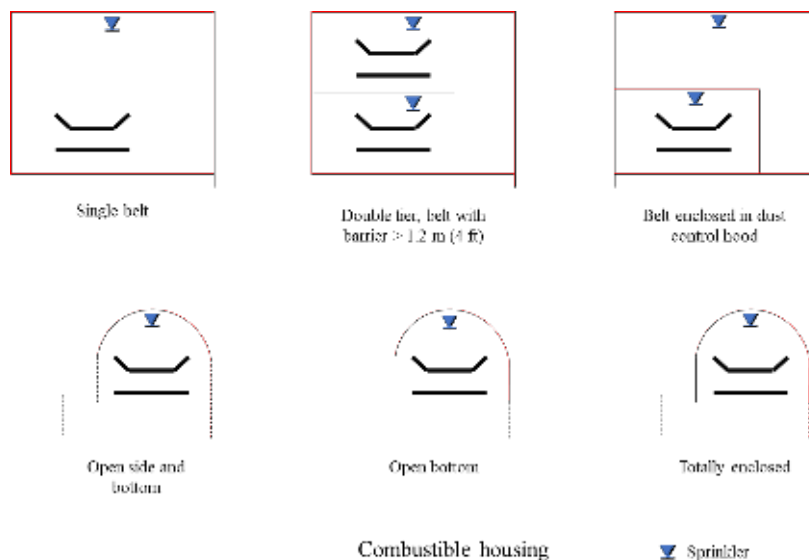

Posted and reprinted with permission of FM Global. ©2015-2019 Factory Mutual Insurance Company. All rights reserved.



For deluge protection, the discharge pattern of the deluge nozzles should envelop the top and bottom belt surface area, conveyor surfaces where combustible materials are likely to accumulate, structural parts, and the idler rolls supporting the belt.

Courtesy of Franck Orset (FPO) Loss Prevention Engineer. (Source NFPA15):

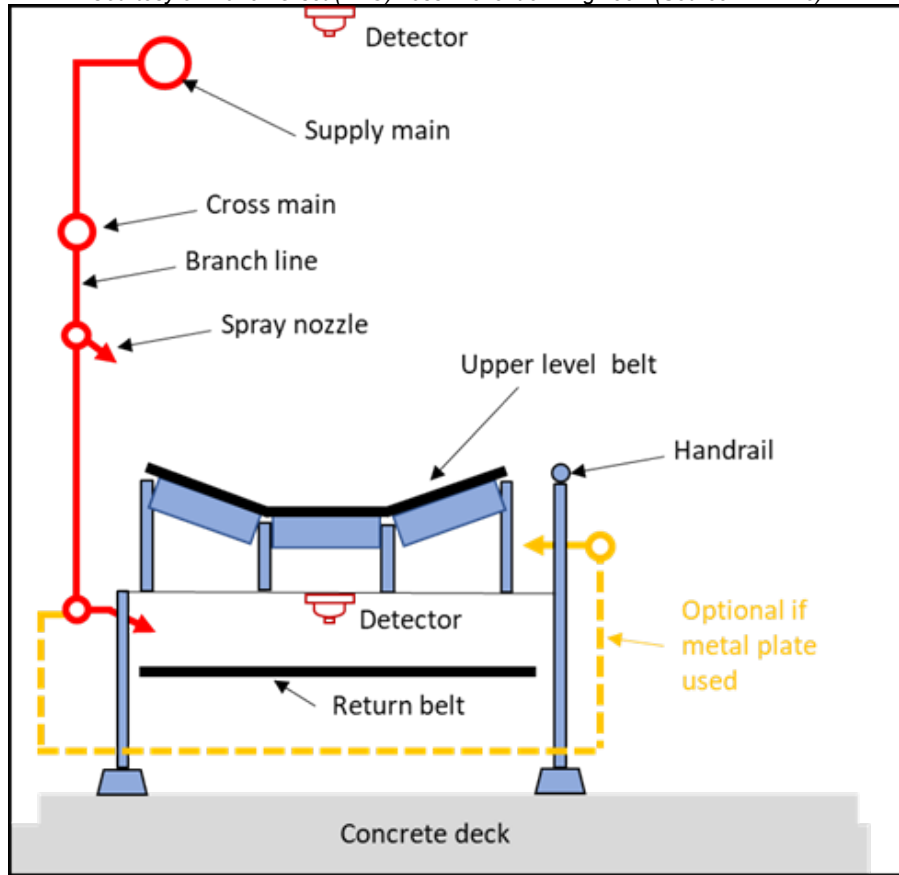

Typical conveyor belt protection (as per NFPA 15)

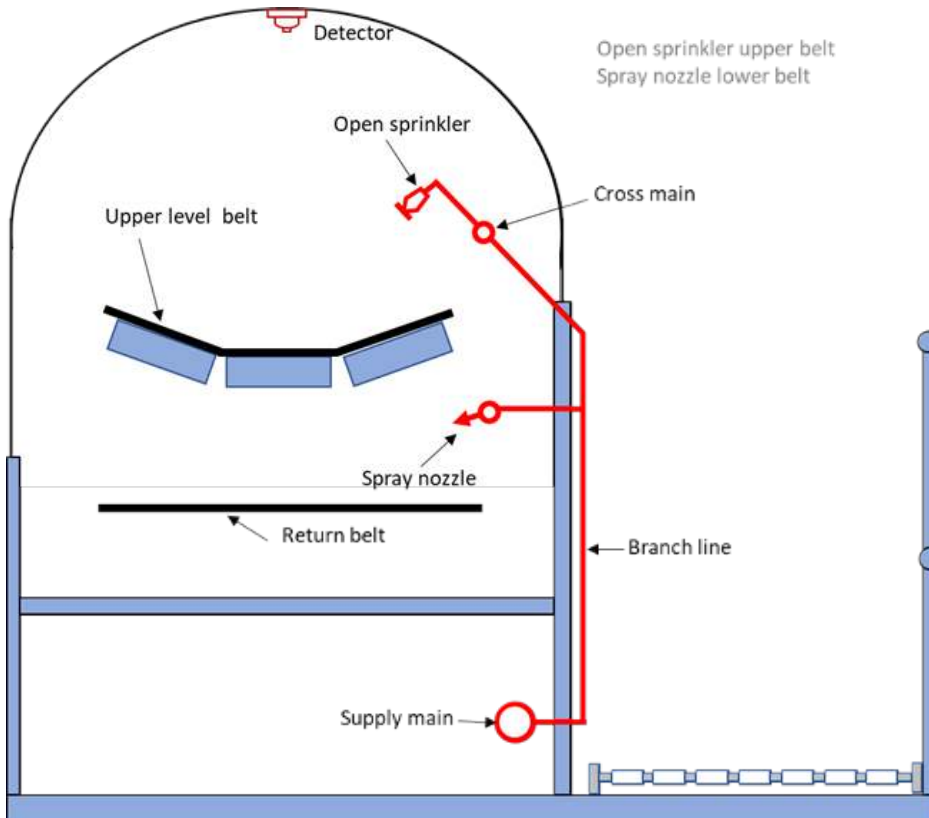

Typical hooded conveyor belt protection (as per NFPA 15)

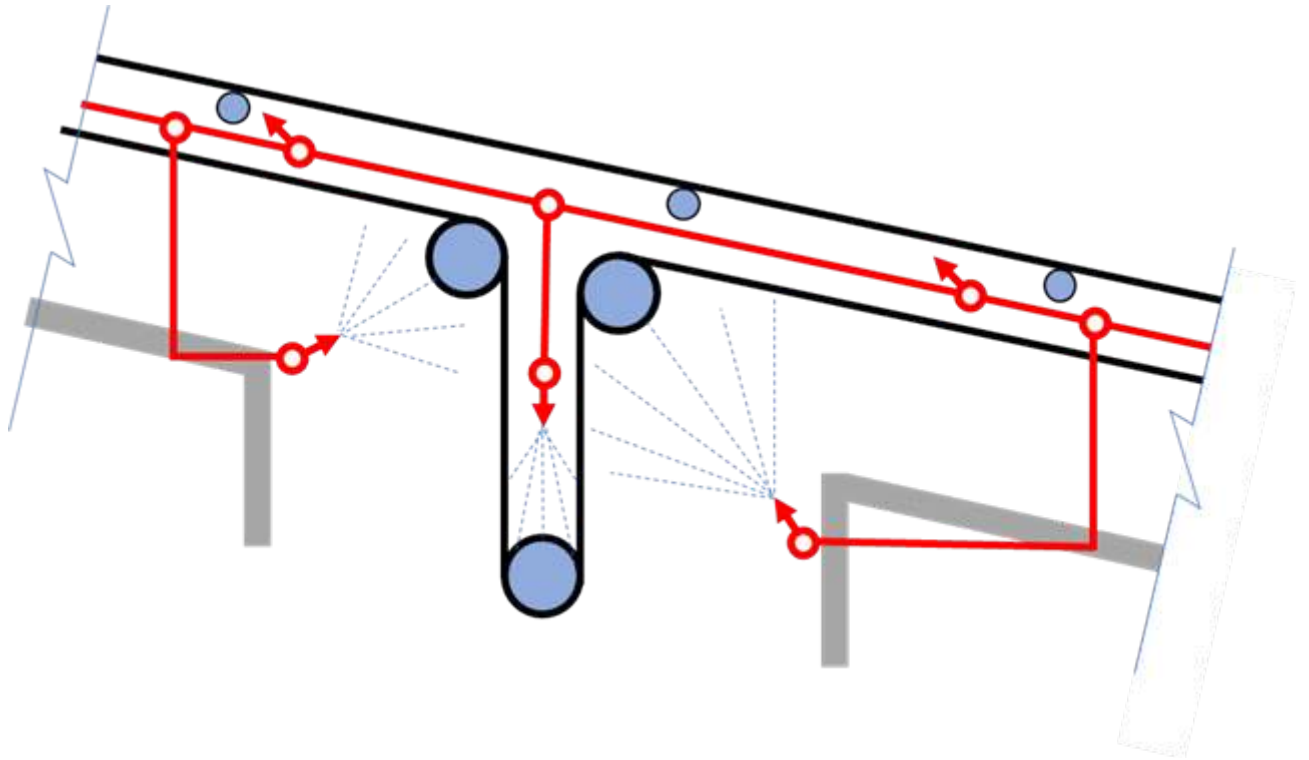

Elevation of typical take-up roller protection (as per NFPA 15)

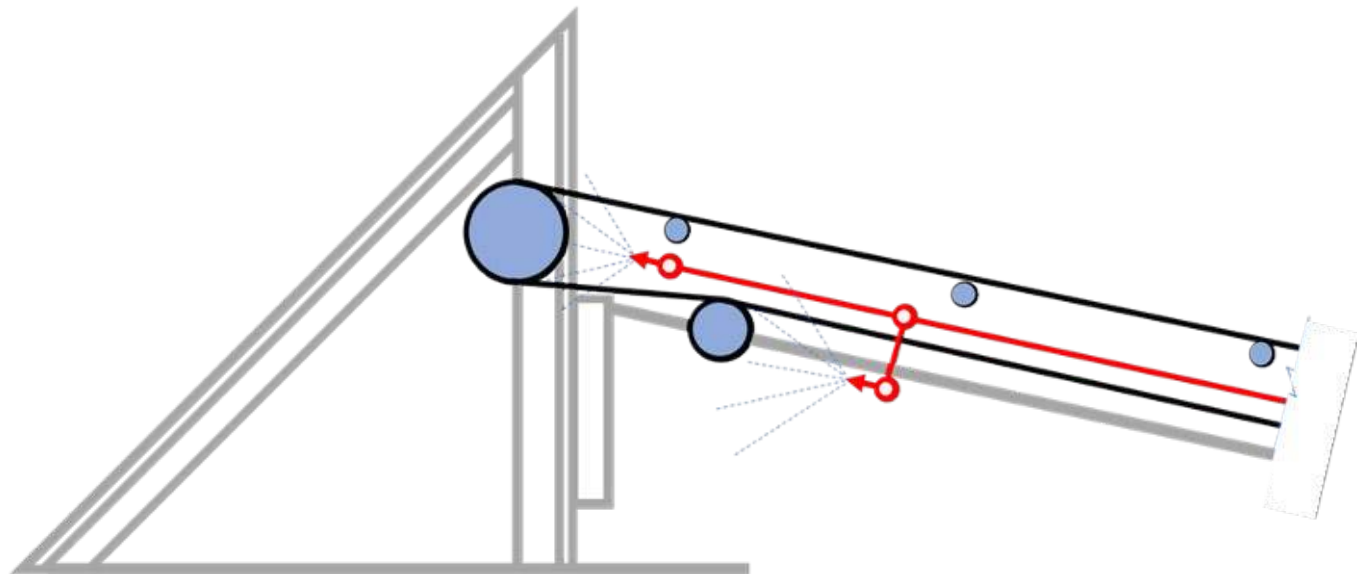

Elevation of typical end roller protection (as per NFPA 15)



10. COOLING TOWER

The impact on production of a potential total loss of a cooling tower set should be investigated. The following solutions A) or B) should be considered in detail for mitigating the loss:

A) **Contingency Plan:** a Contingency Plan should be developed (in case of the loss of a cooling tower set), identifying process-cooling alternatives, vendors and/or manufacturers or locations where entire sets are available.

or:

B) **Protection:** in case the above Contingency Plan is not acceptable from a Business Interruption standpoint, critical cooling towers (having a direct impact on production) should be adequately protected with approved sprinkler protection, as per NFPA 214/FM Global Data Sheets 1.6. All material and equipment should be approved and/or listed. The project should be reviewed by a qualified Fire Protection Engineer familiar with NFPA standards. All alarms should be relayed to a constantly attended location. This protection should be fed from an adequate and reliable Fire Water supply.

Comment:

The study should include the loss of an entire set of cooling towers, comprising several cells without fire separation (i.e. 40 m).

Cooling towers are usually made of combustible material such as FRP hoods, shells and packing. If there are multiple cells on the same set, even with a concrete shell and walls, the fire would be able to spread to the hood or the front or bottom openings.

Several fires during maintenance periods in the cooling tower (dry conditions) are recorded each year. The electrical failure of drivers and overheating, friction of the fan on the hood and lighting are also serious sources of ignition.

Due to a relatively fast fire spread, safe and efficient manual firefighting would be virtually impossible.

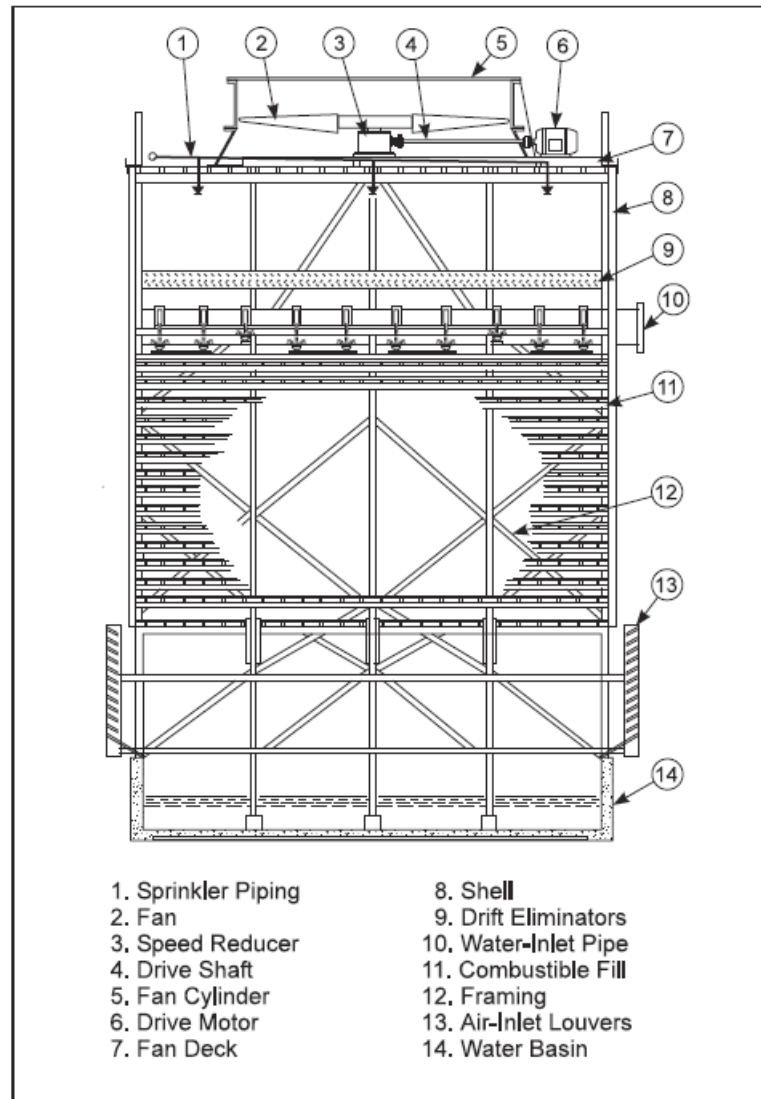

Fig. 1. Typical cross section of a counterflow induced-draft cooling tower

Minimum recommended density, as per FM Global Data Sheets 1-6:

- For cementitious fill and a combustible fan deck: wet pipe / dry pipe of 6 mm/min (0.15 gpm/ft²)
- For a combustible fan deck: wet pipe / dry pipe of 14 mm/min (0.35 gpm/ft²)
- For combustible fill & fan deck: deluge, 20 mm/min (0.50 gpm/ft²)

Minimum rate of application, as per NFPA 214:

- Deluge, under the fan decks, 20.4 mm/min (0.50 gpm/ft²) including the fan opening.

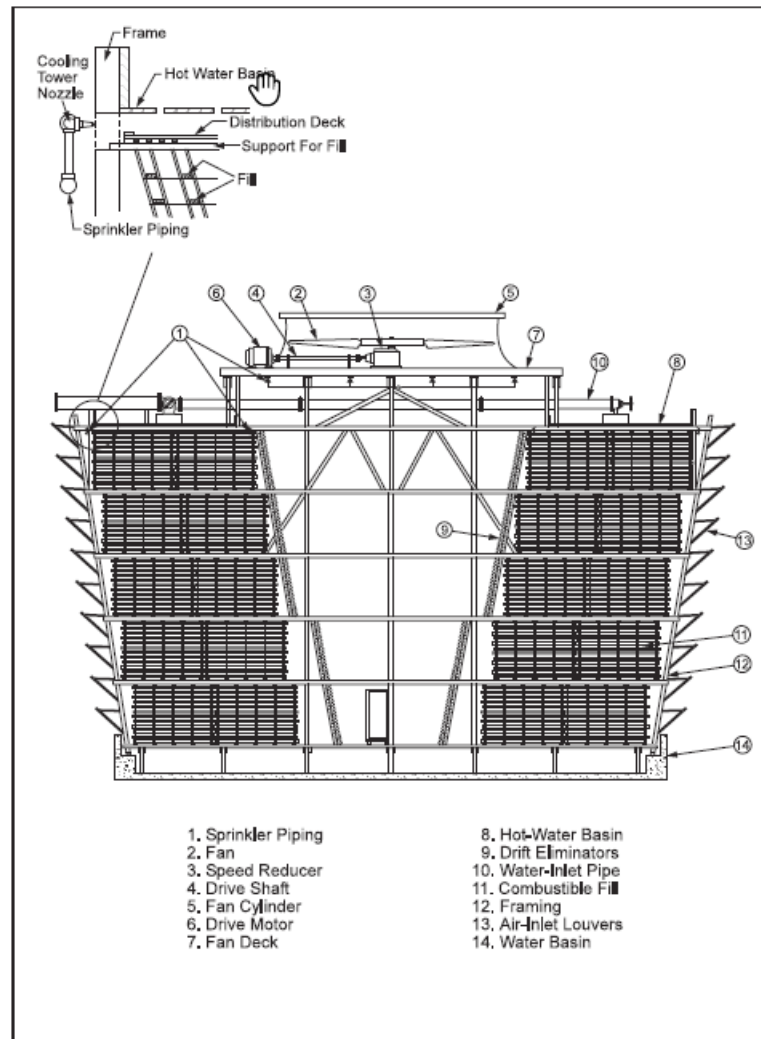

Fig. 2. Typical cross section of a crossflow induced-draft cooling tower (open hot water basin)

Minimum recommended density, as per FM Global Data Sheets 1-6:

- For a combustibile fan deck and fill: deluge, 14 mm/min (0.35 gpm/ft²)
- Without a distribution deck below the hot water basin: deluge, 20 mm/min (0.50 gpm/ft²) with a minimum end-head pressure of 170 kPa (25 psi).

Minimum rate of application, as per NFPA214:

- Deluge, under the fan decks, 13.45 mm/min (0.33 gpm/ft²) including the fan opening
- Deluge, over the fill area, 20.40 mm/min (0.50 gpm/ft²) including the fan opening

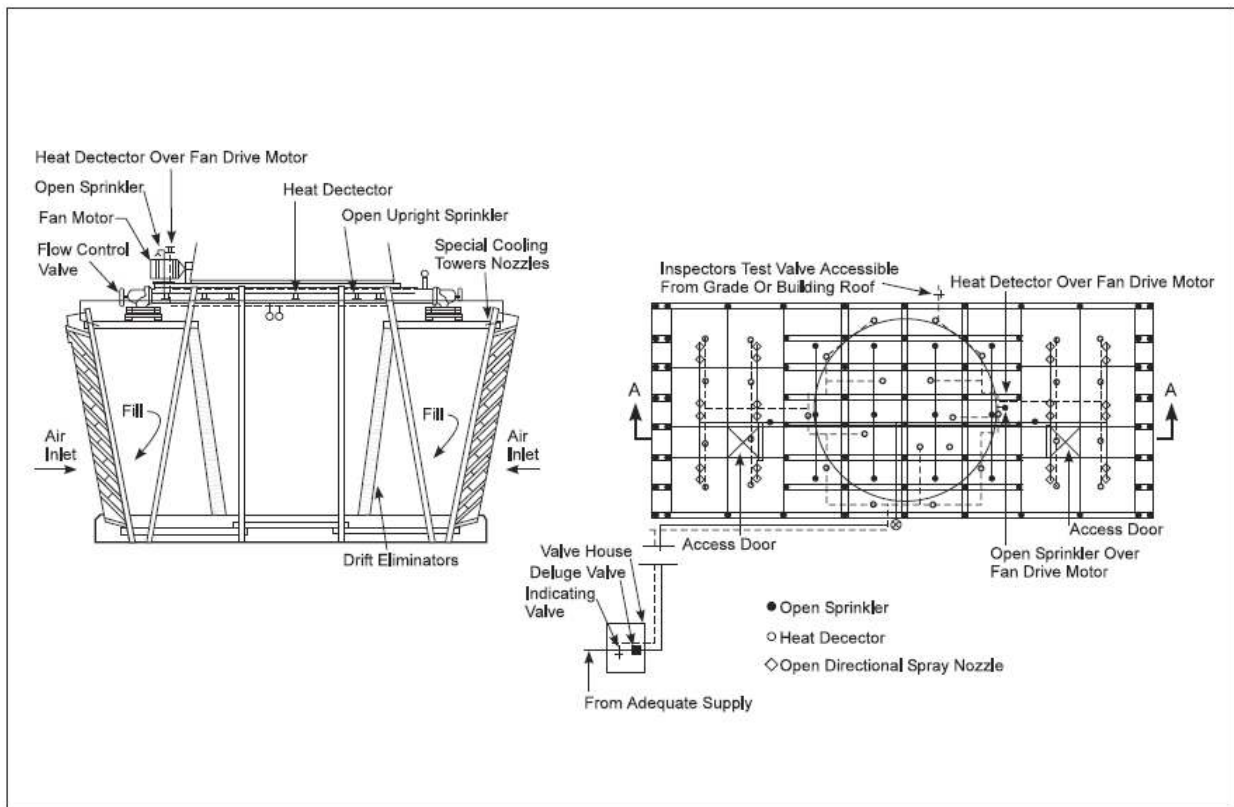

Fig. 3. Typical deluge fire protection arrangement for crossflow cooling towers

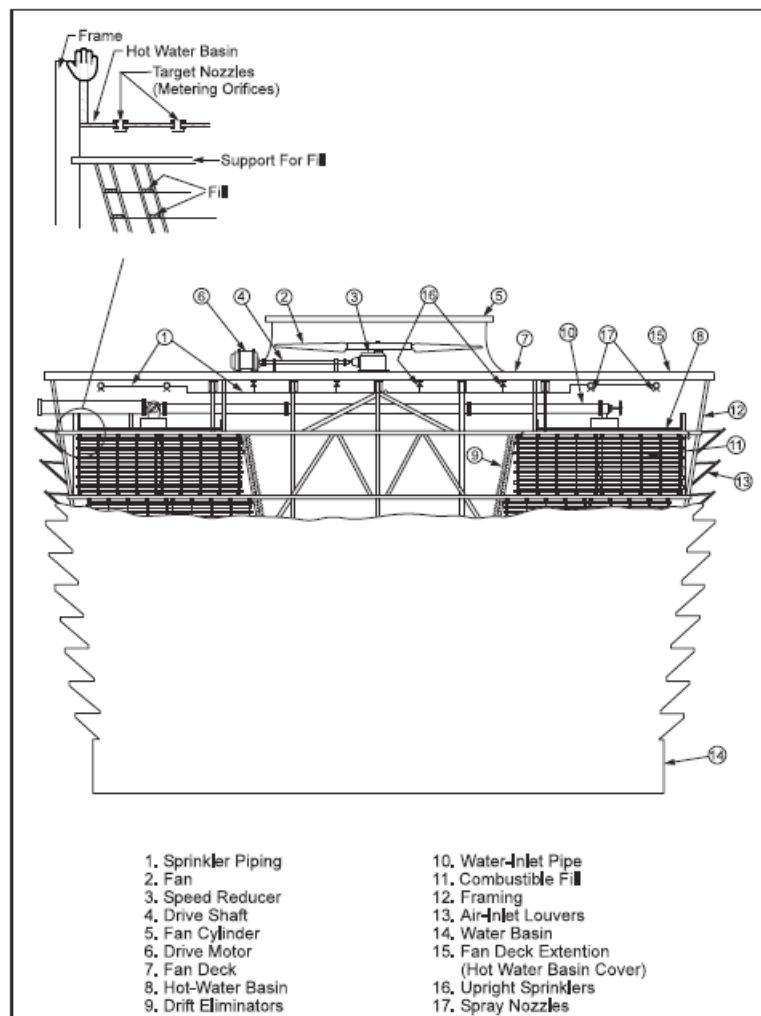

Fig. 4. Typical cross section of a crossflow induced-draft cooling tower (covered hot water basin)



Minimum recommended density, as per FM Global Data Sheets 1-6:

- For combustible fill: deluge, 20 mm/min (0.50 gpm/ft²) with a minimum end-head pressure of 170 kPa (25 psi)
- For a noncombustible fan deck extension: deluge, wide angle nozzles -180° water spray- 20 mm/min (0.50 gpm/ft²)
- For a combustible fan deck extension: deluge, wide-angle nozzles -16 mm/min (0.40 gpm/ft²) and additional nozzles on the underside of the fan deck extension - 4 mm/min (0.1 gpm/ft²)
- For noncombustible fill: wet / dry pipe, 8 mm/min (0.20 gpm/ft²) with a minimum end-head pressure of 170 kPa (25 psi)

11. HYDRAULIC / LUBRICATING GROUPS

Hydraulic oil might very well have a high flashpoint (320°C) but it can definitely burn. Adequate physical protection devices should be provided as follows:

A) All areas housing hydraulic and/or lubrication groups using 380 L or more of fluids under pressure should be provided with:

- Sprinkler protection for the areas containing these hydraulic / lubricating groups, installed in accordance with NFPA. All material and equipment should be FM-approved and/or UL-listed. All alarms, perturbations and supervisory signals should be relayed to a constantly attended location. This protection should be fed from an adequate and reliable Fire Water supply. The project plans should be reviewed by a qualified Fire Protection Engineer familiar with NFPA standards.

and

- All hydraulic / lubricating pumps should be interlocked to the sprinkler system in order to automatically shut down all machines operating in the fire area (when a safe shutdown is possible without lubrication)
- or
- A low oil pressure switch should be located within each reservoir, arranged to shut down the machine.

B) All areas housing hydraulic and lubrication groups using less than 380 L of fluid under pressure but still exposing the adjacent facilities should be:

- Sprinkler-protected in accordance with NFPA. This can consist of sprinkler heads installed under a noncombustible canopy above the hydraulic / lubricating group. All material and equipment should be FM-approved and/or UL-listed. All alarms, perturbations and supervisory signals should be relayed to a constantly attended location. This protection should be fed from an adequate and reliable Fire Water supply. The project plans should be reviewed by a qualified Fire Protection Engineer familiar with NFPA standards

and

- The hydraulic / lubricating pumps should be interlocked to the sprinkler system in order to automatically shut down in case of fire water discharge (when a safe shutdown is possible without lubrication)



C) As an alternative to points A & B above:

- a. Use a nonignitable liquid that will not sustain combustion even when in the form of a spray (e.g. water).

or

- b. Use FM-approved less-combustible fluids when possible. This should be investigated with the equipment manufacturer. FM-approved industrial fluids present a minimal fire hazard and do not, by themselves, necessitate fire protection features for the equipment or building. The need for automatic sprinkler protection should be determined based on the surrounding occupancy's combustible load and the continuity of the combustible (e.g. combustible construction, cable trays, storage of combustible goods).

or

- c. When it is not possible to use a nonignitable liquid or an FM-approved industrial fluid, use a fluid with as high a flashpoint as possible and provide additional safeguards to adequately protect the hazard, as recommended in point A and B above (i.e. sprinkler systems and interlocks).

D) **Lubricating groups at atmospheric pressure or under low pressure (2-4 bar)** present a minimal fire hazard and do not, by themselves, necessitate fire protection features for the equipment when enough clearance is provided all around (i.e. 15 m radius). If the clearance is less than 15 m, the need for automatic sprinkler protection should be determined based on the surrounding occupancy's combustible load, continuity of the combustible (e.g. combustible construction, cable trays, storage of combustible goods), exposure to surrounding equipment (e.g. process / utility equipment) and access for manual firefighting (e.g. elevated mezzanines with 3D fire potential, oil cellars).

The sprinkler protection should be in accordance with NFPA. This can consist of sprinkler heads installed under a noncombustible canopy above the hydraulics. All material and equipment should be FM-approved and/or UL-listed. All alarms, perturbations and supervisory signals should be relayed to a constantly attended location. This protection should be fed from an adequate and reliable Fire Water supply. The project plans should be reviewed by a qualified Fire Protection Engineer familiar with NFPA standards

Comment:

In the case of a hose rupture, combustible oil would be sprayed over the area and could easily be ignited by contact with a hot surface or another ignition source. The resulting fire is usually torch-like, with a very high rate of heat release.

Causes of Oil Release: High-pressure pipes with welded and threaded joints, steel and copper tubing and metal-reinforced rubber hoses are used to carry oil to the various units under pressure. The failure of piping, failure of valves and gaskets or fittings, ripping out of copper and steel tubing from fittings, and rupture of flexible hoses have been the principal causes of oil release from the system. A lack of adequate support or anchorage, preventing vibration or pipe movement, has been a factor in these failures. Repeated flexing and abrasion of rubber hoses against other hoses or parts of machines have created weak spots, which eventually resulted in rupture. Tubing under pressure has released oil when accidentally cut by welding torches or stepped on during maintenance procedures.

Safe and efficient manual firefighting of oil on fire (especially within a confined space) will be virtually impossible.

Spray fires cannot be extinguished by automatic sprinklers, so this high-heat release fire will continue until the flow of liquid is shut down. This is the most efficient way of preventing the release of combustible fluid (fuel source for the fire) and then sprinklers may be used for controlling the fire in its early stages of development.

FM-approved industrial fluids have been developed to replace petroleum-based oils in all types of hydraulic systems. FM-approved industrial fluids present a minimal fire hazard and do not, by



themselves, necessitate fire protection features for the equipment or building. These fluids, if sprayed onto very hot surfaces, can result in a flaring fire. However, these fluids should stop burning when they flow away from the hot surface. Loss experience indicates that properly maintained systems with FM-approved hydraulic fluids significantly reduce the extent of damage caused by a fire as compared to systems with petroleum-based oils.

Follow procedures recommended by the manufacturers of the FM-approved fluid and of the hydraulic equipment in converting machines from ignitable liquids such as mineral oil. Consult the manufacturers to address issues such as draining the old fluid from the system; replacing seals, gaskets, packing and filters; filling the system with the new fluid and monitoring equipment and operating conditions (e.g., temperatures, inlet and outlet pressures, flow rates, fluid viscosity and stability, corrosion, etc.).

Warning: some hydraulic fluids are available that are described as “less flammable.” These fluids are not considered to be equivalent to FM-approved industrial fluids in terms of the fire hazard they present. The methodologies used in validating these other fluids as “less flammable” are inconsistent and not fully understood. The actual fire hazard that these liquids present is unknown, and they may still sustain a high heat-release rate spray fire despite their designation.

An Ignitable Liquid comprises any liquid or liquid mixture that is capable of fueling a fire, including flammable liquids, combustible liquids, inflammable liquids or any other term for a liquid that will burn. An ignitable liquid is one that has a fire point.

High water-content fluids may not exhibit a fire point. However, high water-content fluids can still burn in the form of an atomized spray. FM Approval Standard 6930 also includes criteria to evaluate fluids without a fire point for approval. Please refer to FM Global Data Sheets 7.98 Hydraulic Fluids, Appendix C2 for more details.

12. HEAT TRANSFER FLUID / MEDIA (HTF/HTM)

The following points should be investigated in detail:

A) **Construction & Location:** Ensure construction (including electric equipment classification) and space separation of the detached building is in accordance with Data Sheet “7-32, Flammable Liquid Operations”.

B) **Provide automatic sprinkler protection** (EH2*) throughout all building areas subject to a heat transfer fluid spill fire. This includes the vaporizer or heater room, user room and areas containing heat transfer fluid piping. An automatically actuated deluge sprinkler system is an acceptable alternative to an automatic sprinkler system.

(*) There is no dedicated NFPA standard for HTF. As a result, if we consider NFPA13, occupancy class EH2 refers to the use of HTH heated above its flashpoint or it refers to the vaporizer (i.e. Flammable liquid spraying”). Occupancy class EH1 could also be considered for HTF that is NOT heated above its flashpoint or if the vaporizer is not taken into consideration (i.e. “Combustible hydraulic fluid use areas”). For finetuning the required density and surface of application, please refer to FM Global data sheet “7-99 Heat Transfer by Organic and Synthetic Fluids”.

C) **System Instrumentation & Interlocks:** Ensure that measuring instrumentation and interlocks are provided to sound an alarm and automatically shut down the fuel source to the HTF heater or vaporizer when any of the following conditions are detected:

- 1) Low HTF flow through the heat exchange tubes of the heater, measured at the discharge (i.e., when flow velocity is below that required for turbulent flow)
- 2) High HTF temperature or pressure at the heater or vaporizer outlet (Note: Ensure the high temperature interlock is set at or below the HTF manufacturer’s maximum recommended bulk fluid temperature).



- 3) Low pressure at the heater or vaporizer outlet or elsewhere in the system (Note: This interlock may require a by-pass to allow for conditions at startup.)
- 4) High heat exchanger tube temperature or high film temperature, as measured by thermocouples at the surface of the tubes (optional) (Note: Ensure the set point is at or below the HTF manufacturer's maximum recommended film temperature.
- 5) Low fluid level in the expansion tank
- 6) Low vaporizer liquid level
- 7) High temperature of liquid entering the heater or vaporizer (optional if 2). is provided)
- 8) Sprinkler system flow in any area containing HTF equipment or piping
- 9) High temperature at bridge wall (optional)

D) Fire Interlock & Isolation: Interlock the heat transfer system to stop the circulation of fluid throughout the system and to isolate major piping segments in the event of a fire. To accomplish this, make sure the interlock is set up to actuate either in the event of sprinkler system operations or abnormally low pressure in the heat transfer system, or upon operation of a heat detection system using FM-approved and or UL-listed detectors.

Comment:

Heat Transfer systems using organic and synthetic fluid are responsible for numerous losses in the industry. As a result, adequate safeguards and fire protection should be provided.

HTM boilers and loops may contain several cubic meters of oil.

Note that some Heat Transfer Fluids (i.e. Therminol 66, Fp^o170-184) operate with a flash point at about 200°C, max 250°C. Areas such as boiler rooms should be equipped with intrinsically safe electrics (ATEX).

Emergency drain tanks designed for containing the entire content of the loop should be provided and adequately protected with sprinklers. Some form of secondary containment designed to contain 120% of the full content of the tank (of which 20% is fire water) should be provided.

13. PASTE PLANT FIXED FIRE PROTECTION

The following points should be considered in detail:

- 1) The Fixed Fire protection of the Paste Plants should be in accordance with FM Global Data Sheets' 7-64/13-28 requirements.
- 2) All water-based fixed fire protection systems and manual firefighting should be supplied by an adequate and approved Fire Water Network and Fire Water Supply, as per NFPA.
- 3) All equipment should be FM-approved and the installation should be in accordance with NFPA.
- 4) Project plans should be reviewed and installation acceptance tests should be conducted by a qualified Fire Protection Engineer familiar with FM Global Data Sheets and NFPA standards.
- 5) Provide automatic fire protection in anode-baking oven fume exhaust systems extending from the ring main outlet to the Fume Treatment Center inlet, in accordance with Data Sheet 7-78, Industrial Exhaust Systems. Extend protection upstream to the ring main if housekeeping inspections reveal combustible deposit formation.



14. AIR COMPRESSOR

Courtesy of Franck Orset (FPO) Loss prevention Engineer:

The Hazard

Many air compressor explosions and fires originate from oil and carbon deposits in the compressor systems.

Excessive deposits in the system are the result of over-lubrication, use of unsuitable lubricants or dirty and/or chemically contaminated suction air.

Under conditions of high temperature and pressure, contaminants and oily carbon deposits may oxidize and ignite spontaneously, creating an ignition source for vapors and residues. Glowing particles may be carried to a point in this system where there is a combustible or explosive mixture. Localized heating may weaken the equipment walls to the point of failure.

Another important cause of air compressor fires and explosions is excessively high discharge temperatures.

Abnormal temperatures are caused by recompression due to leakage through faulty valves or to blow-by in double-acting cylinders, by inadequate cooling water jackets and after-coolers, caused by high cylinder pressure due to severe restriction of discharge lines by deposits, or by mechanical friction or broken compressor parts.

Other air compressor fires and explosions have originated in the compressor drive motor, controls or associated electrical equipment. A few fires have been caused by friction due to slippage of drive belts or pulleys; by external ignition sources that involved oily residues; by solvent cleaners or combustibles in the vicinity of the compressor that in some cases heated the compressor system to a point where internal carbon deposits ignited; and by oily lint or other combustibles in contact with the outside surfaces of hot compressor parts.

The frequency of fires in oil-flooded rotary-screw compressors is much greater than in other air compressors.

STANDARD

Location

Air compressors should be located in noncombustible buildings or cut-off rooms. No other equipment or storage should be located in the same room.

Ventilation

Rotary-screw compressor air-receiver vents should discharge to a safe location because the vented air/oil mixture may be flammable.

Air intakes should be located away from sources of flammable vapors, gas, steam, dust or other contaminants. Intake-air filters should be provided to remove suspended solids.

Fire protection

A sprinkler protection is only required if one of the following conditions exists:

- The room or building is of combustible construction
- An adjacent occupancy is combustible or represents a fire hazard
- Compressors have an external lubrication system with a capacity above 380 L (100 gal.) or a flow rate exceeding 95 L/min (25 gpm). If there are multiple compressors, the capacity should be considered as the aggregate total for all compressors within 8 m (25 ft).

The sprinkler protection should be designed to deliver a minimum density of 8 mm/min (0.2 gpm/sq ft) over the postulated oil spill, or compressed air foam, with a maximum area of application of 280 m² (3000 sq ft), with K 80 (K 5.6) spray sprinklers rated at 141°C (286°F) - or a higher density if the adjacent occupancy/storage within the room requires it.



If the protection is only over the units (no need to protect the rest of the room), then the sprinkler protection should extend at least 6 m (20 ft) beyond the units (the compressor and any part of the oil system).

If sprinkler protection is omitted, consideration should be given to providing heat-actuated detectors interlocked to an automatic shutdown for high value units or areas.

15. FUEL LINE SAFETY COMBUSTION CONTROL

An automatic starting sequence including a purging cycle, and inerting of the combustion chamber and ignition interlock should be provided.

The safety combustion controls on the fuel line should include modern safety devices such as (but not limited to): high and low-pressure switches, Safety Shut-Off Valves (SSOV) and Valve Seals Over Travel Interlocks (VSOI). This should be in accordance with NFPA85 “Boiler and Combustion Systems Hazards Code” as summarized below:

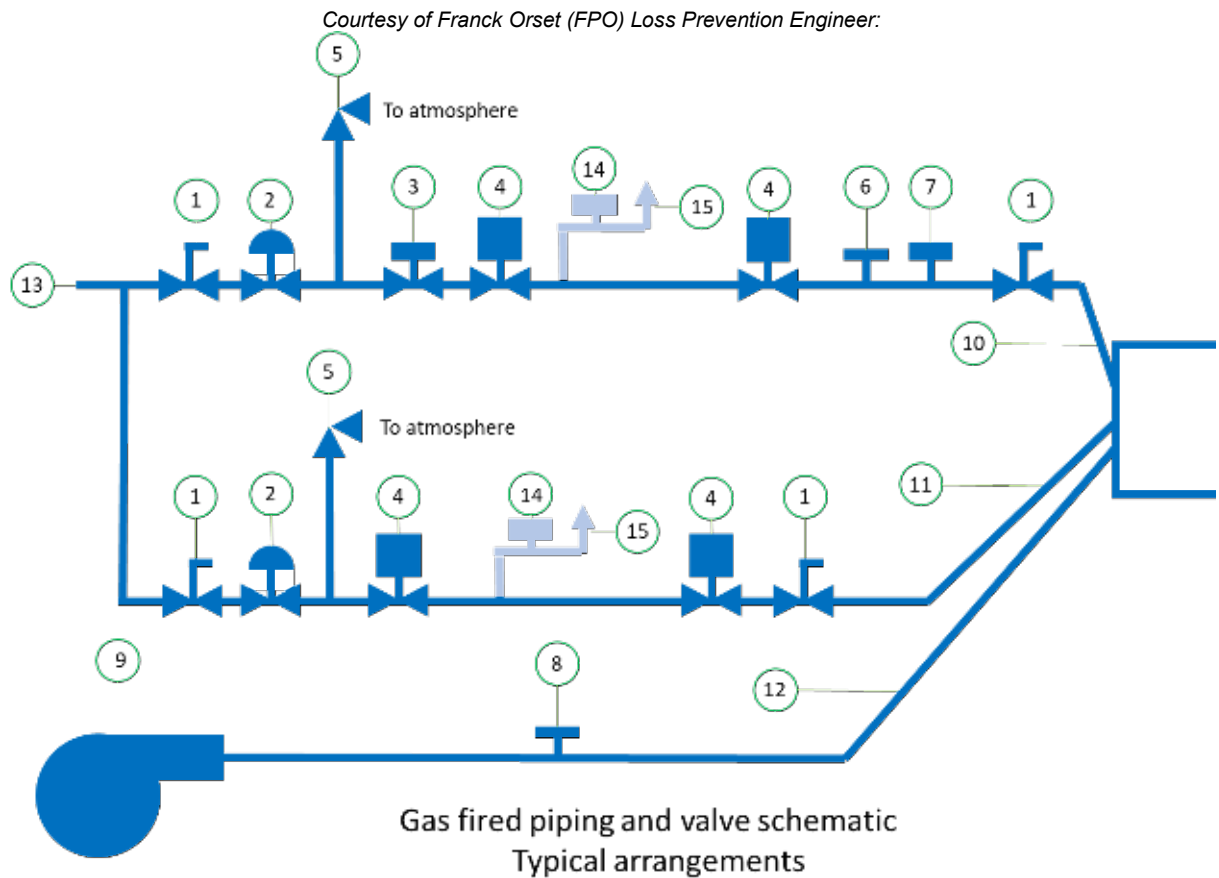

- | | | |
|-------------------------------|-----------------------------------|--|
| 1. Manual cock | 6. Test connection | 11. Igniter |
| 2. Pressure regulator | 7. High pressure gas switch | 12. Combustion air |
| 3. Low gas pressure switch | 8. Combustion air pressure switch | 13. Gas supply |
| 4. Safety shutoff valve | 9. Combustion air blower | 14. Normally open valve (see note) |
| 5. Relief valve (if required) | 10. Main burner | 15. Vent line to atmosphere (see note) |

Note: the vent valve and vent line to atmosphere are required by NFPA on units with a greater than 3.7 MW (12.5 mBtu/h) input.



Note 1: when a modulating valve is provided on the main gas line, it should be located between the second safety shutoff valve and the manual cock at the burner. An alternate location is between the gas pressure regulator and the first safety shutoff valve.

Note 2: igniters of 75 kW (250,000 Btu/h) input or greater, with gas pressure regulated separately from the main burner gas supply, should be provided with high and low gas pressure switches located on the same relative positions as on the main gas line.

Note 3: the vent valve with a vent line to atmosphere is an additional safety feature providing increased protection.

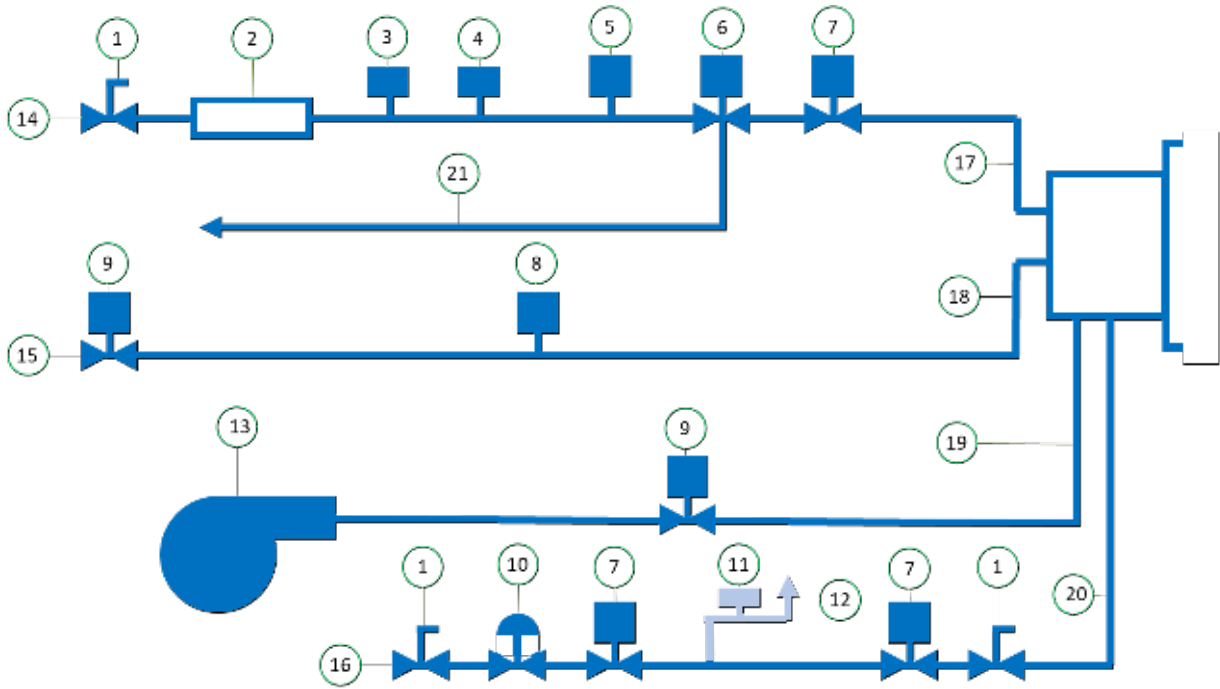

Oil fired piping and valve schematic
Typical arrangements

- | | | |
|-------------------------------------|---|--------------------------|
| 1. Manual cock | 9. Combustion air pressure switch | 15. Atomizing steam/air |
| 2. Preheater | 10. Pressure regulator | 16. Igniter gas supply |
| 3. Low oil temperature switch | 11. Normally open vent valve (see note) | 17. Main burner |
| 4. High oil temperature switch | 12. Vent to atmosphere (see note) | 18. Atomizing medium |
| 5. Low oil pressure switch | 13. Combustion air blower | 19. Combustion air |
| 6. Circulating oil valve | 14. Oil supply | 20. Igniter |
| 7. Safety shutoff valve | | 21. Oil return to supply |
| 8. Atomizing medium pressure switch | | |

Note: the vent valve and vent line to atmosphere are required by NFPA on units with a greater than 3.7 MW (12.5 mBtu/h) input.



Suggested testing schedule

This proposed testing schedule emphasizes preventive maintenance, which is imperative for continuous safe operations. As equipment and devices age, the need for testing becomes more important.

Equipment	Hourly	8-hourly	Daily	Weekly	Monthly	Semi-annual	Annual
Blow down low-water control		X					
Clean out low-water control						X	
Test and recalibrate boiler gauges							X
Check water column	X						
Blow down water column		X					
Test CO ₂ or O ₂				X			
Clean out stack							X
Flame condition	X						
Flame-supervisory control			X				
Gas-pressure switch				X			
Oil-pressure switch				X			
Oil-temperature switch				X			
Excess-steam-pressure switch					X		
Atomizing-steam air switch				X			
Forced-draft-air switch				X			
Induced-draft-air switch				X			
Gas safety shutoff valves				X			
Gas vent valves				X			
Oil safety shutoff valves				X			
Purge timing				X			
Damper limit controls				X			
Modular limit controls				X			
Fuel and air linkage					X		

16. HAZMAT & AEROSOLS & COMPRESSED GAS CYLINDERS

- Chemicals should be stored in a dedicated, adequately sprinkler-protected building, with retention and/or drainage to a tank. The use of approved and adequate safety cabinets inside the building dedicated to some hazmat hazards (i.e. separation of acid and base solutions, oxidizers and flammables) is also a good practice.
- Flammable liquid rooms' requirements:
 - a) The room should be cut off from other areas by a 90min. (F90)-rated wall and ceiling. The door opening should be protected with a 90min.-rated self-closing door (T90).
 - b) All electrical equipment and wiring should be explosion-proof.
 - c) Grounding and bonding facilities should be provided.
 - d) The walls should be liquid-tight where they meet the floor. A 100 mm curb should be provided at the doorway. Special drains or trenches should be provided to remove liquids to a safe location under emergency conditions. The system should have sufficient capacity to remove the expected discharge from the sprinkler system (if installed) and hose streams.
 - e) Low-point continuous mechanical ventilation should be provided with a suction inlet within 0.3 m of the floor. It should be designed to exhaust a minimum of 0.3 m³/min per m² of floor area.
- Aerosols should be stored in metal cabinets or be fenced in. In case of fire, the exposed aerosols would explode and would allow the fire to spread into the building.



- Compressed gas cylinders should be chained (or otherwise restrained) upright to a wall, cylinder truck, cylinder rack or other substantial structure.
- Acetylene cylinders should be stored away from oxygen cylinders. Oxygen cylinders should be separated from fuel gas cylinders or other combustible materials by a minimum distance of 6 m or by a barrier of noncombustible material at least 1.5 m high with a fire resistance of at least ½ hour.

17. OVERHEAD CRANES

Courtesy of Franck Orset (FPO) Loss Prevention Engineer

Overhead cranes should not be positioned above critical equipment (GIS, turbine...) when not in operation.

Smoke detection systems should be provided, as well as provision of portable fire extinguishers, for the electric cabinets of the main overhead cranes (turbine hall and reactor building as a minimum).

Smoke detection should be provided in the battery room, machinery room, elevator shaft, elevator machine room, transformer room, transformer blower room, near main electrical disconnects and group cable trays, and in any similar areas not having fixed protection.

The alarm must sound in the control cab and at the base of the crane.

The alarm should also be transmitted to the Main Control Room.

Upon activation of the fire detection system, the procedure should include positioning the crane in a safe area (not above critical equipment such as the fuel pool or the turbine equipment), accessible for manual firefighting. Then, the electrical supply should be shut down to limit the fire activation on electrical equipment.

The need to provide an automatic fixed gas protection system should be considered if, in case of fire, the access is deemed too difficult (or delayed) for manual firefighting means.

In that case, an automatic gaseous fire protection system should be provided in the control room, cable room and cabinets, switchgear cabinets and other similar areas where combustibles are present.

If a time-delay interlock needs to be provided on the system, set it to the minimum required for the safe evacuation of personnel.

Note that situations where electrical cabinets are located inside the beam of the crane (bridge beam) are more problematic than when the electrical cabinets are located outside (in terms of fire damage).

There are further disadvantages to having the electrical cabinets located inside:

- Smoke is not easily detected by operators (it remains inside the beam).
- Even with a limited amount of combustible material involved in a fire inside the beam, the heat released can have serious adverse effects on the steel structure of the crane (a phenomenon similar to a “pizza stove” effect).



18. CONTROL ROOM

Courtesy of Franck Orset (FPO) Loss Prevention Engineer

Construction/Safe Separation:

The Control Room should be separated from adjacent areas of the plant by floors, walls, ceilings and roof assemblies with a minimum fire resistance of 3 hours.

Peripheral rooms in the control room should be equipped with a water-based fixed fire protection system and separated from the main control room by a noncombustible construction with a minimum fire rating of 1h.

There should be no kitchen in the same fire area of the Main Control Room (if a kitchen is directly accessible from the Main Control Room, it should be fire-separated, equipped with a self-closing fire door and equipped with a smoke or thermal fire detection system).

Combustible construction materials should not be used in the Control Room. The use of decorative wood paneling and plastic grid ceilings should be avoided.

Raised floors and suspended ceilings should be avoided, or the smoke detection system should be extended to these areas.

When raised floors are present, access to the space under raised floors should not be restricted and tools necessary for access (such as suction cups) must be clearly marked and readily available in the computer room.

Fire detection:

A smoke detection system should be provided in the Control Room to detect fires at their incipient stage. Air sampling-type detection systems are recommended.

Smoke detection systems should be provided in the Control Room complex and the electrical cabinets and consoles (and under the raised floor or above the false ceiling, if provided and cables are present). Cabinets containing electric and electronic equipment should have detectors installed inside.

Fire protection:

Automatic fire protection is not necessary in a Control Room that is constantly attended (24/7).

Automatic fire protection systems might be recommended for adjacent rooms such as the computer room or adjacent electrical and relay rooms.

Automatic fire protection might also be recommended under raised floors or above false ceilings when large concentrations of cables are present.

Ventilation:

Automatic fire dampers that close when the smoke detection system is operating, and fire suppression systems should be provided for ventilation system openings between the Control Room and peripheral rooms.

The outside air intakes for the control room ventilation system should be provided with smoke detection capabilities to trigger the alarm in the Control Room and enable the manual isolation of the control room ventilation system (to prevent smoke from entering).

Venting of smoke produced by a fire in the Control Room, by means of a normal ventilation system, is acceptable if provision is made for isolating the recirculation portion of the normal ventilation system. Manually operated venting of the control room should be available to the operators.

Cables:

All cables entering the Control Room should terminate inside the Control Room. No cabling should be routed through the Control Room from one area to another. Cable openings, through walls or floors, should be adequately sealed to avoid a fire spread from one side to the other.



Breathing Apparatus:

Breathing apparatus should be available with sufficient capacity to attain a safe shutdown.

Emergency Control Area:

A separate Emergency Control Area (ECA) should be available should the Control Room be unavailable. The ECA should be situated in a fire compartment separate from the Control Room.

There should be a safe access route from the Control Room to the ECA.

The smoke management system should ensure a habitable environment for the operators to safely transfer the Control Room to the ECA.

The ECA should contain all instrumentation and control equipment needed to achieve and maintain a hot shutdown. There should be full electrical isolation and fire separation from the MCRC.

Manual Firefighting:

There should be easy access to individual cabinets to facilitate the use of portable hand-held extinguishers.

Manual firefighting capabilities should be provided for fires originating within a cabinet, console or connecting cable, as well as for exposure fires involving combustible materials in the room area.

A suction cup to lift false floor tiles should be provided inside the Control Room if raised floors are located within the main control room and/or adjacent control computer room & electrical room.

Nonsmoking policy:

The Main Control Room should be a strictly non-smoking area.

A smoking corner, even well arranged, should NOT be allowed inside the Main Control Room.

19. WAREHOUSE

Commodity Class II (i.e. large metal parts in wooden crates or on wooden palettes) in non-combustible construction warehouses (i.e. single metal sheets, mineral wool-insulated panels) should be provided with adequate and approved Automatic Fire Alarm systems (i.e. smoke detectors, laser beams) as per NFPA. All alarms, perturbations and supervisory signals should be relayed to a constantly attended location (even when manned 24/7).

Adequate sprinkler protection as per NFPA13 should be provided for the following cases:

- Warehouses made of combustible construction material (e.g. PUR, PIR panels. Note that the use of EPS panels under the ceiling should be prohibited as there is no automatic fire protection solution)
- Spares and consumables exceeding class II Commodity Class, as per NFPA (e.g. cables and PVC insulation on wooden spools, rubber hoses, open-top plastic containers, PE wrapping rolls)



20. DUCT SPRINKLER PROTECTION

Courtesy of Franck Orset (FPO) Loss Prevention Engineer

STANDARD

Any portion of a piping/exhaust system having the potential for a combustible residue buildup on the inside, where the duct sectional area is greater than or equal to 480 cm² (75 in.²) - i.e. for pipes with a 250 mm (10 in.) diameter or larger - should be provided with an automatic extinguishing system inside the duct.

Sprinkler protection should also be provided in ductworks (for combustible ductworks of a sectional cross diameter of 250 mm (10 in.) or larger, and for smaller diameters whenever practical).

A separate indicating control valve should be provided for the sprinklers installed in the ductworks.

The sprinkler protection inside the exhaust ducts/pipes should meet the following requirements:

- The sprinkler protection should be designed over a maximum length of 30 m (100 ft), with a minimum flow of 114 L/min (30 gpm/min) per head at a minimum of 1 bar (15 psi) pressure, over the 30 m (100 ft) of duct (horizontal or vertical).
- Use 74°C (165°F)-rated sprinkler heads (or heads with a temperature rating at least 30°C (86°F) above the temperature of the environment inside the duct).
- One sprinkler should be located at the top of each vertical riser and at the midpoint of each offset. Additional sprinklers should be spaced on 7.3 m (24 ft) centers if the rise is greater than 7.3 m.
- Maximum spacing between sprinkler heads should be 3.7 m (12 ft) for horizontal ducts. The first sprinkler should be located no more than 1.7 m (6 ft) from the duct entrance.
- Sprinklers heads should be arranged in exhaust ducts containing baffles such that the sprinkler distribution pattern is not obstructed.
- To prevent the collection of paint on the sprinkler heads (which would delay activation), the heads should be covered with a cellophane bag having a thickness of 0.076 mm (0.003 in.) or less, or with a thin paper bag. This covering should be replaced frequently so that heavy deposits of residue do not accumulate.
- Sprinkler piping should be installed outside the ductwork and supported independently from the ductwork system.
- Access should be provided on the piping system to enable a regular check of the sprinkler heads. Flexible sprinkler fittings allow for easier inspection. See Figure 2 below.
- Automatic drains should be provided to eliminate extinguishing water and to prevent water accumulation in the duct or flow of water back to a process subject that could be damaged by water.
- If duct width or diameter is larger than 3.7 m (12 ft), an additional line of sprinklers, with the same spacing, should be provided inside the duct. For rounded ducts, the sprinkler lines should be positioned at 2 o'clock and 10 o'clock.

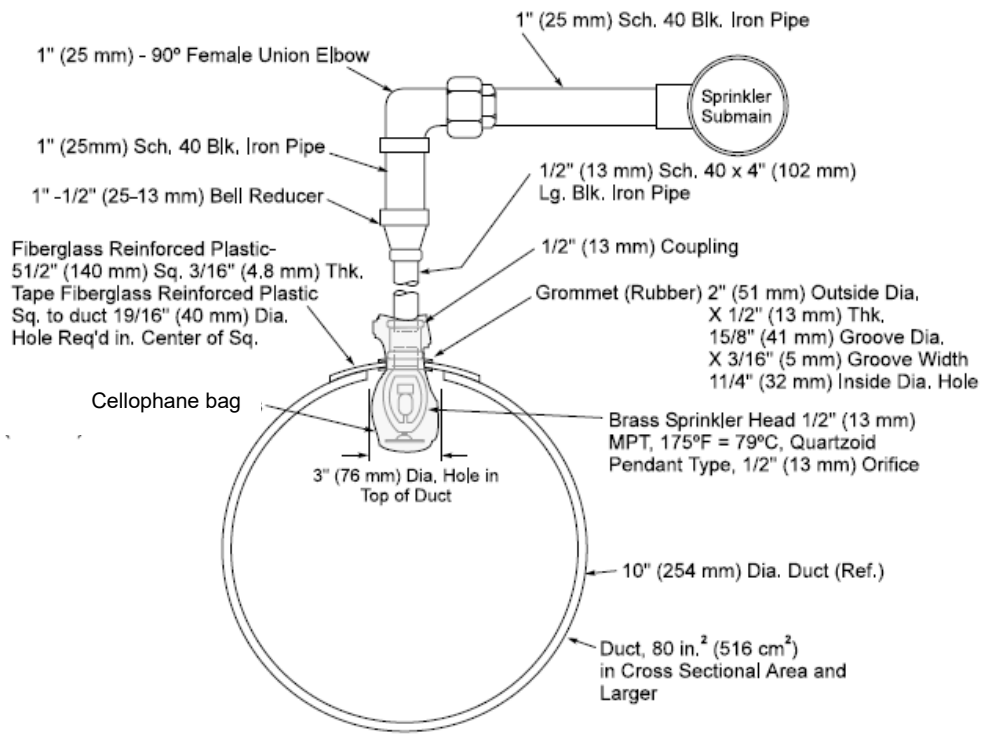

Fig. 1 - Typical sprinkler installation within a duct
(Factory Mutual) Posted and reprinted with permission of FM Global. ©2016-2017 Factory Mutual Insurance Company. All rights reserved.

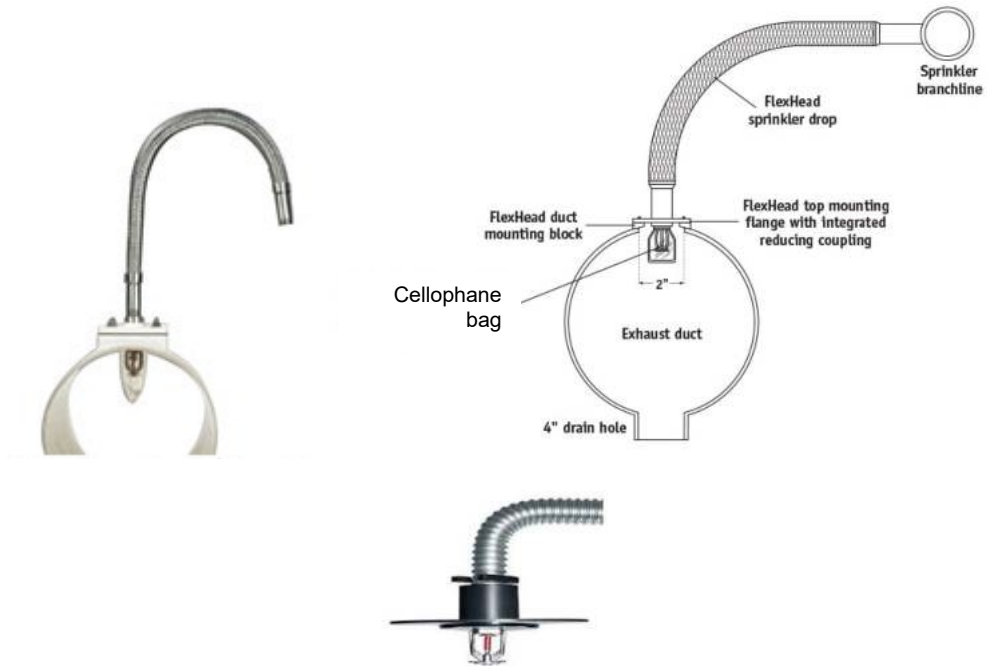

Fig. 2 - Examples of flexible sprinkler connections
Posted and reprinted with permission of FM Global. ©2016-2017 Factory Mutual Insurance Company. All rights reserved.

Notes:
Reference documents:
NFPA 13 - Standard for the Installation of Sprinkler Systems
Factory Mutual Data Sheet 7.78 - Industrial Exhaust Systems



21. IGNITABLE LIQUID STORAGE TANK

Where spacing between adjacent tanks or tanks and other facilities is inadequate, as per table 2 below (FM 7-88 Ignitable Liquid Storage Tanks), provide a deluge water spray (installed in accordance with DS 4-1N) on all exposed tanks at a rate of 0.3 gpm/ft² (12 mm/min) over the tank surfaces. Include a water supply duration of 2 hours and at least 500 gpm (1,900 L/min) for hose streams.

Table 2. Spacing for Ignitable Liquid Storage Tanks and Loading/Unloading Stations

Liquid, Arrangement	Liquid Flash Point ⁽¹⁾⁽²⁾	
	≤ 140°F (60°C)	> 140°F (60°C)
Stable liquids, tank to bldgs of non combustible or better construction (See Appendix A) or open process structures ⁽³⁾	1 D (min. 75 ft, 23 m)	0.5 D (min. 50 ft, 15 m)
Stable liquids, tank to buildings of combustible construction (See Appendix A)	2 D (min. 125 ft, 38 m)	1 D (min. 75 ft, 23 m)
Stable liquids in listed UL 2080 or 2085 containers	See Section 2.2.2.6	
Unstable liquids, tank to bldgs of any construction	2 D (min. 125 ft, 38 m)	1 D (min 75 ft, 23 m)
Stable liquids, tank to tank	0.5 D (min. 3 ft, 0.9 m)	0.5 D (min. 3 ft, 0.9 m)
Unstable liquids, tank to tank	1 D (min. 5 ft, 1.5 m)	1 D (min. 5 ft, 1.5 m)
Tank truck and railcar loading/unloading to tank, ⁽⁴⁾	75 ft (23 m)	50 (15 m)
Tanks (single or multiple) to LPG storage	Minimum 100 ft (30 m) or 1 D	

Notes

¹ Where tanks are equipped with internal heating systems and store liquids subject to boil over, froth over, or slop over, evaluate as if containing liquids with flash points ≤ 140°F (60°C), regardless of their flashpoint.

² D refers to the diameter of the largest flammable liquid tank.

³ Open process structure refers to areas of one or multiple levels used to manufacture chemicals. Intermediate tanks considered part of the process are excluded from this spacing requirement.

⁴ For separation between loading/unloading facilities and buildings, see DS 7-32, *Ignitable Liquid Operations*.

Source: FM Global Property Loss Prevention Data Sheet 7-88 (04/20) Used with permission. © 2020 Factory Mutual Insurance Company. All rights reserved.

Comments:

This should be investigated for all ignitable liquid storage tanks such as (but not limited) to: Mobile mining equipment fuel oil supply, Power Plant fuel oil tanks and Port Pitch tanks.



XII - ANNEX

1. ANNEX A: TECHNICAL REFERENCES

The following documents were consulted for this study:

- World Aluminium. The Global Aluminium Industry 40 years from 1972. Dr Carmine Nappi February 2013.
- The Aluminum Association. Rolling Aluminum From The Mine Through The Mill.pdf. 2007.
- NFPA 13 ed 2019 and previous “Standard for the installation of sprinkler systems”
- NFPA 25 ed 2020 “Standard for the Inspection, Testing, and Maintenance of Water-Based Fire Protection Systems”
- NFPA 30 Flammable and Combustible Liquids Code
- NFPA 214 “Standard on Water Cooling Towers”
- NFPA 850 “Recommended Practice for Fire Protection for Electric Generating Plants and High Voltage Direct Current Converter Stations”
- NFPA 855 ed 2020 “Installation of Stationary Energy Storage Systems”
- NFPA 2001 “Standard on Clean Agent Fire Extinguishing Systems”
- FM Global Data Sheets 1-4 “Fire Tests”
- FM Global Data Sheets 1-6 “Cooling towers”
- FM Global Data Sheets 1-57 “Plastic in Construction”
- FM Global Data Sheets 5-4 “Transformers”
- FM Global Data Sheets 5-19 “Switchgear and Circuit Breakers”
- FM Global Data Sheets 5-33 “Electrical Energy Storage System”
- FM Global Data Sheets 7-11 “Conveyor Belts”
- FM Global Data Sheets 7-32 “Flammable Liquid Operations”.
- FM Global Data Sheets 7-64 “Aluminum Industry”
- FM Global Data Sheets 7-64R “Aluminum Industry Processes”
- FM Global Data Sheets 7-78 “Industrial Exhaust Systems”
- FM Global Data Sheets 7-79 “Fire Protection for Gas Turbines and Electric Generators”, with some remarks
- FM Global Data Sheets 7-98 “Hydraulic Fluids”
- FM Global Data Sheets 7-99 “Heat Transfer by Organic and Synthetic Fluids”
- FM Global Data Sheets 7-101 “Fire Protection for Steam Turbines and Electric Generators”

This list is not exhaustive.



2. ANNEX B: EXPLANATORY MATERIAL

2.1. Alumina Raw Material - Nepheline

Bauxites are the most common raw materials for making alumina but they are not the only ones. Alumina can also be made from Nepheline. Nepheline occurs in the form of apatite-nepheline rock (apatite is a calcium phosphorous oxide). The production process for making alumina from nepheline also by-produces soda, potash (a material used in construction, in the production of some chemicals, in the food industry etc.), and the rare metal Gallium. The production waste, white mud, can be used to make high-quality cement. It takes 4 tons of nepheline and 7.5 tons of limestone to make 1 ton of alumina.

There is another far less common method for making alumina called Sintering. The idea is to make solid materials from powders at high temperatures. Bauxites are sintered with soda and lime. The latter two elements bind the silica into insoluble silicates that can then be easily separated from alumina. The sintering process is more energy-intensive than the Bayer process, but it can be used to make alumina from bauxites with a high content of toxic silica admixtures.

2.2. Alumina Refining – Products

Large aluminum hydrate particles can be filtered out of the solution with relative ease. They are then washed with water, dried and calcined: i.e. heated up to remove water. The output of this process is Alumina. There are different alumina products:

- **Alumina Hydrate (coarse)**

Aluminum hydroxide or alumina trihydrate (ATH) is the hydrated oxide of aluminum. Alumina hydrate is separated from bauxite ore using the Bayer process, with average particle sizes ranging from 80-100 microns. The block crystals of alumina hydrate have good chemical reactivity. Alumina hydrate can react with a base as well as an acid and is used in many applications as a raw material.

- **Alumina Hydrate (fine)**

After drying, alumina hydrate is ground using mechanical mills and ceramic-lined ball mills to obtain finer particle sizes.

- **Calcined Alumina (coarse)**

Aluminum hydroxide, or alumina trihydrate obtained in the Bayer process, is calcined at temperatures above 1200°C and up to 1600°C to manufacture special grade alumina. During calcination, alumina hydrate crystals lose bound moisture and re-crystallize to form alumina crystals. The particle size of alumina is still around 85-100 microns. Special alumina predominantly contains “α-phase ultrafine Al₂O₃” (a high-performance and high-hardness material with high dimensional stability. It is widely used in a variety of plastics, rubber, ceramics and refractory products for reinforcement toughening, in particular in order to improve the ceramic density, finish, thermal fatigue resistance, fracture toughness, creep resistance and wear resistance.) The degree of calcination is a measure of the hardness of alumina – soft to hard. Coarse alumina is classified, based on the soda (Na₂O) content:

- Low soda alumina - Na₂O <0.1%
- Medium soda alumina - 0.1% < Na₂O <0.2%
- Normal soda alumina - 0.20% < Na₂O < 0.45%

- **Fine Alumina**

Calcined alumina is ground in fluid energy mills or ceramic-lined ball mills to meet the desired particle size required by the customers. Low soda, medium soda and normal soda-types are also available in fine alumina.



- **Reactive Alumina**

This alumina predominantly contains very finely-sized particles. The special characteristics of reactive alumina are a high thermal reactivity and low water absorption. Upon sintering, reactive alumina will give a density close to the true density of alumina.

2.3. Alumina Refining – Use of Red Mud

Many experts do not regard red mud as a waste because it can be used as a raw material. For example, Scandium can be made from it and then used in aluminum scandium alloys. Scandium makes aluminum alloys extra strong and such alloys can then be used in motor vehicles, rockets, sports equipment and in the production of electric wires.

Red mud can also be used in the production of cast iron, concrete and rare earth metals.

Other publications in this series:

- **RISK CONTROL PRACTICE: CONSTRUCTION MATERIAL**
Wall Assembly Classification Handbook
- **RISK CONTROL PRACTICE: EXPOSURE**
Falling Aircraft Handbook
- **RISK CONTROL PRACTICE: SPECIAL HAZARDS**
 - Embankment Dams Handbook
 - Tailings & Tailings Management Facilities Handbook
- **RISK CONTROL PRACTICE: OCCUPANCY**
 - Renewable Energy Handbook
 - Steel Handbook
- **RISK CONTROL PRACTICE: LOST ESTIMATE**
 - Maximum Possible Loss (MPL) Handbook

To learn more about SCOR's strategy, goals, commitments and markets, visit our website.

www.scor.com

Follow us on social media



SCOR
The Art & Science of Risk

