

APRIL 2021

RISK CONTROL PRACTICE: OCCUPANCY

Renewable Energy Handbook
Engineering & Property

Didier L. SCHÜTZ

Risk Control Practice Leader
SCOR

SCOR
The Art & Science of Risk



This Handbook | Guidance Note has been prepared to identify and flag issues a prudent Underwriter and Risk Engineer ought to consider and evaluate relating to industries involving Renewable Energy - risk selection, determination and calculation of loss estimates - when determining whether to accept a risk and, if so, on what terms.

Although this Handbook | Guidance is detailed and deals with a number of hazards, it is not intended to be a comprehensive analysis of every peril and potential scenario an underwriter may be requested to provide cover for. Any estimation or projection of an MPL and final loss amount must be based on reliable, accurate and current values, applicable scenarios, and consideration of the relevant perils. SCOR accepts no responsibility or liability for any use of this handbook by any party in order to underwrite any particular risk or to determine a Loss Estimate or final loss amount – it is the responsibility of the relevant underwriter and (re)insurer to independently determine whether to accept, or not, any particular risk and the contract terms and price to be required.

© Copyright SCOR SE. All rights reserved. Permission granted to reproduce for personal and educational use only.

© Shutterstock: Image(s) used under license from Shutterstock.com

First edition in 2017

CONTENT

SCOPE	1
I - RENEWABLE ENERGY: ATTEMPT AT DEFINITION & CLASSIFICATION	1
1. RENEWABLE ENERGY: ATTEMPT AT DEFINITION	1
2. RENEWABLE ENERGY: ATTEMPT AT CLASSIFICATION	1
2.1. Experimental technology (Research & Development).....	1
2.2. Advanced Technology (Continuous improvement)	1
2.3. Mature Technology (Proven).....	1
II - WIND ENERGY (WE)	2
1. WE - RISK CONTROL TOPICS.....	2
2. WE - LOSS EXPERIENCES	12
3. WE - LOSS ESTIMATES	18
4. WE - UW CONSIDERATIONS.....	22
4.1. Warning.....	22
4.2. UW Risk Assessment – Engineering – Onshore Wind Farms	22
4.3. UW Risk Assessment – Engineering - Offshore Wind Farms	23
4.4. UW Risk Assessment – Property – Onshore Wind Farms.....	24
4.5. UW Risk Assessment – Property – Offshore Wind Farms.....	25
5. WE - CLAIMS CONSIDERATIONS.....	27
5.1. Onshore	27
5.2. Offshore	27
III – PHOTOVOLTAIC SOLAR ENERGY (PSE)	28
1. PSE - RISK CONTROL TOPICS.....	28
2. PSE - LOSS EXPERIENCES.....	42
3. PSE – LOSS ESTIMATES	47
4. PSE - UW CONSIDERATIONS	48
4.1. Warning.....	48
4.2. UW Risk Assessment – Engineering – Photovoltaic Solar Energy	48
IV - THERMAL SOLAR ENERGY (TSE)	49
1. TSE - RISK CONTROL TOPICS.....	49
2. TSE - LOSS EXPERIENCES.....	53
3. TSE - LOSS ESTIMATES	54

4.1. Warning.....	55
4.2. UW Risk Assessment – Engineering – Thermal Solar Energy.....	56
4.3. UW Risk Assessment – Property – Thermal Solar Energy.....	56
V - MATURE TECHNOLOGY (PROVEN).....	58
1. GEOTHERMAL ENERGY (GE)	58
2. HYDRAULIC ENERGY (HYDROPOWER).....	60
VI - HYBRID RENEWABLE ENERGY (HRE)	61
1. HRE - PHOTOVOLTAIC THERMAL HYBRID SOLAR COLLECTOR	61
2. HRE - HYDRO & WIND	61
3. HRE - PHOTOVOLTAIC (PV & WIND)	62
VII - OTHER ADVANCED TECHNOLOGIES.....	62
1. BIOMASS	62
2. BIOFUEL	63
3. FUEL CELLS	65
4. MARINE (STREAM & TIDE)	66
1. NUCLEAR FUSION	67
IX - (ELECTRICAL) ENERGY STORAGE SYSTEMS (ESS).....	69
1. STORAGE OF ELECTRICAL ENERGY.....	69
2. ESS – RISK CONTROL TOPICS.....	69
X - SMART GRIDS & RENEWABLES	71
XI - SUPPORT FOR LOSS PREVENTION RECOMMENDATIONS	73
1. SUBSTATIONS / MCC ROOMS / SERVER ROOMS / ELECTRIC ROOMS.....	73
2. BATTERY ROOMS (ESS)	75
3. TRANSFORMERS.....	76
4. STEAM TURBINE GENERATORS.....	85
5. COOLING TOWERS (FOR STEAM TURBINES).....	92
6. HEAT TRANSFER FLUID (HTF).....	95
1. NATIONAL FIRE PROTECTION ASSOCIATION (NFPA) STANDARDS.....	96
2. FACTORY MUTUAL GLOBAL DATA SHEETS (FM GLOBAL DATA SHEET).....	96
3. KEMPER TECHNICAL PROCEDURES MANUAL (TPM).....	97
4. OTHER.....	97

SCOPE

This Handbook was prepared by members of several Property & Casualty business teams and disciplines within SCOR, including those responsible for evaluating and controlling risk and underwriting teams. Many thanks to them. Their names are mentioned in this document with their permission. Should you wish to discuss any of the contents of this Handbook or the issues it raises, please contact:

- Miguel Angel Prado – mpradocabrero@scor.com
- Didier L. Schutz – dschutz@scor.com

The previous version V1 was released in 2017 focusing exclusively on large scale projects for the supply of merchant renewable energy power. This new version V2 also focuses on decentralized solar power applications (i.e. local producers or producers building-mounted) introducing aggravating factors on industrial, commercial and residential facilities. Moreover, (Electrical) Energy Storage Systems (ESS) are also discussed in this handbook.

This Handbook is intended to provide underwriters with a practical and detailed framework for assessing and underwriting renewable energy risks. It is the product of more than fifteen years of SCOR's underwriting of renewable energy risks in many different locations including Northern and Southern Europe, Africa and North and South America.

Standard recommendations based on recognized international standards and good practices are proposed. Moreover, very good NFPA (National Fire Protection Association) and Factory Mutual Data Sheets (FM Global Data Sheets) on these subjects exist. As there is no need to reinvent the wheel, readers are referred to those references when relevant.

- NFPA free viewing at <http://www.nfpa.org/>
- FM Global Data Sheets free viewing and download when registered at <http://www.fmglobal.com/>

Note that these materials are periodically revised and updated. Please, monitor the above websites for updates and/or revisions.

However, this Handbook is not a definitive guide and it is not intended to cover all aspects of risk control and the underwriting of renewable energy activities, operations and risks, nor is it intended to be a substitute for an engineer's, risk manager's and/or underwriter's etc. own assessment of a renewable energy risk and exposure.

It should be noted that renewable energy technologies are undergoing rapid and continuous development, requiring engineers, risk managers and underwriters to remain alert to the new risks and hazards that are emerging and that may render topics and issues discussed in this Handbook redundant and/or out of date.

© Copyright SCOR SE. All rights reserved. Permission granted to reproduce for personal and educational use only.

I - RENEWABLE ENERGY: ATTEMPT AT DEFINITION & CLASSIFICATION

1. RENEWABLE ENERGY: ATTEMPT AT DEFINITION

Unfortunately, there is no standard, unique or accurate definition of renewable energy. The following main definitions can be found:

- In ISO 13602-1:2002, a renewable resource is defined as "a natural resource for which the ratio of the creation of the natural resource to the output of that resource from nature to the technosphere is equal to or greater than one".
- Renewable energy is derived from natural processes that are replenished constantly. In its various forms, it derives directly from the sun or from heat generated deep within the earth. Included in the definition is electricity and heat generated from sunlight, wind, oceans, hydropower, biomass, geothermal resources, and biofuels and hydrogen derived from renewable resources.

2. RENEWABLE ENERGY: ATTEMPT AT CLASSIFICATION

In fact, the renewable energy industry is still on a learning curve. From a technological standpoint, renewable energies can be arbitrarily divided into 3 classes as follows:

2.1. Experimental technology (Research & Development)

The following renewable energy risks involve technologies undergoing research and development and the facilities installed are basically lab testing facilities, pilots, and prototypes such as:

- Nuclear Fusion

More details are given in chapter VIII.

2.2. Advanced Technology (Continuous improvement)

The following renewable energy risks involve advanced technologies:

- involving relatively new systems that are continuously being developed in order to upgrade reliability and performance such as:
 - Wind Energy
 - Photovoltaic Solar Energy
 - Thermal Solar Energy

More details are given in chapters II, IV and V.

- involving relatively well-known / old systems whose performances and reliability are still not adequate for optimum industrial / commercial purposes and are being improved:
 - Biomass
 - Biofuel
 - Fuel Cell
 - Marine (Stream & Tide)

More details are given in chapter VI

2.3. Mature Technology (Proven)

The following renewable energy risks involve well known technologies and several installed facilities have been operating for years:

- Geothermal Energy
- Hydraulic Energy

An overview is given in chapter 5.

II - WIND ENERGY (WE)

This section is limited to "large scale wind energy production systems" excluding "residential / local use".

1. WE - RISK CONTROL TOPICS

Occupancy

Wind power is the conversion of wind energy into a useful form of energy, such as using wind turbines to produce electrical power, windmills for mechanical power, windpumps for water pumping or drainage, or sails to propel ships. The current section is exclusively focused on wind turbines to produce electrical power:

Large wind farms consist of hundreds of individual Wind Turbines (WTs) which are connected to the electric power transmission network.

There are basically two main types of Wind Turbines as follows:

- Horizontal-axis wind turbines (HAWTs)
- Vertical-axis wind turbines (VAWTs)

Horizontal-axis wind turbines (HAWTs) are a type of wind turbine where the main rotor shaft is set horizontally and the main components are located within a nacelle, which sits on top of a tower as shown below:

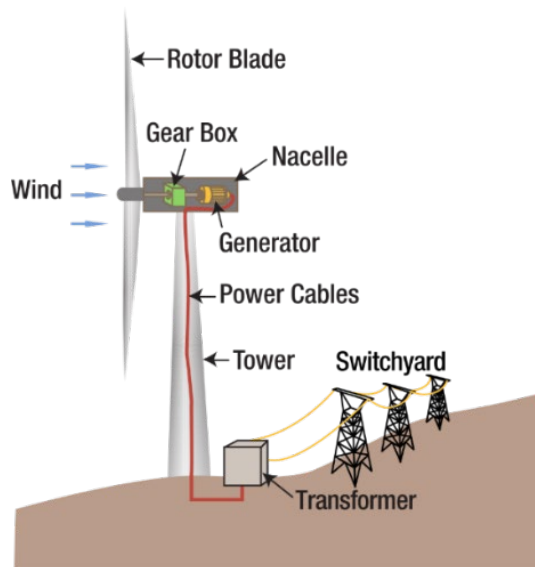

Source Google image labeled for reuse

Vertical-axis wind turbines (VAWTs) are a type of wind turbine where the main rotor shaft is set vertically, and the main components are located at the base of the turbine. Different designs were developed as shown below:



Source: Google image labeled for reuse

VAWTs offer a number of advantages over traditional horizontal-axis wind turbines (HAWTs) as follows:

- VAWTs do not need to be pointed into the wind which removes the need for wind-sensing and orientation mechanisms.
- They can be packed closer together in wind farms, allowing more in a given space.
- They are quiet, omni-directional, and they produce lower forces on the support structure.
- They do not require as much wind to generate power, thus allowing them to be closer to the ground where windspeed is lower.
- By being closer to the ground VAWTs are easily maintained and can be installed on chimneys and similar tall structures.
- VAWTs thrive in gusty winds.

Research at Caltech has also shown that carefully designing wind farms using VAWTs can result in power output ten times as great as a HAWT wind farm the same size. VAWTs are much quieter than HAWTs.

Disadvantages of vertical axis wind turbines (VAWTs) include:

- VAWTs were used to exhibit dynamic stability problems before modern engineering methods and installation procedures were established.
- The blades of a VAWT were fatigue prone due to the wide variation in applied forces during each rotation. This has been overcome by the use of modern composite materials. The vertically oriented blades used in early models twisted and bent during each turn, causing them to crack. Over time the blades broke apart, sometimes leading to catastrophic failure.

Because of these past problems, VAWTs have proven less reliable than HAWTs. Applications of VAWTs were therefore limited to individual use (home or office) and were developed in the early 2000s by the US Company, Mariah Power. VAWTs are no longer the wind turbine of predilection for manufacturers but, if constructed, the use of new materials overcomes the problems of the past.

Some research states that the economics of offshore wind power are different from land-based turbines due to installation and operational challenges. VAWTs offer three big advantages that could reduce the cost of wind energy: a lower turbine center of gravity, reduced machine complexity and better scalability to very large sizes. A lower center of gravity means improved stability afloat and lower gravitational fatigue loads. Additionally, the drivetrain on a VAWT is at (or near) the surface, potentially making maintenance easier and less time-consuming. Fewer parts, lower fatigue loads and simpler maintenance all lead to reduced maintenance costs.

As from 2001 the installed capacity of wind power worldwide has increased (see figures below).

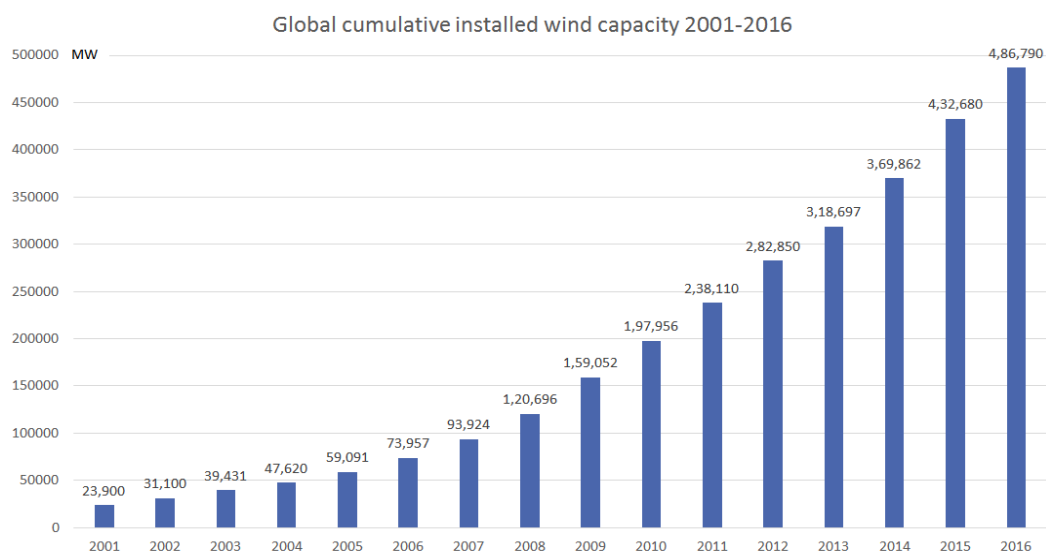

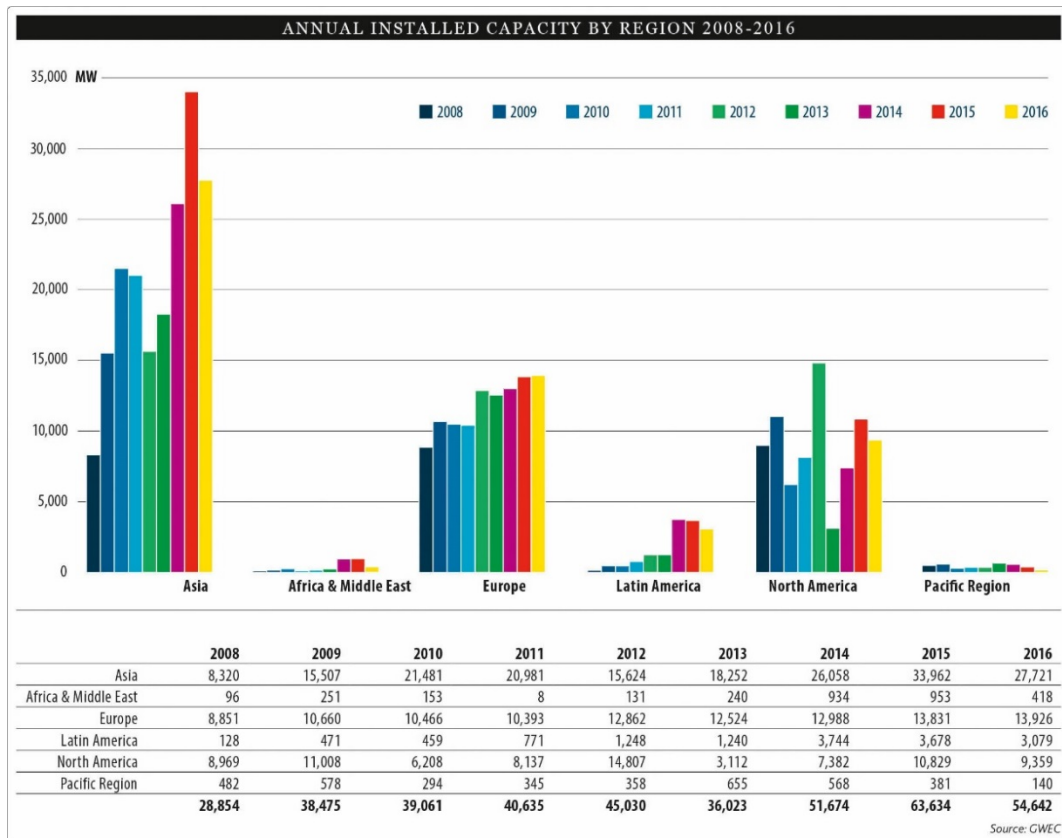

Source: Google image labeled for reuse

China is by far the largest installer of wind power capacity in the world, more than doubling the second-ranked United States.

- China 2019 = 237GW (36% of WW) vs. 2013 = 92GW (28.7% of WW)
- USA 2019 = 105GW (16% of WW) vs. 2013 = 61GW (19.2 % of WW)
- WW (Worldwide) 2018 = 650GW (China & USA nearly up to 52 %) vs. 2013 = 318GW (China & USA nearly up to 50 %).

Many of the largest operational onshore wind farms (basically HAWT types) are located in the United States and China.

In China:

- 2016: the Gansu Wind Farm in China had a capacity of over 5,000 MW of power with a target of 20,000 MW by 2020. The construction began in 2009.

In USA:

- 2016: The Alta Wind Energy Center in California, United States was the largest onshore wind farm outside of China, with a capacity of 1,020MW. The construction began in 2011.
- 2020: The Alta Wind Energy Centre is the biggest wind farm in the US. With a combined installed capacity of about 1,550MW, the power generated by the wind farm is sold to Southern California Edison under a 25-year power purchase agreement (PPA).

As a general rule, economic wind generators require a windspeed of 16 km/h (10 mph) or more. An ideal location would have a near constant flow of non-turbulent wind throughout the year, with a minimum likelihood of sudden powerful bursts of wind. An important factor of turbine siting is also access to local demand or transmission capacity.

In fact, the world is continuously searching for new efficient wind energy turbines. Each and every time, innovation translates into **bigger and more powerful units**.

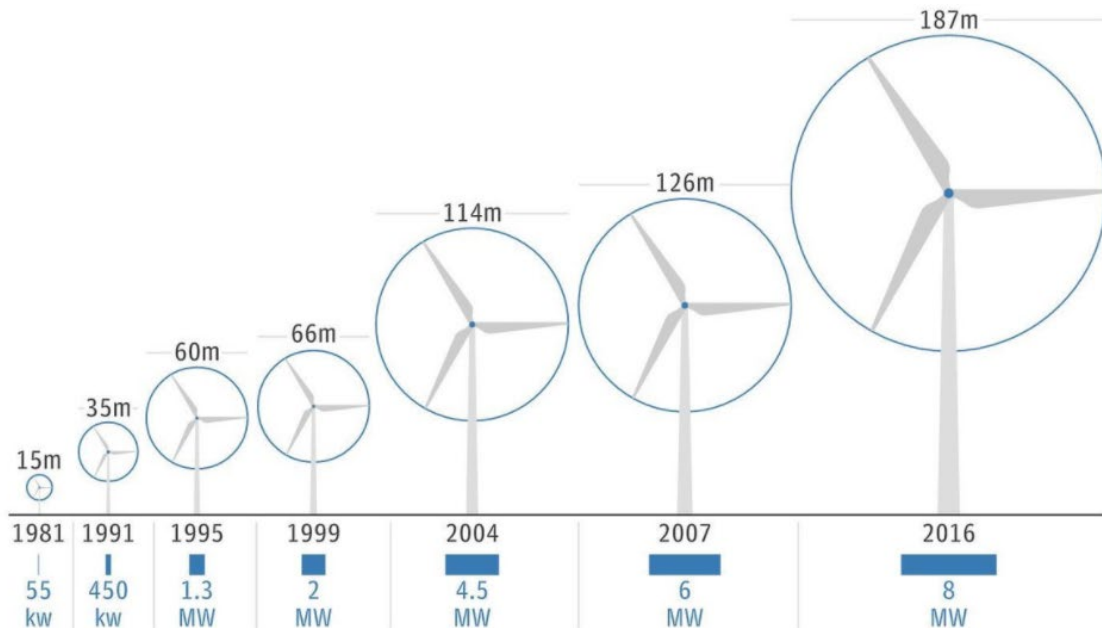

Examples:

- Vestas V164: with a rated capacity of 9.5 MW, this is the world's largest-capacity wind turbine since its introduction in 2014.
- Siemens Gamesa: the world’s largest 14MW offshore wind turbine, the largest capacity wind turbine in the world in 2020.
- SUMR50 project: Segmented Ultralight Morphing Rotors. US based researchers are developing a 50MW offshore wind turbine concept that would be the largest currently planned.

So far, the aerodynamics of a maximum tip speed of 200 m/sec (720 Km/h) is being considered. When we apply this to the 120 m diameter, we already face a maximum of almost 2 rotations per second or 113 revolutions / minute. This means that **rotation speed and propeller pitch are vital to manage the maximum advantage of wind** i.e., to balance the aerodynamic load and the electrical output.

Wind turbines need a minimum wind speed (at which the WT produces the rated power) to start to produce electrical power up to a maximum wind speed at which the wind turbine should either be maintained (using the brake) or stopped in a safe position.

Wind turbines can either be onshore or offshore (with the WT support tower either on a floating base or on a foundation on the sea bottom):

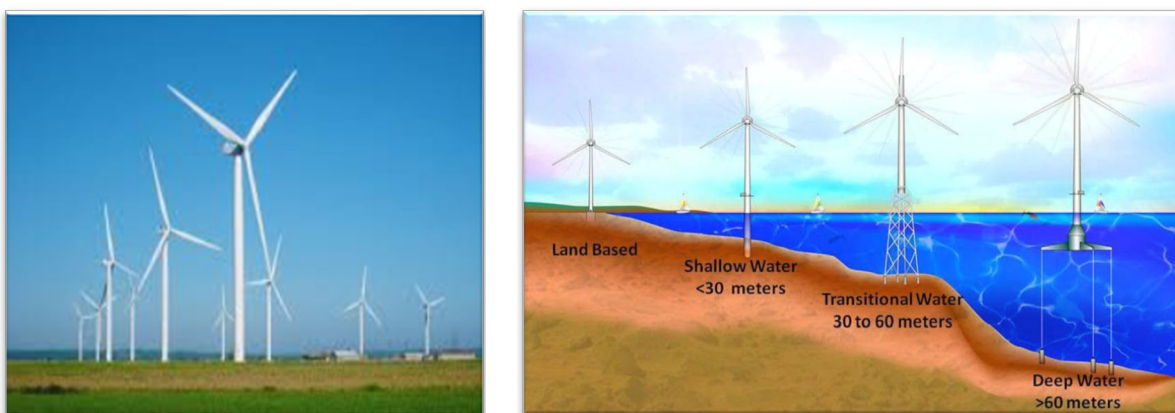

Source: Google image labeled for reuse

The potential of wind energy around the world is immense and wind power can often be accessed from remote places, as seen in the rise of offshore wind energy.

Client Guidance Note – Risk Control Practice

Individual turbines are interconnected with a medium voltage power collection system and communications network. At a substation, this medium-voltage electrical current is increased in voltage with a transformer for connection to the high voltage transmission systems. Construction of a land-based wind farm requires the installation of a collector system and substation, and possibly access roads to each turbine site.

Most components of a horizontal-axis wind turbine (HAWT) are contained within the nacelle, which sits on top of the tower as follows (see diagram below):

- Blades are attached to the hub.
- The drive train is the mechanism that transfers the energy from the rotor shaft to the generator. There are two drive train design concepts:
 - Integrated: shaft, gearbox and generator in one unit – compact, but makes replacing difficult.
 - Module: gearbox, shaft and generator separate.
- Gearbox: is required if the generator is asynchronous (as it is in most cases due to the relatively low cost compared to a synchronous generator).
- Generator: either synchronous or asynchronous, converting mechanical energy into electric energy (current).
- Inverters: inverters transform the generator's output frequency (Direct Current – DC) to the grid-required frequency (Alternative Current- AC). If the WT has a fixed rotor speed (with no pitch), inverters are not required. Most WTs have a variable rotor speed (as they operate at a fixed tip speed ratio). The inverters can control both the frequency of current and the speed of the asynchronous generator. In the configuration with a synchronous generator, the grid connection is done completely via inverters. Inverters can be located inside the nacelle or inside the base of the support tower.

Main Components of a Wind Turbine (WT) - including gearbox (asynchronous generator) also called “conventional wind turbine”:

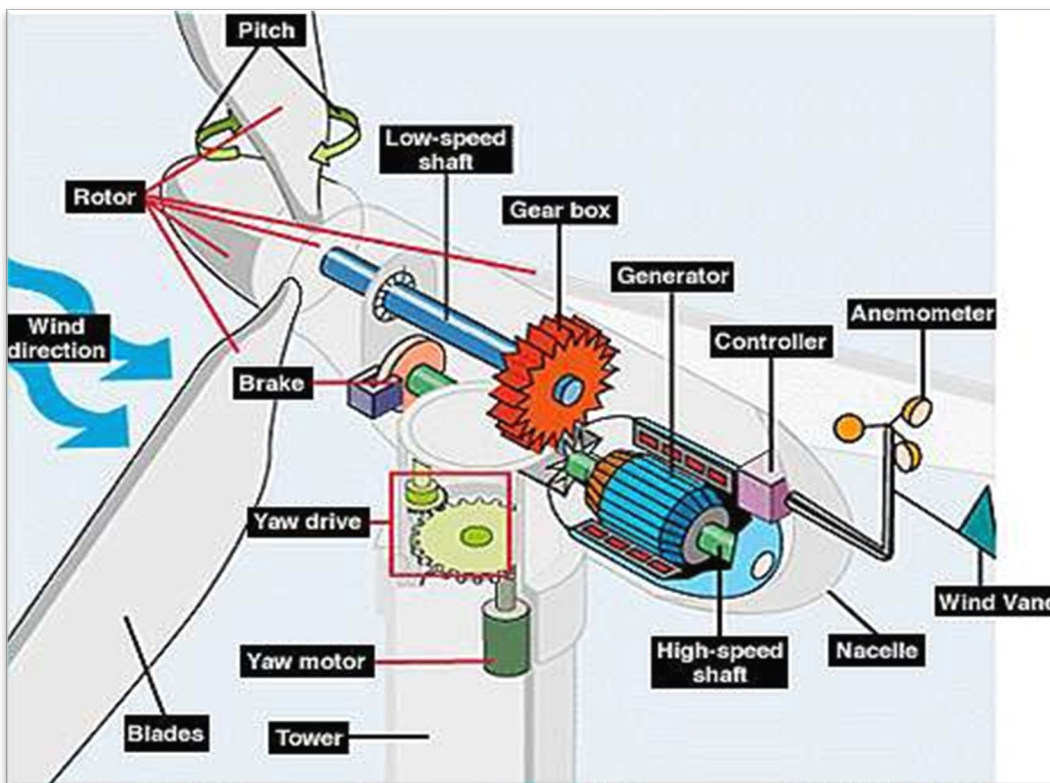

Source: Google image labeled for reuse

In conventional wind turbines, the blades spin a shaft that is connected through a gearbox to the generator. The gearbox converts the turning speed of the blades – 15 to 20 rotations per minute for a large, one-megawatt turbine – into the faster 1,800 rotations per minute that the generator needs to

generate electricity. Wind turbines are very different from any other gearbox application (going from a very low speed to a high speed whereas, typically, the opposite applies).

The multiple wheels and bearings in a wind turbine gearbox suffer tremendous stress because of wind turbulence, and a small defect in any one component can bring the turbine to a halt. This makes the gearbox (see Machinery Breakdown MPL operational scenario: trigger for serial losses) the most high-maintenance part of a turbine (maintenance / repair costs up to 10 times more expensive for offshore). Gearboxes in offshore turbines, which face higher wind speeds, are even more vulnerable than those in onshore turbines. Butterfield is leading a gearbox-reliability study with turbine makers to identify design weaknesses that could be avoided.

Instead of gearboxes, direct-drive generator technology 3.5-megawatt turbines are being developed. The objective is to make the turbines more reliable, by cutting downtime and repair costs – an especially important consideration for turbines offshore, where it’s more expensive to send technicians for maintenance. Gearless WT’s have been tested on the Norwegian coast since 2003.

Main Components of a Wind Turbine (WT) - gearless box also called “direct-drive generator wind turbines”:

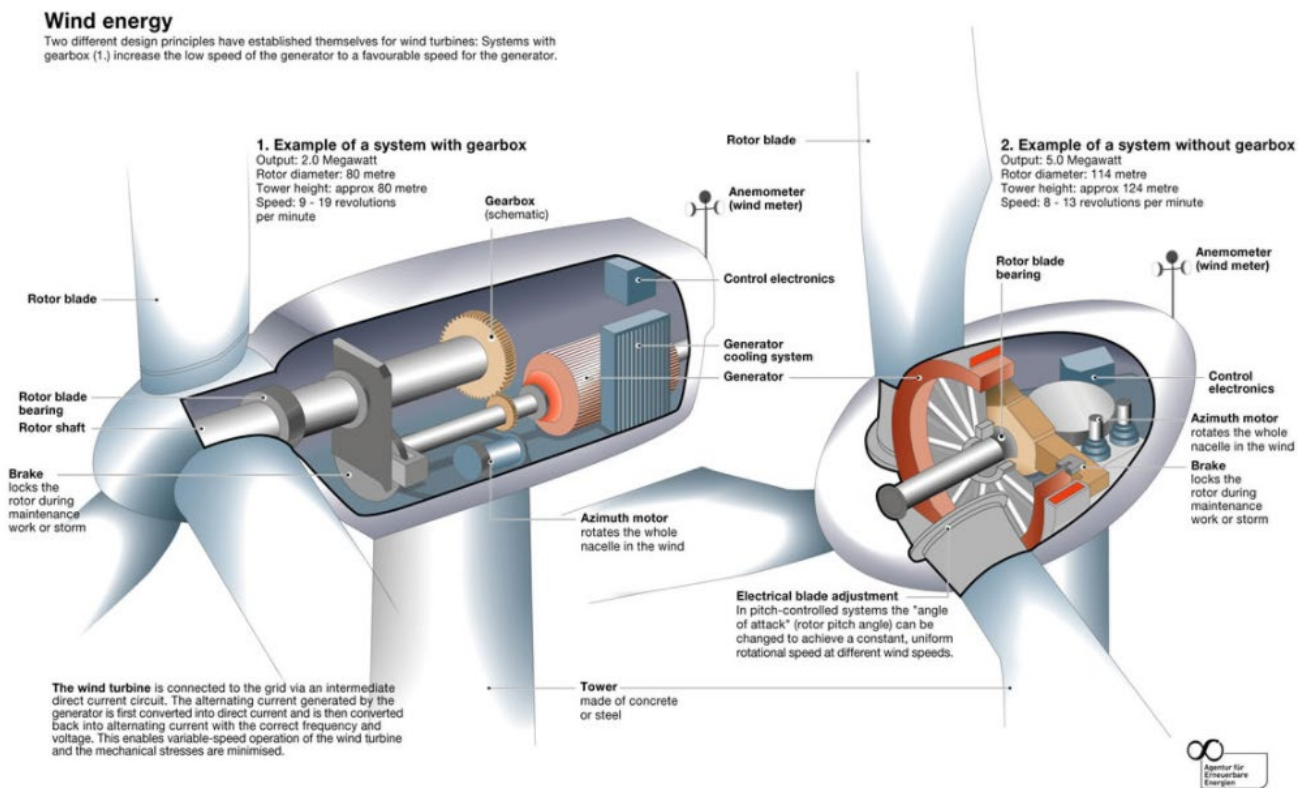

Source: Google image labeled for reuse

Eliminating the gearbox from the wind turbine removes the technically most complicated part of the machine, inherently improving reliability.

Gearless wind turbine design gets rid of the gearbox completely. Instead, the rotor shaft is attached directly to the generator which spins at the same speed as the blades. In a turbine generator, magnets spin around a coil to produce current – the faster the magnets spin, the more current is induced in the coil. To make up for a direct drive generator’s slower spinning rate, the radius of rotation is increased, effectively increasing the speed with which the magnets move around the coil. As a result, gearless wind turbines are often heavier than gear-based wind turbines.

Direct-drive generators currently cost more than geared systems and are 15 to 20 percent heavier. The WT industry is highly competitive, and the market is requesting higher output per turbine. In order to be more competitive, the performance of the Wind Turbine is increasing (6MW turbines are already in production). Increasing the performance, by reducing the weight of the nacelle, can be reached by increasing the length of the blades.

New material (carbon, stronger and lighter) can already reach a wingspan of 60 to 70 meters.

However offshore machines are so expensive in terms of maintenance that direct-drive generators could be a suitable alternative once cost can be reduced.

However, because the high torque requirements are demanding, direct-drive wind turbines up to 7-10 MW require significantly larger and heavier generators. In this case, a single or two-stage gearbox is the better choice, as it is a much smaller, lighter solution and it provides the same advantages as the direct-drive generator.

To produce electricity at a low rotary speed, the manufacturers had to design a specific generator.

There are two categories of wind turbine generators: permanent magnet generators (PMGs) and electrically excited synchronous generators (EESGs):

- EESGs do not have permanent magnets made from rare materials such as neodymium, the extraction of which can cause environmental damage.
- On the other hand, PMGs have several advantages such as high efficiency with the elimination of field loss (unlike today's electromagnetic generators, permanent magnets don't need power). In addition to being small and lightweight compared to the EESGs, PMGs are usually used in small-scale wind turbines but can also be used in large MW applications.

Since traditional generators have a cylindrical shape, the permanent magnet synchronous generators provide a better fit for direct-drive due to their "doughnut" configuration. However, to achieve the required high torques, the effective permanent magnet rotary motion must be increased. Ultimately, this means that a significantly larger diameter generator must be provided.

In 2016, experts from the Technical University of Denmark estimated that a geared generator with permanent magnets may use 25 kg/MW of the rare earth element neodymium, while a gearless one may use 250 kg/MW. In December 2011, the US Department of Energy published a report stating a critical shortage of rare earth elements such as neodymium used in large quantities for permanent magnets in gearless wind turbines. China produces more than 95% of rare earth elements, while Hitachi holds more than 600 patents covering neodymium magnets. Direct-drive turbines require 600 kg of PM material per megawatt which translates to several hundred kilograms of rare earth content per megawatt, as the neodymium content is estimated to be 31% of magnet weight. Hybrid drivetrains (intermediate between direct-drive and traditionally geared) use significantly less rare earth materials. While PM wind turbines only account for about 5% of the market outside of China, their market share inside of China is estimated at 25% or higher. Demand for neodymium in wind turbines is estimated to be 1/5 of that in electric vehicles.

As a result of the above (Gearbox vs. Direct-Drive) the most important factors for selecting proper wind turbines are cost and technology reliability. The developments in direct-drive magnets and generator arrangements resulted in a more affordable, lighter direct-drive model. The price of the permanent magnets used in direct-drive turbines has also dropped significantly, increasing their popularity. On the other hand, there are thousands of gearbox turbines currently available and in use in the market, which means that this type of turbine cannot suddenly be replaced with direct drive.

Exposures:

Natural perils for onshore WT:

- Flood Zone
- Earthquake
- Tsunami (for WTs and substations located in a coastal area)
- Wind (especially areas exposed to tropical and winter storms)
- Lightning (carbon wings cause lightning too, resulting in a higher range of lightning flash)
- Wind with ice accretion (due to atmospheric icing, freezing rain, sea spray, snow, others) can lead to an unbalanced rotation of the blades and extreme vibrations.
- Hail can damage both blades and turbine sensors.

Other perils for onshore WT:

- Fire (including arson)



- Theft: copper cabling theft can affect several units.
- Wildfire/Bushfire



- Third party liability - e.g., an ice block detached from the WT's blade hitting a third party (including other wind farms)
- Contingent Business Interruption and potential accumulation when various clients of WT farm(s) are affected following an interruption of operations at WT farm(s).

Natural Perils for offshore WT:

- Structural fatigue of the towers due to exposure to high wind (this can reduce the life span of the tower)
- Hydrodynamic loads, tsunami loads, and marine vessel impact (Loss scenario for offshore wind parks) can lead to mechanical stress and structural damages.
- Impact on Transformer - independent platform with high value for each offshore wind park (a trigger for BI)
- Wildlife impact - e.g., birds flying into rotor blades can lead to blade damages and a subsequent imbalance in rotation if parts are removed.

Special hazards:

Structural:

- Structural load on wind turbine foundations

Machinery breakdown:

- Gear box below or rotor shaft failure in the case of a gearless WT
- Vibration and disintegration due to unbalanced rotation or over-speed
- Rotating equipment (over-speed, vibration, disintegration)
- Control function failure

Corrosion:

- This causes degradation and loss

Fire (internal/external)

- Combustible construction material
 - Rotor: polyester or composite (Fiber Reinforced Epoxy / Plastic / Carbon)
 - Nacelle: metal frame, glass-fiber shell
 - Tower: steel
- Control and lubricating oil piping leakage, ignition and fire
- Cables with combustible insulation
- Gearbox problems can lead to fires due to overheating and are not, therefore, limited to machinery breakdown losses only
- Oil-filled equipment inside the nacelle (gears, bearings, hydraulic group) or the support tower (transformer)
- Man-made ignition sources (especially during maintenance works)
- Fire inside the collector or substation of the WT farm (electric fire involving transformer, generator, control panel)

Aggravating factors:

- Limited & difficult access
- Normally non-occupied area (vacant / rural area)

Loss Prevention Recommendations:

Natural Perils for onshore WT:

- Flood: locate wind farm outside flood zone
- EQ rated design should be considered in accordance with location exposure
- Tsunami: locate wind farm outside tsunami zone
- Wind studies (to assess effect on structure) should be carried out prior to construction and during operations (effect of strong wind and impact on life span)
- Lightning: provide protection as per FM Global Data Sheet 13-10 Wind Turbines, such as (but not limited to):
 - Install lightning protection or surge counters to detect a lightning strike
 - Provide direct-strike lightning protection for the wind turbine blades, nacelle and tower
 - Provide surge arrestors for the generator and transformer, transient voltage surge suppression for the power electronics, control and communication systems, Faraday cage-type protection for equipment located in the nacelle and a Faraday shield for communication and control cables running up the tower into the nacelle

Client Guidance Note – Risk Control Practice

- Provide lighting protection for the gearbox, drive shaft bearings, yaw bearings and generator bearings
- Anti-ice accretion coating or vibration monitoring system and trip system required.
- Hail: Blades should be adequately designed to sustain hail impact in a given area and turbine sensors should be provided with adequate protection.
- Wildfire/bush fire (i.e., onshore WT): Provide adequate minimum clearance against bush fire / wildfire as per FM Global Data Sheet 9-19.
- Wildlife impact (birds): Ensure that blades are designed to withstand a bird strike without incurring damages.

Structural load for onshore WT:

- Ensure adequate structural load studies have been carried out prior to construction and considered for design. This should include fatigue resistance as follows:
 - Governing load for onshore WT:
 - The load governing the turbine or tower design should be clearly established (wind load vs. seismic load for seismically active area)
 - The foundation design loads should:
 - Be based on extreme operation and fatigue load
 - Consider all Geologic/Geotechnical Hazards (Earthquake ground shaking, Faulting/Surface & Rupture/Tectonic deformation, Liquefaction, Seismic Seiche/Storm surge, Flash Flooding/Debris Flows, Landslides/Rock Fall, Collapse Potential, Slope stability)
 - Consider possible ground improvement to mitigate soft ground conditions with liquefaction potential.

Structural load for offshore WT:

- Ensure hydrodynamic loads are correct.
- Ensure Tsunami loads are properly designed for a given area
- Ensure that adequate marine vessel impact protections are provided.

Machinery breakdown:

- Have a strategic spare program for key components (e.g. gears)
- On-line vibration monitoring, over-speed safeguards and a safe trip system should be provided.
- Ensure a minimum WT protection function against the following events (control function failure): overspeed, generator overload or fault, excessive vibration, abnormal cable twist (due to nacelle rotation by yawing), loss of electric power used for the control function (provide an alternate source of power and UPS, fail safe system, etc.).

Corrosion:

- Adequate design and materials should be used for a given location (e.g. marine, non-marine, other).
- Adequate corrosion monitoring and protection programs should be established for a given technology / equipment in a given area.

Fire hazard:

- Use non-combustible or fire-resistant material for the nacelle or install a fire-resistant lining inside the nacelle to reduce fire exposure. Separate the nacelle from the tower with a non-combustible construction and provide non-combustible separation for the access points.
- Protection for controls and lubricating oil:

Client Guidance Note – Risk Control Practice

- Use of non-combustible fixed piping or flexible hose with adequate support in drains or guard piping or inside steel welded enclosure designed to return oil leakage to a protected collection point.
- Use less combustible approved (FM) hydraulic fluid in the turbine control system rather than combustible mineral oil (consult the Original Equipment Manufacturer in selecting suitable FM fluid) or provide containment as per FM Global Data Sheet 7-83 (limiting burning oil from spreading throughout the nacelle, prevent oil from spreading outside any equipment enclosures, prevent the possibility of oil flow into the tower) and when possible, install an automatically activated fire protection system flooding the nacelle (clean agent as per NFPA 2001) or local fire protection (gaseous or powder as a preferred double shot for reliability).
- Cables should be protected against exposure and adequately grouped. All cable openings should be sealed with FM-approved / UL-listed intumescent sealant.
- Install only dry-type electric equipment (e.g., transformers and breakers) in both the nacelle and support tower or install an automatic fire protection (see section 11 «Support for Loss Prevention Recommendations»)
- Provide an approved and adequate fire detection system in the nacelle and in the support tower housing hydraulic / electric equipment with an alarm supervision and relay to a constantly manned location.
- Provide visible and accessible Portable Fire Extinguishers in the nacelle and at the base of the tower.
- Provide ignition source control through a hot work permit (FM Global Data Sheet 10-3), housekeeping policy and Non-Smoking Policy.
- Collector and substation of the WT farm should be adequately protected (see section 11 «Support for Loss Prevention Recommendations»).

Develop a Contingency Plan and Business Continuity Plan in case of a major loss in order to mitigate BI and CBI exposure (e.g., loss of a third party operated substation, loss of connection to the grid or loss of power supply for the initial starting sequence of machinery and equipment prior to the initial start and/or after the shut-down / maintenance period and/or for controlling machinery and equipment depending on design).

2. WE - LOSS EXPERIENCES

Transport:

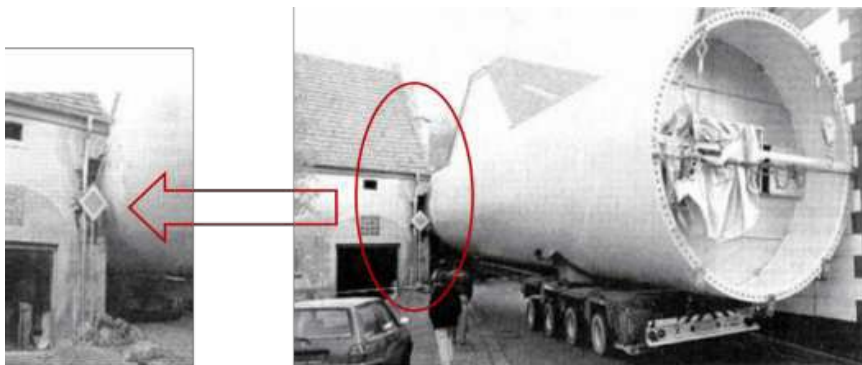

Lack of preparation prior to transportation leading to damages on transported equipment and on third party property.



This incident occurred in France where a van hit the tip of the blade while it was being transported by road. Subrogation ensued as the Transport Company was not compliant with laws relating to wide loads.

Erection:



The supporting platform surface was not wide enough for the nacelle and crane supports and there was insufficient ground compaction for the erection platform. This resulted in damages to the nacelle when the crane tilted. Erection operations were stopped until the ground compaction was checked at ALL the WTGs under erection at the wind farms. ALOPS reported.

Fire:



Origin above could be electrical or by ignition of oil in hydraulic system. Given the height of the tower (from 75 to 150 meters), the fire brigade will let the fire consume the NACELLE.



Origin above could be over-speed of the gear



The wind turbine generator (WTG) above was in the middle of a storm with high wind conditions. A power outage occurred at the wind park for 7-8 hours. There was no control system to guide the WTG and no control on the hydraulic system of the disc brake. When the emergency back-up batteries ran out the WTG was in the middle of high winds but jammed by a blocked brake disc. A hydraulic oil tube broke and sprayed oil on the hot disc and the subsequent fire destroyed the turbine in minutes.





Short circuit in the main control panel above.



The WTG transformer above was located in the middle of the tower and fire broke out due to over-voltage and protections failure. Smoke damage ensued in the tower and nacelle above.



© SCOR Claims Marc Godfrey

A power panel short circuit occurred above.

Design defect: incorrect distances between bars in the main switch and between the bars and panel. Several claims were generated. The series clause applied.

Wind:



Source: Google image labeled for reuse

Over-speed during strong wind conditions led to high vibrations and disintegration as shown above.



© SCOR Claims Marc Godfrey

Wind studies (maximum speed of gust of wind in a specific 10/20/30 years return period) and geotechnical studies (of foundations) as well as faulty design (in material) are important in order to avoid this kind of loss.

Tropical storm:

Chinese typhoon Usagi knocks out 17 wind turbines on 25 September 2013:

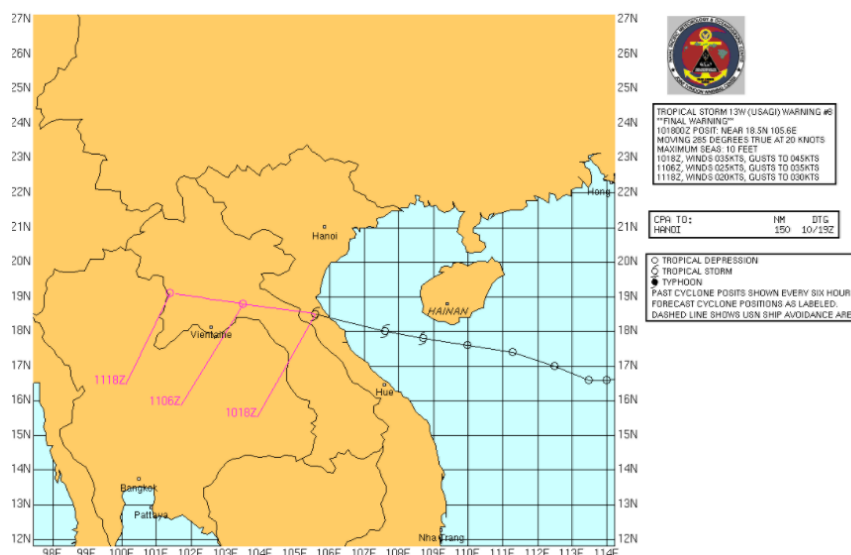

Eight wind turbines were blown down by typhoon-strength winds in south China's Guangdong Province.

Typhoon Usagi, the most powerful this year, also broke off blades in another nine wind turbines when it hit a Wind Farm in coastal Shanwei City, Guangdong.

The wind farm consists of 25 imported 600kW turbines. The remaining wind turbines need maintenance to see whether they can operate normally. Typhoon Usagi knocked out 70 per cent of the wind farm.

According to the manager of the wind farm, the typhoon has led to nearly CNY 100 million (\$16 million) of loss to the wind farm. The wind farm was hit by a similar typhoon in 2003, with 13 out of 25 turbines damaged causing a 10-million-yuan loss.

The wind farm was developed by the local Wind Energy Company in 2000 in Honghaiwan (Honghai Bay). The first stage of the project began operating in 2003, totaling 16.5MW. It was expanded with another 20.4MW in 2004.

China Typhoon* Rammasun on July 20, 2014:

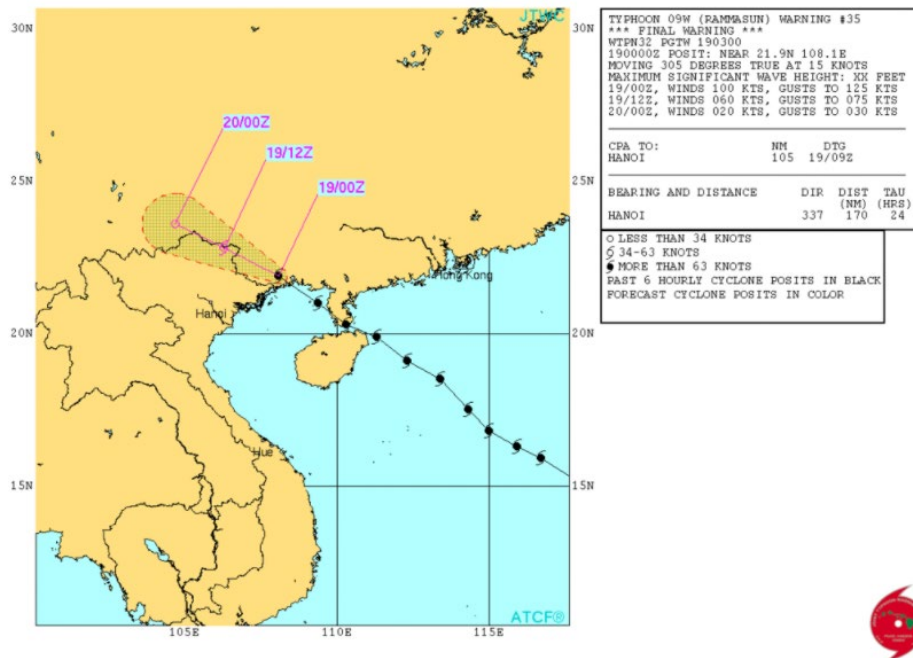

Source: Google image labeled for reuse

On the evening of the 18th, Typhoon Rammasun landed at Xuwen, Guangdong Province. 25 Wind Turbines were hit and survived in the strongest typhoon seen in 40 years.

The landing position of Rammasun is right near a Wind Farm with 25 Typhoon Model wind turbines, which were reportedly designed to survive extreme wind speeds of 70m/s. Before Rammasun landed however, the project office had already immediately triggered the emergency plan thus precious data was able to be collected during the typhoon strike. The last recorded data before the power-off shows an extreme wind speed of 61.5m/s. According to local meteorological records it is thought that the extreme wind speed of Rammasun exceeded 70m/s.

After Rammasun blew over, the engineers at the wind farm carried out a comprehensive inspection of all 25 turbines and no damage was found.

Still, Typhoon Rammasun caused severe damage to other wind farms nearby “killing” hundreds of HAWTs (Horizontal Axis Wind Turbines) on Hainan Island in China.

Lightning:



Source: Google image labeled for reuse

It is estimated that each generator may be struck 5 to 10 times a year.

Hail:

Carbon or plastic-based blades are very sensitive to hailstone impact. The impact depends on the hailstone size - from 2,5 up to 10cm diameter hailstones may result respectively in a 75, 115 or even a 160km/h vertical velocity.

Machinery breakdown – gearbox:



© SCOR Claims Marc Godfrey

As of the fifth year, these kinds of losses are more common.

Fire – substations:

Major losses arising from damages to substations are very frequent leading to a severe impact on BI or CBI cover due to the inability of the plant to deliver electricity to the T&D grid.

3. WE - LOSS ESTIMATES

Definitions:

Maximum Possible Loss (MPL): The MPL – Maximum Possible Loss – is the estimate in monetary terms of the largest loss which can be expected as a consequence of an insured event. It corresponds to the worst-case scenario after due consideration of all possible events or combination of events, in particular:

- Fire: all fire protection systems are inoperable, manual fire-fighting efforts are ineffective and fire can only be stopped by an impassable obstacle or by the lack of continuity of combustible materials.
- All Other Losses: all possible scenarios must be considered in addition to fire and explosion, in particular, natural perils (earthquakes, storms, and floods), civil commotion and man-made catastrophes.
- For the explosion scenario in petrochemical-related industries, a software program is used to determine the damage following a Vapor Cloud Explosion.

The MPL calculation includes PD, BI and interdependencies between sister plants where relevant. Neighboring exposure and CBI should be notified within the scenario where relevant. See § Accumulation.

Normal Loss Expectancy (NLE): SCOR's NLE is the consequence of an accident, which occurs when all the loss-limiting systems provided to minimize the consequences of that accident, function to achieve the results intended. An assessment should be based on a single fire event unless another greater relevant exposure exists.

See the MPL Handbook for details on terminology, scenario, and methods.

Scenarios:

Maximum Possible Loss (MPL):

Onshore:

- Total loss of one or more wind farms, involving each one or several groups of WTs, due to the failure of foundation(s) not incorporating an adequate level of seismic design within a seismically active area.
(i.e., to be considered when there is no evidence of structural load studies which should have been implemented prior to construction and factored into the design).
- Total loss of one or more wind farms, each involving one or several groups of WTs, due to Bushfire / Wildfire (* see note below) resulting in PD and BI (see section II.2 for loss experiences).

(* Note on Wildland Fire/Bushfire Exposure: Wildland Fire Exposures (assessment as per FM Global Data Sheet 9.19 Wildland Fire/Bushfire Exposure):

- As per local maps showing the zones that are exposed to wildland fire
- As per history when available
- If there are no local maps use the following distances as a guide to judge whether there is an exposure:
 - Within 800m (0.5 miles) of any forest
 - Within 30 m (100 ft) of grasslands

There are three ways a wildland fire can damage a building:

- Flying embers blown by the wind can land on and ignite combustible external elements of the WT construction. This is the most common ignition source.
- Fire can spread right up to the tower of the WT so there is direct flame impingement.
- The heat radiated from the height of the flames can raise the temperature of the exposed WT components causing them to reach their auto-ignition point.
 - Topography: a site (wind farm) built on a slope is more exposed to wildfire.
 - Combustibility of WT components is a key factor
 - Adequate clearance zone for WTs is required as follows:
 - a minimum of 30 m (100 ft) from grassland (trees up to 2m high) exposure,
 - and 100 m (330 ft) from shrubland (trees up to 8m high), woodland (trees up to 30m high), or forest exposure (trees 30-50m high).

Total loss of a critical transformer / converter (and related substation):

- Consider that an onshore transformer / converter is connected to several independent onshore WT parks and damage caused by this loss could easily trigger a BI loss in all the connected WT parks.
- This would require up to 18 months for replacement.

Onshore / Offshore:

- Total loss of one or more wind farms involving one or several groups of WTs due to a tropical storm / winter storm, tsunami, hail, earthquake and resulting in PD and BI (see section II.2 for loss experiences).
- Machinery Breakdown (onshore / offshore): serial losses due to the failure of the gearbox or other critical components of the WTs (that may result from faulty design or faulty workmanship et al.).

Offshore:

- With regard to the MPL for the German wind turbine offshore market, PML/MPL worst case scenarios have been discussed within the insurance industry for offshore wind farm parks in the North Sea as follows:
 - Marine vessel impact: a large vessel loses control during a very large storm at sea, collides with a wind park and destroys up to 40 to 50 %. For example, an offshore wind park consists of up to 80 wind turbines with a value of up to 1 billion Euros.
 - The damage caused by a non-maneuverable vessel can cause damages of up to 300 or 400 million Euros.
 - Munich Re's Storm Scenario (northern Europe exposed to extra tropical storms or winter storms).

MPL PD:

- Consider the high value concentration of several wind parks in the North Sea. A storm scenario might have major impacts depending on the speed of the storm.

MPL BI:

- Consider that damages to offshore WTs may trigger a BI loss of 6 to 8 months.
- BI must also be considered for repairing offshore wind turbines, as good weather and special barges are required.



- Total loss of a critical transformer / converter (platform): Considering that an offshore transformer / converter is connected to several independent offshore WT parks, the accident may easily trigger a BI loss for all the connected WT parks that suffer damages (up to 18 months for replacement).

Normal Loss Expectancy (NLE):

Onshore:

- Total loss of one of more WTs due to bushfire / wildfire (* see note below) resulting in PD, BI.
(* Note on Wildland Fire/Bushfire Exposure: Wildland Fire Exposures (assessment as per FM Global Data Sheet 9.19 Wildland Fire/Bushfire Exposure):
 - As per local maps showing the zones that are exposed to wildland fire
 - As per history when available
 - If there are no local maps use the following distances as a guide to judge whether there is an exposure:
 - Within 800 m (0.5 miles) of any forest
 - Within 30 m (100 ft) of grasslands

There are three ways a wildland fire can attack a building:

- Flying embers blown by the wind can land on and ignite combustible external elements of the WT construction. This is the most common ignition source.
- Fire can spread right up to the tower of the WT so there is direct flame impingement.
- The heat radiated from the height of the flames can raise the temperature of the exposed WT components causing them to reach their auto-ignition point.
 - Topography: a site (wind farm) built on a slope is more exposed to wildfire
 - Combustibility of WT components is a key factor
 - Adequate clearance zone for WTs is required as follows:
 - minimum of 30 m (100 ft) from grassland (trees up to 2m high) exposure,
 - and 100 m (330 ft) from shrubland (trees up to 8m high), woodland (trees up to 30m high), or forest exposure (trees 30-50m high).

Onshore / Offshore:

- Total loss of a WT including support tower (except foundation) due to fire involving oil-filled transformer located inside the support tower and spreading vertically to the upper part.
- Total loss of a WT nacelle and blade and upper part of support tower damaged due to a fire involving hydraulic oil in a nacelle.
- Total loss of the WT farm collector system and substation due to fire and resulting in at least 4 months BI, or more in the case of specially designed electrical equipment.
- Machinery Breakdown - (potential serial loss): blades, gearbox, generator (or operations). Also consider different life cycle periods and warranty damages caused by faulty design

. Offshore:

- Marine vessel impact with one or more WTs resulting in a total loss of the impacted WTs.



- Source: Google image labeled for reuse

- Remark: regarding offshore wind park farms, up to 70 % of the frequency losses is caused by erection / maintenance vessels (as shown below) servicing the sea cables
- The fact of applying one or more deductibles creates an interesting dynamic between the insured and the insurer.

Accumulation:

- The above MPL and NLE scenarios may apply to different insureds located in the same area resulting in BI and potential CBI accumulation. (A clear definition of ‘Client’ is required: the client must be identified as the owner of the substation to which the insured sells the electricity – a true bottleneck). This potential accumulation and Contingent Business Interruption (CBI) must be taken into account for underwriting purposes (“one risk definition” – please refer to the client guidance note Loss Estimate – MPL Handbook).

4. WE - UW CONSIDERATIONS

4.1. Warning

Renewable energies are still under development and new risks, including new special hazards and exposure, may arise in the near future resulting in a deviation from the current occupancy guidelines.

4.2. UW Risk Assessment – Engineering – Onshore Wind Farms

Definition (Risk perimeter i.e., WTs, Wind Farms including other critical facilities, groups of wind farms, etc.):

“one risk” as defined as per the policy. This may include (but is not limited to)

- One WT or a group of WTs in the same wind farm
- Connected to the same substation (via UG/AG/overhead cables). This can be part of the risk or not (third party). E.g., national grid / private operator
- Including (or not) a connection to the grid (transmission line)
- In the same manner, several wind farms may be part of “one risk” having different sites (but the same insured). A case has been reported of claims made involving damage due to windstorms at different locations on the same day. As the policy defined the various farms as 1 risk, then only 1 deductible was applied. It can become even more
- complicated when the distance between wind farms and meteorological data show different storm systems, i.e., individual windstorms albeit on the same day.

Exposure / Special Hazards / Loss Estimates:

- Exposure, Special Hazards: see section II.1- WE - Risk Control Topics
- MPL: see section II.3- WE - Loss Estimates

UW Methodology (Risk analysis process):

- Quality of specialized workforce
- Logistics: access to assembly site: blades (up to 50 m length, 15 tons weight), heavy cranes
- Fire risk (protection measures)
- Liability
- Erection equipment
Weather (snow, hail and speed of gust of wind when the tower and blades are being assembled)
- Proven equipment, no prototypes (see note 1 end of section)

4.3. UW Risk Assessment – Engineering - Offshore Wind Farms

Definition (Risk perimeter i.e., WTs, Wind Farms including other critical facilities, groups of wind farms, etc.):

“one risk” as defined as per the policy. This may include (but is not limited to)

- Wind farm / parks offshore policies covering only one of the following:
 - a) a subsea cable / grid
 - b) the platform of the WT itself
 - c) the wind turbine
 - d) the transformer and converter or both
 - or also a complete package
- In the same manner, several wind farms / parks may be part of “one risk” having different sites (but the same insured).

For German & Northern Europe market:

- Consider a risk exposure accumulation of: platform, WT, subsea cable and transformer.
- Offshore WT farms are quite sophisticated, and technology is always looking for bigger sized and longer turbine blades.
- 6 MW and even 9 MW are under design and can still be considered as non-proven technology.

Exposure / Special Hazards / Loss Estimates:

- Exposure, Special Hazards: see section II.1- WE - Risk Control Topics
- MPL: see section II.3- WE - Loss Estimates.

UW Methodology (Risk analysis process):

- Quality of specialized workforce
- Logistics: access to assembly site: blades (up to 50 m length, 15 tons weight), heavy cranes.
- Fire risk (protection measures).
- Liability
- Erection equipment.
- Weather (snow, hail and speed of gust of wind when the tower and blades are being assembled).
- Proven equipment, no prototypes (see note 1 end of section).

Risk exposure is different from onshore. With regard to offshore, it is generally a question of wind farm parks and not just a single wind turbine. For exposure, the following factors need to be taken into consideration (in addition to onshore factors as listed above):

- Near coastline (< 10 km – sea elevation < 10 meters deep)
- Far coastline (> 10 km) - sea elevation > 10 - 40 meters deep)
- Underwater (sea) cable / grid (installation and Liability)
- The platform of the WT itself
- The transformer; vessel impact; corrosion
- Sea action (waves and tides); availability of specialized vessels
- Weather conditions both for access to the site and for erection; increased exposure to lightning.

4.4. UW Risk Assessment – Property – Onshore Wind Farms

Definition (Risk perimeter i.e., WTs, Wind Farms including other critical facilities, groups of wind farms, etc.)

“one risk” as defined as per the policy. This may include (but is not limited to)

- One WT or a group of WTs in the same wind farm
- Connected to the same substation (via UG/AG/overhead cables). This can be part of the risk or not (third party). e.g., national grid / private operator)
- Including (or not) a connection to the grid (transmission line)
- In the same manner, several wind farms may be part of “one risk” having different sites (but the same insured). A case has been reported of claims made involving damage due to windstorms at different locations on the same day. As the policy defined the various farms as 1 risk, then only 1 deductible was applied. It can become even more complicated when the distance between wind farms and meteorological data show different storm systems, i.e., individual windstorms albeit on the same day.

Exposure / Special Hazards / Loss Estimates:

- Exposure, Special Hazards: see section II.1- WE - Risk Control Topics
- MPL: see section II.3- WE - Loss Estimates.

UW Methodology (Risk analysis process):

- Quality of specialized workforce
- Logistics: access to assembly site: blades (up to 50 m length, 15 tons weight), heavy cranes.
- Fire risk (protection measures)
- Liability
- Erection equipment
- Weather (snow, hail and speed of gust of wind when the tower and blades are being assembled).
- Proven equipment, no prototypes (see note at the end of 4 WE - UW CONSIDERATIONS).

4.5. UW Risk Assessment – Property – Offshore Wind Farms

Definition (Risk perimeter i.e., WTs, Wind Farms including other critical facilities, groups of wind farms, etc.):

“one risk” as defined as per the policy. This may include (but is not limited to)

- Wind farm / parks offshore policies covering only one of the following:
 - a) Sea cable / grid,
 - b) the platform of the WT itself,
 - c) the wind turbine,
 - d) the transformer and converter or both,
 - or also a complete package.
- In the same manner, several wind farms / parks may be part of “one risk” having different sites (but same insured).

For German & Northern Europe market:

- Consider a risk exposure accumulation of platform, WT, subsea cable and transformer
- Offshore WT farms are quite sophisticated, and technology is always looking for bigger sized and longer turbine blades
- 6 MW and even 9 MW are under design and can still be considered as non-proven technology.

Exposure / Special Hazards / Loss Estimates:

- Exposure, Special Hazards: see section II.1- WE - Risk Control Topics
- MPL: see section II.3- WE - Loss Estimates.

UW Methodology (Risk analysis process):

- Age, life duration: for MB some components have a shorter life cycle than others i.e., gearbox v. generator etc...
- Fire risk (protection measures)
- Machinery breakdown (terms and conditions of maintenance contracts with manufacturer of equipment or with recognized engineers)
- Machinery breakdown and MB BI: availability of spare parts (gearbox, transformers, inverters, ...)
- Electric risk
- Lightning
- Technological risk: new replacement value for equipment less than 10 years old
- Weather (hail, ice in blades, max. speed of gust of wind)
- Prototypes: serial loss clause (see notes 1 and 2 end of section).

Risk exposure is different from onshore. With regard to offshore, it is generally a question of wind farm parks and not just a single wind turbine. For exposure, the following factors need to be taken into consideration (in addition to onshore factors as listed above):

- Near coastline (< 10 km – sea elevation < 10 meters deep)
- Far coastline (> 10 km - sea elevation > 10 - 40 meters deep)
- Underwater (sea) cable / grid (installation and Liability)
- The platform of the WT itself
- The transformer; vessel impact; corrosion
- Sea action (waves and tides); availability of specialized vessels
- Weather conditions both for access to the site and for erection; increased exposure to lightning
- Costs of dredging and re-dredging incurred as a result of normal sea action. (Sea cables are buried up to 1.50 meters in the sea ground. Vessel anchors can damage sea cables up to 7 meters deep).

Notes

- Prototype:

We are aware that even industry specialists are not able to predict exactly whether every new technique or technology will be a proven or unproven project.

To be able to properly underwrite new and fast developing technology risks, the underwriter should have up-to-date information on the current state of the technology he would like to underwrite.

From a Claims perspective, a prototype is the model that gets tested before it goes into production. However, one may argue that the 1st version of something is a “prototype”, as in most cases it will be “enhanced” or “revised” at a later date to optimize / increase performance. The problem is how many 1st versions can be called “prototype” and when does one consider how long it is operational/generating before accepting it is not a prototype?

- Example:
 - 1st generation turbine that failed within the 1st year of operation.
 - 1st generation turbine that failed after 4 years of operation.
- Serial losses:

We have to consider that the main components of the wind turbine have a different life cycle (blades, gear box, generator etc.) which can differ during the operation from 4 to 10 years.

Please note that there is a fast-developing technology risk for:

- Gas turbines
- Wind turbines
- Solar panels

For gas turbines the insurance industry has agreed on special clauses with regard to unproven and proven technology. For example, the turbine is proven after 8000 working hours.

For wind turbines the parameters are different. We cannot consider the definition (proven technology) for the gas turbine (8000 hrs).

Wind turbines and solar panels seem to be in the midst of a period of fast development. The London Engineering group is working on a paper for a “Code of practice” to also address this issue.

Loss History:

Impact of loss per warranty in operations:

Type of loss	% number of loss	% cost of loss
Machinery	40%	40%
Lightning	20%	25%
Fire	7%	9%
Storm	4%	2%
Other (short circuit, ...)	29%	24%

Impact of loss per affected part of equipment:

Part of equipment	Impact of Loss
Tower	18%
Blades	17%
Gearbox	16%
Generator	10%
Transformer	8%
Control Equipment	5%
Other	13%

5. WE - CLAIMS CONSIDERATIONS

5.1. Onshore

Construction:

Wind turbine models applied by the manufacturer, who may be a co-stakeholder in the project, will give insight to the level of innovation applied. Often, we find getting access to information difficult as the manufacturer has already transported the turbine or gearbox back to their facilities. To manage the claim, immediate access by a consultant specialist is required.

Damage to blades during erection; most of the time this can be repaired on site, but the Insured prefers to supply a new blade (or 3 new blades). A repair procedure could, possibly, be agreed on. Note: Carbon blades cannot be repaired at all, especially after lightning flash damages.

BI / ALOP:

From an output objective it is important to look at Advance Loss of Profit in the construction phase, but also at the transfer to the operational phase to benefit from the output ability prior to hand-over.

When the hand-over is completed the manufacturing warranty and the Business Interruption require attention to avoid any unwanted omissions.

The Business Interruption calculation is based on the contractual conditions and generally the readings of the output performance of adjacent wind turbines can be applied to reach a fair and reasonable adjustment.

The 10-minute average wind speed recordings are used to compare operational output between turbines.

It goes without saying that the optimum insurance for wind parks is a combination of Property, Machinery Breakdown and Business Interruption insurance, not forgetting Liability.

Monitoring and Maintenance (incl. Offshore):

In view of the height of the towers and the remote areas, proper distance monitoring and scheduled maintenance must be put in place to secure the optimum operational output.

It is recommended to run the maintenance cycles prior to and in line with the warranty period time-limitation per turbine.

Considering the generated electricity is to be fed to a grid and the policy covers the park itself then the risk or influences of a receptive grid need to be taken into account.

It is important to see the maintenance regime. In many cases this is only a visual inspection from the ground checking for blade damage. Make sure a maintenance schedule is completed. In order to reduce the loss frequency to the policy, an Extended Maintenance contract should be purchased by the operational company. The Maintenance Company that is monitoring the wind turbine park generally take action before a loss / damage occurs.

5.2. Offshore

Grouting

In 2010 it was discovered that hundreds of European offshore wind turbines have a design fault allowing them to slide on their bases. The problem involves towers using grouting, a mixture of cement, sand and gravel, to attach the turbines to their base.

In some cases, the main superstructure of wind towers has moved several centimeters on its base after being installed. It is an industry-wide problem related to a general design and not one particular tower model.

Corrosion:

Overall requirements for corrosion control (including design premises, functional requirements and operational aspects) should be addressed in a dedicated section (or document) of the design documentation.

Removal of Foundations:

We already hear about new offshore wind parks where the foundation is to be removed after the wind park is taken out of use. This is another interesting cost to the total operational model.

Civil code of practice for the wind turbine manufacturer: the design of the wind turbine should follow the codes (international agreement).

III – PHOTOVOLTAIC SOLAR ENERGY (PSE)

This section is limited to "large scale photovoltaic production systems" excluding "residential / local use".

1. PSE - RISK CONTROL TOPICS

Solar Photovoltaic Power Trends:

- Solar PV power is the world’s fastest growing energy technology. Solar PV production has increased significantly over the previous decade, increasing at an average annual rate of almost 50% since the beginning of the 21st century. The majority of this increase in capacity is the result of the installation of the large, grid-connected systems.
- Growth is expected to continue in the future, as the average installed costs decrease and various government entities provide tax credits, loan programs, and other incentives to stimulate investment in the technology.
- Although the rate of growth has slowed recently due to decreased government incentives, industry growth is still expected, as shown in the Table below.

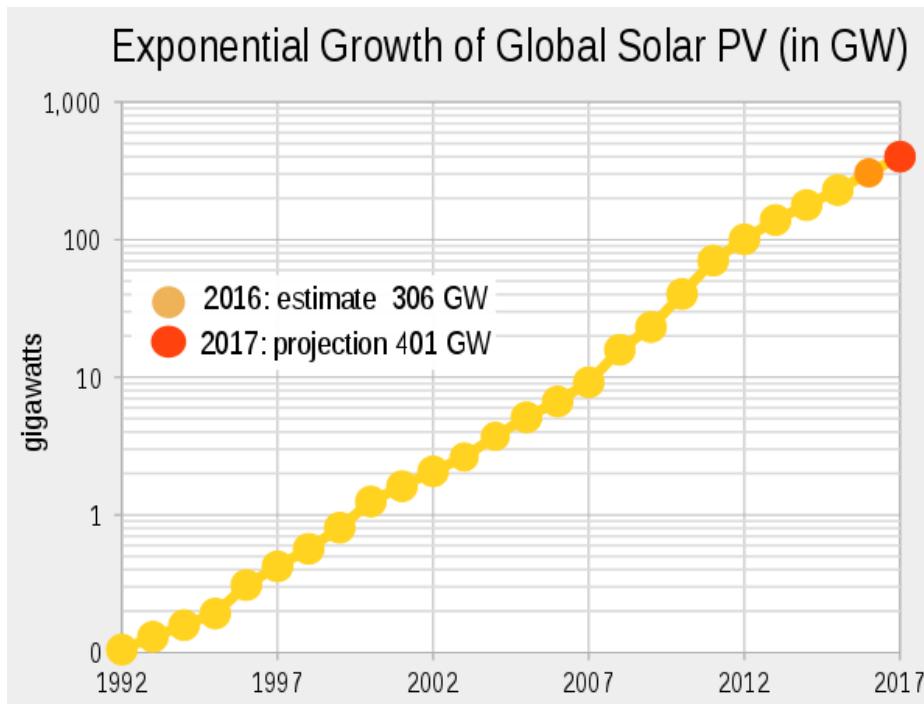

Business Models:

There are mainly 2 business models:

- Proprietary systems: owned and operated by the property insured, producing electricity for its proper use and/or producing electricity to be sold to the grid. This could be declared as BI- “energy sells” for insurance purposes and leads to a very interesting claims adjustment process in the case of a loss given the difference in pricing electric power during high price and lower price periods. It will, of course, depend on the contract signed with the local / national grid.



- Third party owned & operated: most of these installations are done by a third party that rents surface at the facility to produce its own electricity. In this case, the installation standard and the consecutive maintenance of the panels is not the responsibility of the insured facility, but the responsibility of the third-party company.

Occupancy:

A photovoltaic power station, also known as a solar park, is a large-scale photovoltaic system (PV) designed for the supply of merchant power to the electricity grid. They are differentiated from most building-mounted and other decentralized solar power applications because they supply power at the utility level, rather than to a local user or users. They are sometimes also referred to as solar farms or solar ranches, especially when located in agricultural areas.

Solar fields

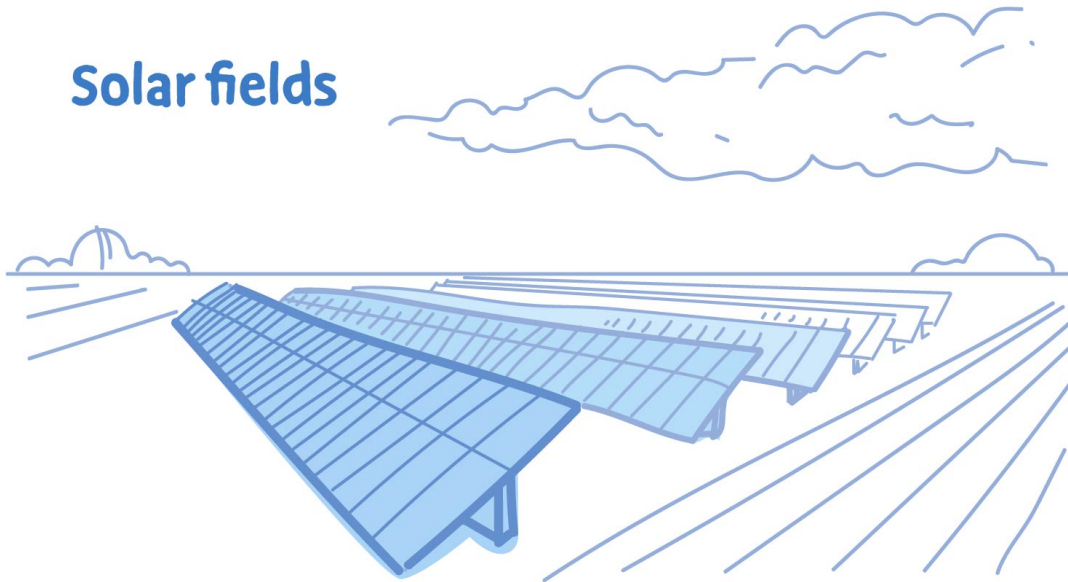

Most of the existing large-scale photovoltaic power stations are owned and operated by independent power producers, but the involvement of community or utility-owned projects is increasing. To date, almost all have been supported, at least in part, by regulatory incentives such as feed-in tariffs or tax credits, but capital costs have fallen significantly in the last decade and are expected to progressively reach grid parity, when external incentives may no longer be required.

Major Technologies:

There are basically two major technologies: Concentrated photovoltaic (CPV) and Non-Concentrated Photovoltaic (or PV) and as described below:

- Concentrated photovoltaic (CPV)** technology uses optics such as lenses or curved mirrors to concentrate a large amount of sunlight onto a small area of solar photovoltaic (PV) cells to generate electricity. Compared to non-concentrated photovoltaics, CPV systems can save money on the cost of the solar cells, as a smaller area of photovoltaic material is required. Because a smaller PV area is required, CPVs can use the more expensive high- efficiency tandem solar cells. To get the sunlight focused on the small PV area, CPV systems require spending extra money on concentrating optics (lenses or mirrors) and sometimes solar trackers, and cooling systems. Because of these extra costs, CPV is far less common today than non-concentrated photovoltaics. However, ongoing research and development is trying to improve CPV technology and lower costs. CPV also competes with concentrated solar thermal. CPV turns the sunlight directly into electricity, while solar thermal turns the sunlight into heat, and then turns the heat into electricity. Solar thermal (see next section 4) is far more common than CPV, although the two technologies are sometimes combined.
- Non-concentrated PV or PV:** The power conversion source is via photovoltaic cells that convert light directly to electricity as follows:

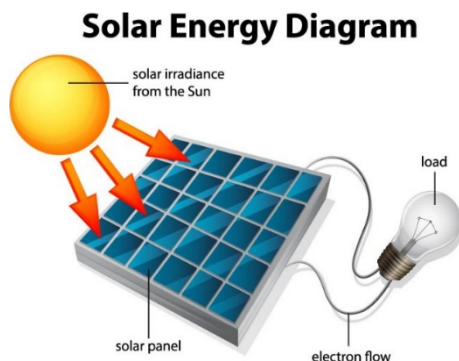

Principle

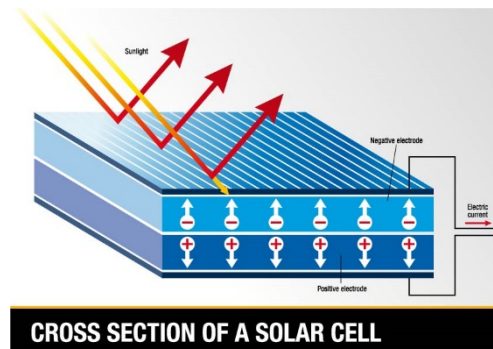

Close-up view

Photovoltaic cells are assembled in a solar module, then in solar panels forming Photovoltaic (PV) systems as follows:

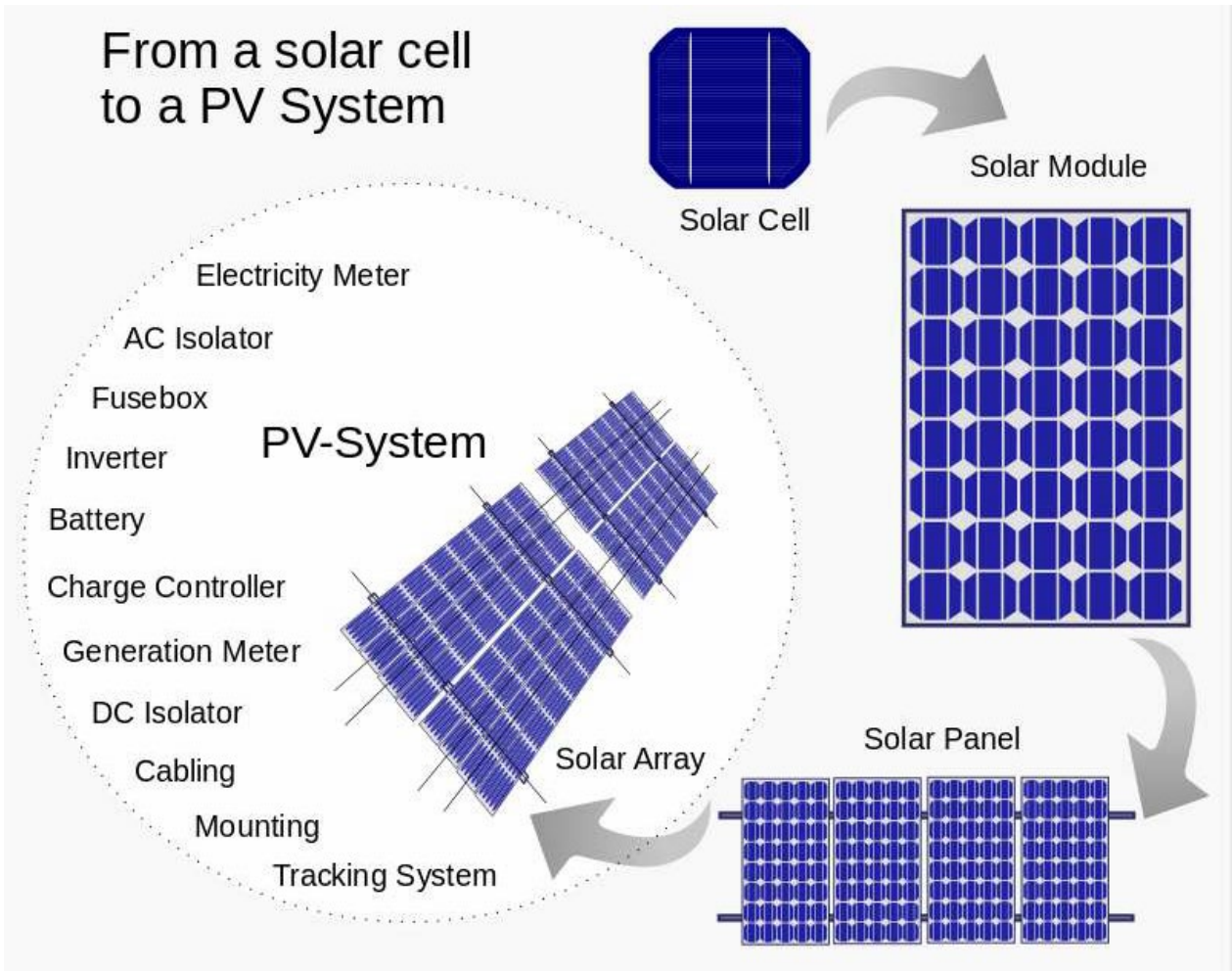

Source: Google image labeled for reuse

- Individual photovoltaic (PV) cells are constructed of a number of materials, including monocrystalline silicon, polycrystalline silicon, amorphous silicon, cadmium telluride, and copper indium gallium selenide.

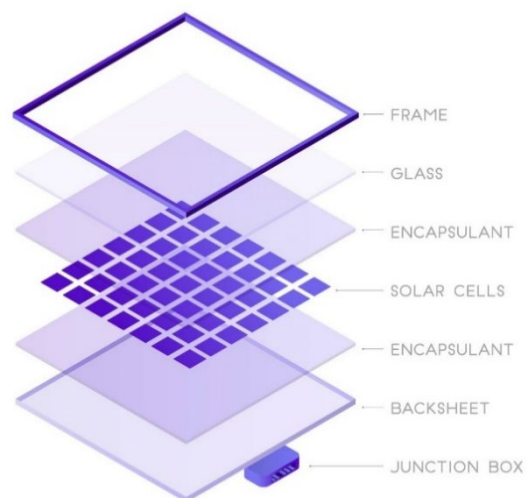
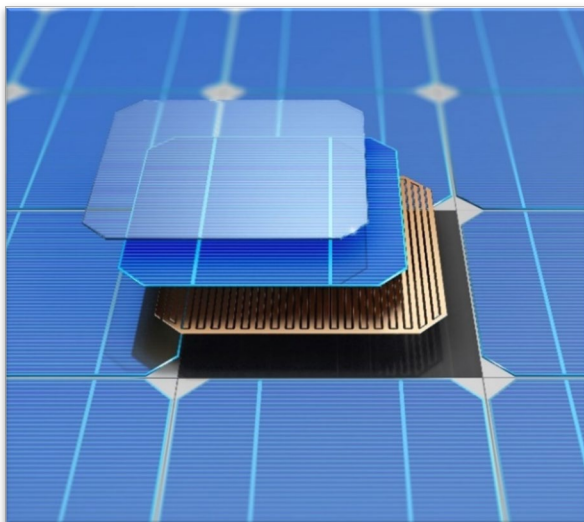

Client Guidance Note – Risk Control Practice

- Individual solar PV cells are wired in series and protected within (sandwiched between) a weather-resistant enclosure to form a module.
- The weather-resistant enclosure consists of heat-strengthened glass on the top
- and tempered glass on the bottom, with an anti-reflective coating provided on the top surface.
- Multiple modules are assembled together in a single plane to form a PV panel (the terms module and panel are used synonymously).
- An assembly of PV panels are then mechanically and electrically integrated, including a support structure and electrical connections and equipment, to form a solar array (PV system as shown below)
- The panels within the array convert energy from sunlight into direct current (DC) electrical power.
- This power is then distributed to the electrical grid. Generally, an inverter is used to convert the electric power from DC to alternating current (AC) (see next pages).

Well-designed and maintained PV systems are expected to operate for more than 20 years. For large installations, a primary concern is the impact of various natural hazards due to an aggregation of exposures within a single location. PV systems are subjected to weather conditions such as hail, rain, snow, ice, earthquakes, wind, storms and the potential damage can be substantial. Solar PV panels are generally very reliable. However, stressful environments, including desert conditions and high temperatures, can cause performance degradation. The annual rate of performance degradation resulting from normal operating conditions has been estimated between 0.5% and 2%. These rates may be exceeded in the event of a severe weather condition such as a hailstorm or sandstorm.

The warranty conditions for PV panels typically guarantee that panels can still produce at least 80% of their initial rated peak output after 20 (or sometimes 25) years. So, manufacturers expect that their panels will last at least 20 years and that the efficiency will decrease by no more than 1% per year.

Most solar parks use ground-mounted (sometimes called free-field or stand-alone) arrays. They can either be fixed tilting or tracking, single axis or dual axis. Tracking increases the output but also the installation and maintenance cost. Some PV systems are roof-mounted (mostly for residential / local use) as follows:



Ground-Mount (fixed)



Roof-Mount (fixed)



Track-Mount (mobile)

Source: Google image labeled for reuse

Client Guidance Note – Risk Control Practice

The solar arrays are the subsystems which convert incoming light into electrical energy. They are comprised of a multitude of solar modules, mounted on support structures and interconnected to deliver a power output to electronic power conditioning subsystems.

A minority of utility-scale solar parks are configured on buildings and so use building-mounted solar arrays. The majority are 'free field' systems using ground-mounted structures, usually of one of the following types:

- Fixed arrays: mounting structures where the solar modules are mounted at a fixed inclination calculated to provide the optimum annual output profile.
- Single axis / Dual axis trackers: solar panels are installed on a mobile structure provided with one / two-axis trackers, capable of tracking the sun in its daily orbit across the sky and as its elevation changes throughout the year.

Solar panels produce direct current (DC) electricity, so solar parks need conversion equipment to convert this to alternating current (AC), which is the form transmitted by the electricity grid. This conversion is done by inverters: The DC power output of the solar arrays is converted to AC by inverters and connection to the grid is through a high voltage three-phase step-up transformer, usually to 10 kV (or above) as shown below:

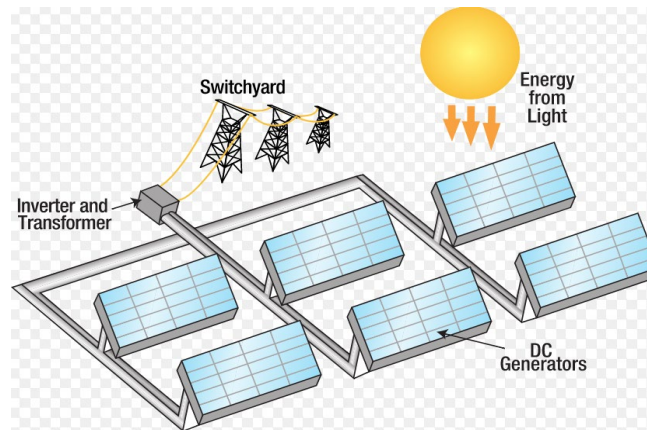

Here are two primary alternatives for configuring the conversion equipment; centralized and string inverters, although in some cases individual or micro-inverters are used.



Source: Google image labeled for reuse

- Single inverters allow optimizing the output of each panel, and multiple inverters increase the reliability by limiting the loss of output when an inverter fails.
- Centralized inverters: These units have a relatively high capacity, typically of the order of 1 MW, so they condition the output of a substantial block of solar arrays, up to perhaps 2 hectares in surface area.
- String inverters: String inverters are substantially lower in capacity, of the order of 10kW, and they condition the output of a single array string.

Client Guidance Note – Risk Control Practice

Transformers: The system inverters typically provide power output at voltages of the order of 480 VAC. Electricity grids operate at much higher voltages of the order of tens or hundreds of thousands of volts, so transformers are incorporated to deliver the required output to the grid.



PV farm Substation



Power Transformer

For surface-mount panels (residential /industrial & commercial local use) connection to the grid is through a fuse box without a power transformer, as shown below:

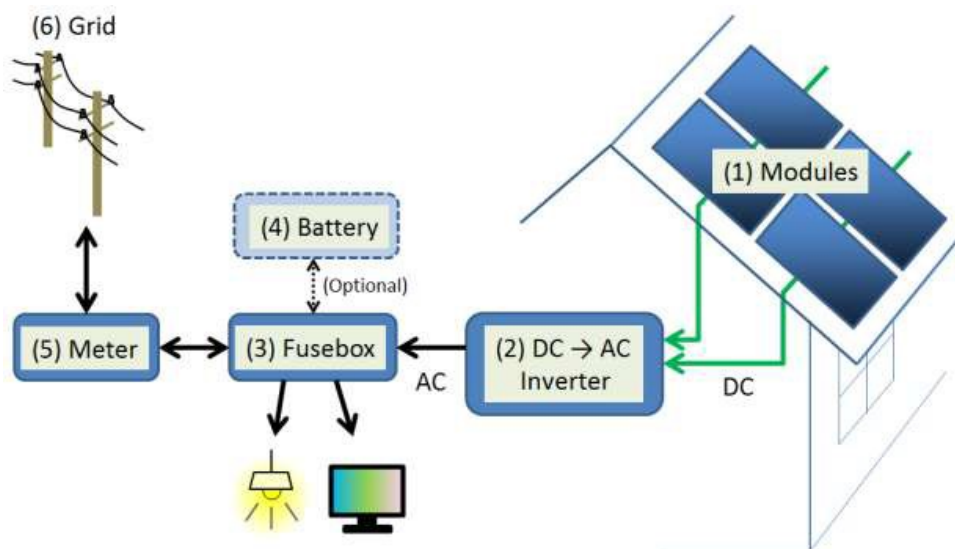

Source: Google image labeled for reuse

Exposures (Ground-mounted):



Natural Perils:

- Hail impact on solar panels
- Snow, Rain, and Ice
- Wind on solar panels (big surfaces of solar modules - 250 m² (2800 sq ft) that behave as sails. The mechanical effort is transmitted to structures and tracking electrical engines: the torque transmitted to the gear teeth is huge (crown / pinion gear).
- Sand and dust storms
- Lightning for all equipment
- Earthquake
- Tsunami in coastal area
- Flood

Wildfire / Bushfire

Theft: copper cabling theft can affect several units.

There may be Contingent Business Interruption and potential accumulation when various clients of PV farm(s) are impacted when these farms cease operating.

Special hazards (Ground-mounted):

- Ground fault
- Loss of power for controlling process equipment
- Fire on electrical equipment also including oil-filled equipment (transformers) and Energy Storage Systems (see ESS section)
- Ground settlement
- Human Factor
- Supervision of property

Loss Prevention Recommendations (Ground-mounted):

Natural Perils:

- Hail: ensure panels are designed to withstand hail impact without damages. Use panels which have a hail rating such as those tested in accordance with FM4473 for respective hail-prone areas as defined as follows:
 - Very Severe Hail Area - Class 4 (2in., 50mm diameter ice ball)
 - Severe Hail Area- Class 3 (1.75in., 44mm diameter ice ball) or class 4 above
 - Moderate Hail Area – Class 2 (1 1/2in. or 38mm diameter ice ball), class 3 or class 4 above
- Snow, Rain, and Ice: Use solar panels and solar panel support structures that adequately support loadings associated with snow, rain-on-snow surcharge, and ice accumulation. Consider both strength and stiffness of the solar panels and solar panel support structures when determining adequacy to support snow, rain, and ice loading.
- Wind: ensure fixed panels are designed to withstand local extreme wind conditions without damages and ensure a safe positioning system for mobile panels in order to reduce wind forces on the system. Avoid locating ground-mounted solar panels in regions that are prone to tropical storms (such as hurricanes, typhoons and cyclones) and where the design wind speed is equal to, or faster than, 100mph (45m/s), as there is considerable potential for damage due to wind pressure and/or windborne debris.
- Sand and dust storms:
 - In desert environments (e.g., US), use solar panels that have passed the U.S. Department of Defense MIL-STD-810F, Test Method Standard for Environmental Engineering Considerations and Laboratory Tests, Test Method 510.4, “Sand and Dust.”
 - Provide on-site or portable resources, including a water supply and small hose, for cleaning PV panels as needed to minimize reductions in power generation.
- Lightning is a common cause of failures in photovoltaic (PV) and wind-electric systems. It can cause a damaging surge that strikes far away from the system, or even between clouds. However, most lightning damage is preventable through:
 - Adequate grounding & bonding: An electrical path-to-ground will constantly discharge static electricity that accumulates in an above-ground structure. Often, this prevents attracting lightning in the first place. Step one in grounding is to construct a discharge path-to-ground by bonding (interconnecting) all the metal structural components and electrical enclosures, such as PV module frames and mounting racks.
 - Lightning arrestors and surge protectors are designed to protect electronic equipment by absorbing electrical surges. However, these devices are not a substitute for good grounding. They function only in conjunction with effective grounding. The grounding system is an important part of your wiring infrastructure. Install it before or while the power wiring is being installed. Otherwise, once the system is working, this important component may never get checked off on the “to do” list.
- Earthquake: Design and construct all buildings and structures, equipment anchorage, support frames and foundations, tanks, piping-system bracing and nonstructural elements to resist maximum local expected earthquake forces.
- Flood: PV panels should not be located in a flood zone. Studies prior to installation should be conducted and well documented.

Ground Fault:

- A ground fault in PV arrays is an accidental electrical short circuit involving the ground and one or more normally designated current-carrying conductors. Ground faults in PV arrays are safety concerns because they may generate DC arcs at the fault point on the ground fault path, damage surrounding insulation and create fire hazards. The risk of fire hazards is escalated substantially if a second ground fault develops. A DC ground fault is a common fault in PV systems and may be the result of the following:
 - Insulation failure of cables (e.g., an animal chewing through cable insulation and causing a ground fault).
 - Incidental short circuit between the normal conductor and ground (e.g., a cable in a PV junction box incidentally coming into contact with a grounded conductor).
 - Ground faults within PV modules (e.g., a solar cell short circuiting to grounded module frames due to deteriorating encapsulation, impact damage, or water corrosion in the PV panel).
- To properly protect PV arrays from ground fault damage and ensuing fire hazards, NFPA 70, *National Electrical Code*, Article 690.5(A), specifies that the ground fault protection device (GFPD) or system must be capable of detecting a ground fault current, interrupting the flow of the fault current and providing an indication of the fault. According to recent industry experience, there are some cases where the first ground fault could not be detected by the current design GFPD (such as applying a fuse in the grounding electrode). A second ground fault occurred allowing the fault current to flow into the array leading to fire incidents.
- Sophisticated techniques such as residual current monitoring to measure the imbalance of current flow in the positive and negative feeders from the inverter to each combiner box are being developed to detect ground fault protection.

Loss of Power for controlling process equipment:

- Provide an emergency source of uninterruptible power for the solar panel control system if loss of the control system could be dangerous.
- Alternatively, provide a fail-safe system that will position the panels in a safe position upon loss of power.
- Provide an alternate means of power for the solar panel control system if it is critical to maneuver the panels into a safe position during a windstorm or hailstorm.

Fire:

- The types of materials used in ground-mounted solar panels may not necessarily be likely to propagate a fire. However, they may be damaged when exposed to fire. Such damage could occur when exposed to radiant heat or burning embers from a bushfire or wildland fire, or nearby combustible construction or outside storage. While damage may be limited to cracking of the glass covering or thermal damage to the panels below, it may prevent or limit generation of electrical power.
- Wildfire / Bushfire: Provide adequate space separation and protection from wildland fires and bushfires in accordance with Data Sheet 9-19, Wildland Fire/Bushfire Exposure, and from combustible yard storage or inadequately protected adjacent buildings in accordance with Data Sheet 1-20, Protection Against Exterior Fire Exposure (see note on section 3.3 Loss Estimates).
- Prefer PV modules mounted on non-combustible frames. Do not use solar PV systems that contain foam plastic, such as extruded foam polystyrene, unless specifically FM-approved for exterior fire exposure. Install panels with a Class A or B rating in the Spread of Flame test, and a Class A or B rating in the Burning Brand test when tested in accordance with ASTM E108, Standard Test Methods for Fire Tests of Roof Coverings.
- Aggravating factors: fire fighters may refuse to fight fires involving PV due to electrocution hazards as panels cannot be "switched off" (e.g., Germany and some states in the US and elsewhere).
- Fire protection of electrical equipment (electrical room, substation, panels, transformers) in accordance with section XI

Settlement:

- Ensure there are proper foundations for either fixed or mobile PV systems.

Human Factor:

- *Emergency Response and Pre-Incident Planning:* Design and institute an emergency response plan (as per NFPA or FM Global Data Sheet). Include potential fire scenarios in the emergency response plan.
- *Pre-Incident Planning with the Public Fire Service:* Due to the remote location of solar power facilities, the fire-fighting response may be delayed. Therefore, pre-incident planning with the fire service is critical. Arrange and prepare documented procedures to expedite access and emergency responses to events such as fire. Prepare schematics to guide responders and indicate the location of access routes throughout the facility. Train and authorize designated personnel to serve as liaisons with the public fire service. Provide the local fire service with sufficient knowledge of fire hazards and response procedures to aid them in conducting fire-fighting operations. Document this information in the pre-incident plan with the local fire service.
- *Hot Work:* Establish a hot work permit and supervision program.

Supervision of Property:

- Provide protection against potential theft or vandalism. This could include, but is not limited to, any of the following: the use of security fencing, exterior lighting, continuous employee attendance and security services.
- The level of protection needed will vary depending on the value of the facility.

BI/CBI:

- Develop a Contingency Plan and Business Continuity Plan in case of a major loss to mitigate BI and CBI exposure (e.g., loss of the third party operated substation, loss of connection to the grid, loss of power supply for the initial starting sequence of machinery and equipment prior to the initial start and/or after the shut-down / maintenance period and/or for controlling machinery and equipment depending on design).

SCOR Risk Control Standpoint for Surface-Mounted PV:

(With thanks to Franck Orset, (FPO) Loss Prevention Engineer, for his invaluable contribution).

- As a first approach, Surface-Mounted Solar PVs are acceptable when installed on the ground floor or as solar car parks (but NOT for automotive / retail car parks) as there is no exposure to other buildings/equipment. Warning: Third Party Liability may apply in the case of mutual exposures between parked cars and the roof above equipped with Solar panels.

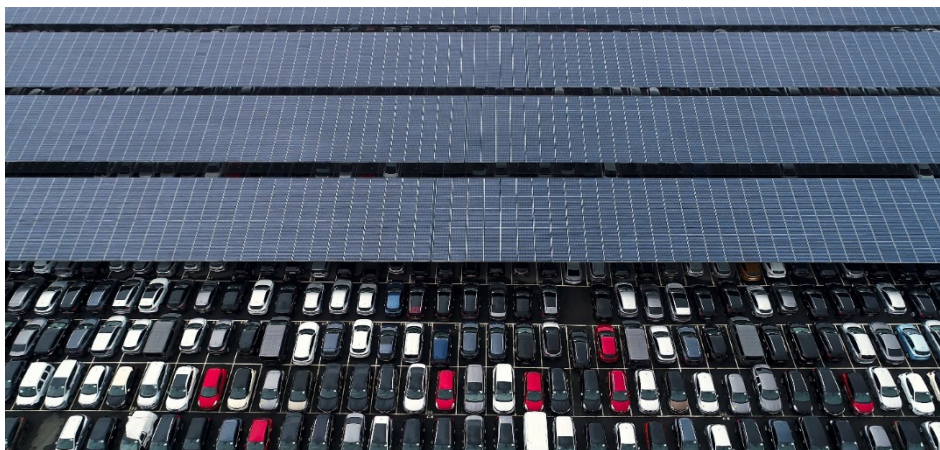

PVs exposing automotive retailer car park

Roof-Mounted Solar PV constitutes an aggravating factor to the building as follows:

- Electrical fires:
 - Adding a combustible load (combustible PV components)
 - Introducing a source of ignition (energized PV)
 - Electrical hazards associated with fire-fighting operations: Fire fighters may refuse to fight fire involving PV due to electrocution hazards as panels cannot be "switched off" (e.g., Germany and some state in the US and elsewhere).

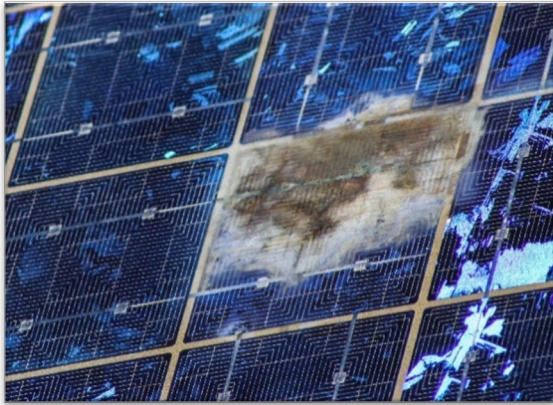

- Structural and weather hazards:
 - Additional weight on roofs
 - Possible exposure to other equipment on roofs
 - Wind, hail, snow, debris and extreme temperatures (introduce substantial loads to the panels and the roof through wind up-lift, thermal expansion and debris build-up)
 - Possible debris accumulation if poor housekeeping/ maintenance
 - Substantial loads can lead to the destruction of rooftops and PV systems.
- Norms & Standards:

In the US, should comply with:

 - NEC:** National Electric Code (installation)
 - NFPA:** National Fire Protection Association (installation)
 - FM:** FM Global Data Sheet 1-15 Roof-Mounted Solar Photovoltaic Panels (installation & products approval)
 - UL:** Underwriter Laboratories (PV product certification)
- Roof-Mounted Solar PV is acceptable when:
 - Only approved panels are used (recognized manufacturer, FM-approved, UL-listed)
 - Installation is performed by a recognized company
 - Installation on concrete roofs (combustible load limited to the outside membrane) or on roofs of buildings with: Roof assembly: FM-approved and or non-combustible, mineral wool insulation. (Go/No Go as per Authority Having Jurisdiction – AHJ – local / regional – to be considered)
And
Limited equipment/storage inside the building (low value, low criticality).
 - PV system fastened to Standing Seam Roof (FM-approved – SSR)
 - PV system with steeper slope (anchor type / wind deflector)
 - Wind design based on a « boundary layer Wind Tunnel (BLWT) for each specific installation
 - Hail design
 - Snow loading / drainage
 - Earthquake design
 - Allowing an air gap between the panel and the roof



Air Gap provided (acceptable)



No air gap (not acceptable)

- Safe separating distance (arrays) between groups of solar panels is provided:

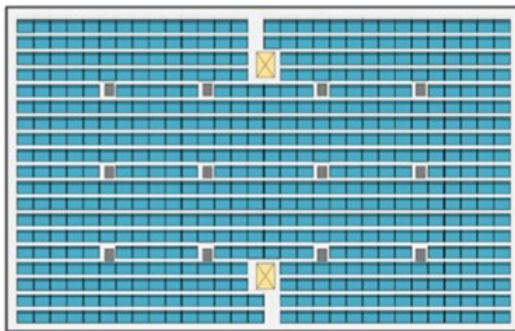

Undesirable arrangement

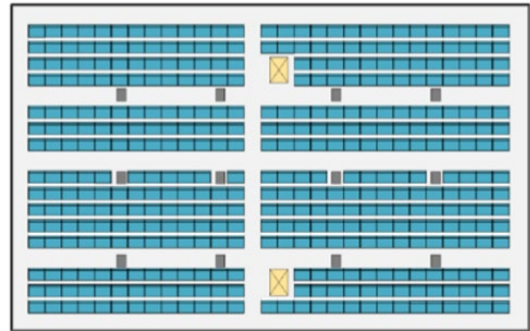

Preferred arrangement

Source: Google image labeled for reuse

- Adequate electric safety is provided such as (but not limited to):
 - DC disconnector downstream of combined box (remotely operated)
 - Residual current DC monitoring
 - Ground Fault Protection Device – GFPD and interlock to trip DC feed to inverter
 - Surge protection on DC and AC side
 - Arc fault protection on all DC circuits over 80V

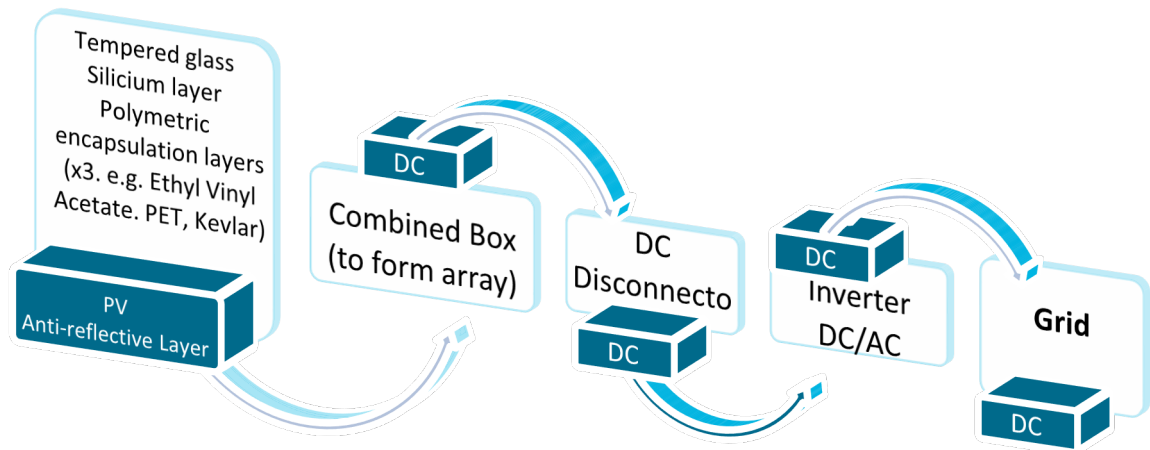

- Adequate Maintenance & Inspection program is provided such as (but not limited to):
 - After-storm survey

Client Guidance Note – Risk Control Practice

- PV array insulation resistance test every 3 years
- Annual IR scan (inverter, wire connection & modules)
- Annual inverter test
- Risk Based Inspection (RBI) for specific locations



- Pre-fire-fighting plan is prepared with local public fire fighters including:
 - List of access routes
 - Location of boxes, inverters and related fuses and disconnectors
 - Fire-fighting equipment
 - Training, drills
 - Fire-fighting plan
 - Review, update document planning
 - Ownership, Leadership established
- Roof-Mounted Solar PV is NOT acceptable when:
 - Building integrated photovoltaic (BIPV) installations



Black solar roof tiles. Building-integrated photovoltaic systems consisting of modern monocrystal black solar roof tiles

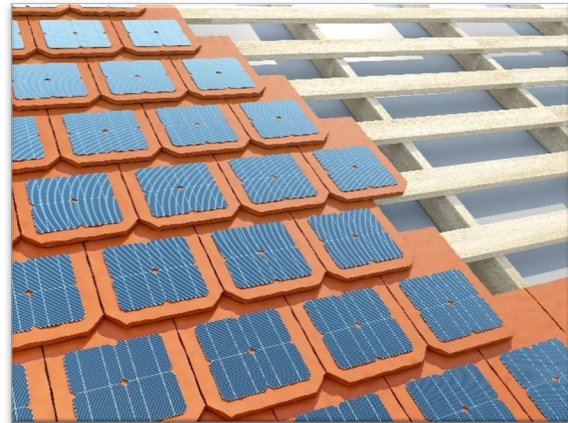
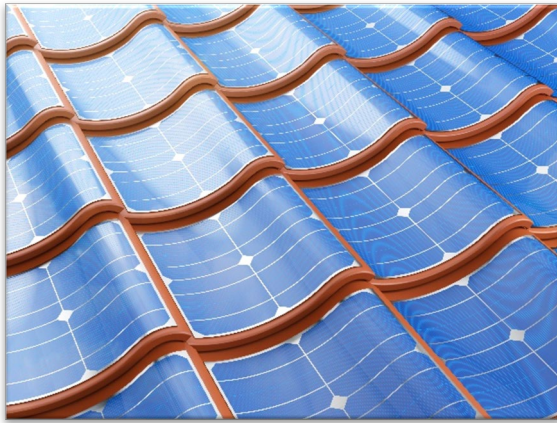

- PV panels installed on combustible insulated roofs (polyurethane, polystyrene, polyisocyanurate...)
- PV panels installed on light roofs (metallic panels with or without insulation)
- A significant combustible load inside the building (storage...)
- Heavy equipment required for the process
- Potential for radioactive release from inside the building (i.e., waste-handling nuclear facilities / nuclear power plant)

2. PSE - LOSS EXPERIENCES

Roof mounted Solar panels – Electric Fire / Fire:

- **The “I. Cy”:** History of events within a household products company:

In 2005, this company launched an initiative named “I. Cy” Goes Renewable (IGR) aimed at using only renewable energy. Roof-top PV panels were identified as one of the possible ways of meeting this goal. Almost 200 PV roof top plants have started operating in North America, Europe and Asia-Pacific. The largest plant has a production capacity of 5.5 MWp.

From 2010-2017, 15 fire incidents occurred. It is to be noted that 8 incidents were related to one PV supplier in one country (probable issue with the installation of the PV panels on the roof – reliability issue). 2 fires were considered as significant while most of the others were very limited. One of the main reasons is the limited combustibility of the roof assembly (PIR thermal roof insulation, approved as FM class 1 assembly).

- **2016:** flames damaged the roof of a commercial building (USA):

It appears that the fire started on Friday, May 27, about 5:30 p.m., when eight to 10 solar panels caught fire at one Distribution Center Drive. There had been thunderstorms four days before. The fire extinguished itself at some point and the damage was only discovered on Tuesday, May 31. The blaze burned the roof’s rubber membrane and created a hole. That roof has more than 6,000 solar panels.

- **2013:** a fire occurred at a Factory, NJ (USA):

The large, refrigerated warehouse (approx. 28 000 m² or 300 000 sq ft) had over 7,000 solar modules covering the rooftops. It was said that the unprotected combustible roofing allowed the fire to spread providing a significant fuel source. Apparently, the PV systems inhibited the fire fighters’ ability to extinguish the fire and it took more than 24 hours to bring it under control. The entire building and its contents were completely destroyed during this incident.

- **2013: a fire occurred at a corporate headquarters, Wisconsin (USA):**

The wood frame, recycled cotton/denim insulation and the PV system all contributed to the development of the fire.

The fire started inside the building and spread to a concealed attic space. The building was protected by a wet-pipe sprinkler system and the attic was protected by a dry-pipe system. The fire was able to spread through concealed spaces in the building and the sprinkler system was not effective at extinguishing the fire.

When the roof truss partially collapsed, this caused a fracture in the sprinkler pipe system resulting in a significant loss of water pressure.

116 firefighters and 31 engines responded, and it took 18 hours to bring the fire under control.

In this specific case, the entire roof became energized because of the combination of the fire, the PV system, and the metal roof. This limited the ability of the fire department to prevent the spread of the fire to other parts of the building.

- **2013: a fire occurred in large Christmas goods warehouse, New Jersey (USA):**

This large Christmas goods warehouse (approx. 65 000 m² or 700 000 sq ft) had over 8,000 solar modules on the roof. An early notification from an eyewitness allowed for a rapid response. Over 300 panels were involved in the fire, but the fire never entered the building.

- **2012: a fire occurred in a warehouse, Germany:**

A 4 000 m² (43 000 sq ft) area was involved. According to the local fire department, the cause of the fire was a technical defect in the photovoltaic system.

- **2011: a fire occurred in North Carolina on the roof of a drywall manufacturing company:**

Similar to the retail store (below) fire in California, the cause of the fire was reportedly ground-fault-related.

- **2009: a fire occurred in California on the membrane roof of a retail store:**

The store had a 383-kW array on the roof which contained 1826 solar PV modules arranged in 166 strings with 11 modules each. The fire reportedly started in two locations due to causes associated with a ground fault.

Surface mounted Solar panels - Wind Exposure:

The big surfaces of solar modules (250 m²) behave as sails.

The mechanical effort is transmitted to structures and tracking electrical engines: the torque transmitted to the gear teeth is huge (Crown / pinion gear relationship of 124:12).



© SCOR Claims Marc Godfrey

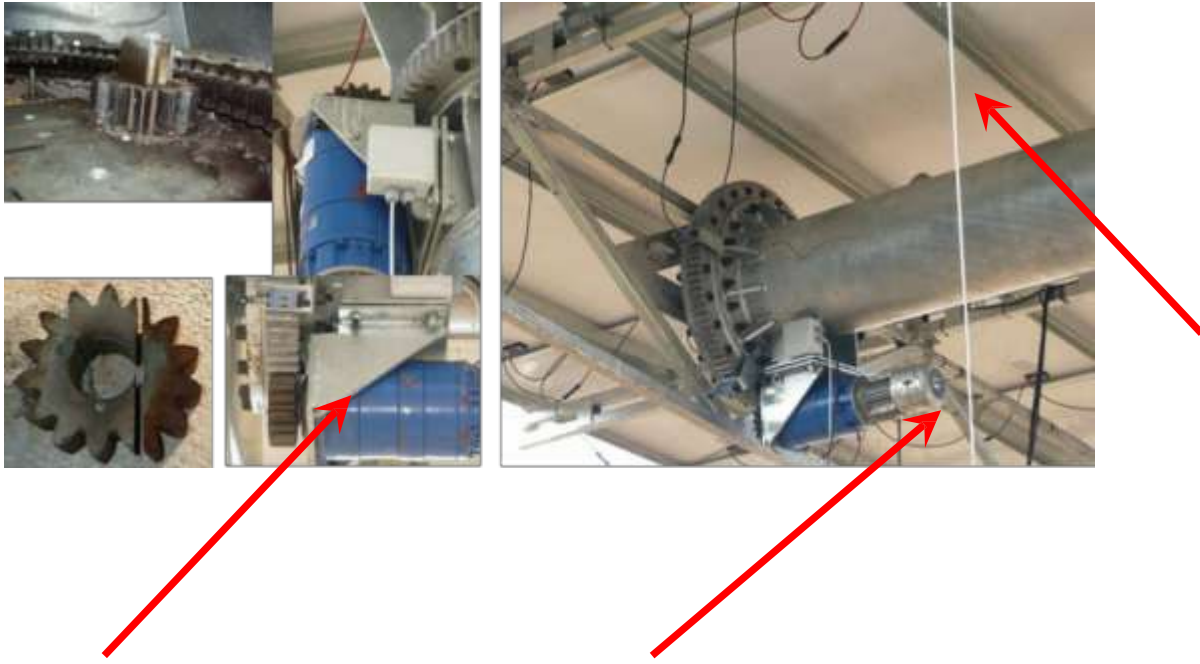

Solutions:

Fasten panels with long frames in upper and lower side of each row of panels.



Arrange the panel rows in separate/different levels to allow an air flow and decrease the “sail effect”.



Client Guidance Note – Risk Control Practice

A Brake system in the disk brakes or hydraulic brake helps to support the wind torque:



Metallic pieces must ensure the fastening of panels to structures to avoid “flying panels”:

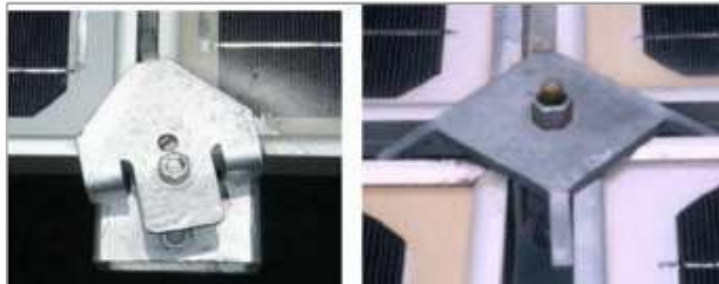

Faulty design:

Foundations: a faulty design necessitates the entire rebuilding of all the foundations of a Solar Farm: Loss of 1 400 000 €



Faulty design of metallic rings fastening panels to main structure: Loss of 400 000 € (replacement of 187 200 screws)



Winds of 80 Km/h caused the break of 10 tracking electrical engines leaving the tracker in free movement subsequently causing the panel structure to fall:

Loss of 100 000 €:



© SCOR Claims Marc Godfrey

Solar Ranch in California – Tornado F0:

April 2015 - USA - Tornado Damage to Solar panels. Heavy damages on modules and structure (#\$51Mio PD and 6-7 months BI -repair period).

Substations:

Major losses arising from damages to substations are very frequent severely affecting BI or CBI cover due to the inability of the plant to deliver electricity to the T&D grid.

3. PSE – LOSS ESTIMATES

Definitions:

Maximum Possible Loss (MPL): The MPL – Maximum Possible Loss – is the estimate in monetary terms of the largest loss which can be expected as a consequence of an insured event. It corresponds to the worst-case scenario after due consideration of all possible events or combination of events, in particular:

- Fire: all fire protection systems are inoperable, manual fire-fighting efforts are ineffective and fire can only be stopped by an impassable obstacle or by the lack of continuity of combustible materials.
- All Other Losses: all possible scenarios must be considered in addition to fire and explosion, in particular, natural perils (earthquakes, storms, floods), civil commotion and man-made catastrophes.
- For the explosion scenario in petrochemical-related industries, a software program is used to determine the damage following a Vapor Cloud Explosion.

The MPL calculation includes PD, BI and interdependencies between sister plants where relevant. Neighboring exposure and CBI should be notified within the scenario where relevant. See § Accumulation.

Normal Loss Expectancy (NLE): SCOR's NLE is the consequence of an accident, which occurs when all the loss-limiting systems provided to minimize the consequences of that accident, function to achieve the results intended. An assessment should be based on a single fire event unless another greater relevant exposure exists.

See the MPL Handbook for details on terminology, scenario, and methods.

Scenarios (Roof-Mounted):

Maximum Possible Loss (MPL):

- Total loss of PV systems and of the building (aggravating factor) except when the roof is made of reinforced concrete (combustible load limited to the outside membrane) (*) and there is no combustible continuity (i.e., cables) that could lead to the ignition of the building and its contents (e.g., along walls). This would ultimately result in PD and BI.

(*) other non-combustible roof / FM-approved roof will not contribute fuel to the fire. However, these roofs won't be able to sustain the heat and radiation for too long, losing their integrity (leading to potential collapse allowing the fire to develop inside the building).

Normal Loss Expectancy (NLE):

- Same as above since fire fighters may be reluctant to fight a fire in a building involving potentially energized PVs (i.e., aggravating factor again).

Scenarios (Ground-Mounted):

Maximum Possible Loss (MPL):

- Total loss of PV systems in one or more farms due to hail impact, windstorm, tropical storm, wildland fire / bushfire (* see note below) or earthquake resulting in PD and BI.

Normal Loss Expectancy (NLE):

- Lighting strike damaging electronic equipment resulting in BI for replacement.
- Total loss of the substation due to fire resulting in at least 4 months BI (or more) in the case of specially designed electrical equipment.
- Total loss of the power transformer resulting in a relatively long BI depending on replacement time and availability of transformer.
- All the above events resulting in BI and potential CBI accumulation.

(*) Note on Wildland Fire/Bushfire Exposure: Wildland Fire Exposures (assessment as per FM Global Data Sheet 9.19 Wildland Fire/Bushfire Exposure):

- As per local maps showing the zones that are exposed to wildland fire
- As per history when available
- If there are no local maps use the following distances as a guide to judge whether there is an exposure:
 - Within 800 m (0.5 miles) of any forest
 - Within 30 m (100 ft) of grasslands
- There are three ways a wildland fire can damage a building:
 - Flying embers blown by the wind can land on and ignite combustible external elements of the solar farm construction. This is the most common ignition source.
 - Fire can spread right up to the tower of the solar farm so there is direct flame impingement.
 - The heat radiated from the height of the flames can raise the temperature of the exposed solar farm components causing them to reach their auto-ignition point.
- Topography: a site (wind farm) built on a slope is more exposed to wildfire
- Combustibility of solar farm components is a key factor
- Adequate clearance zone for solar farms required as follows:
 - minimum of 30 m (100 ft) from grassland (trees up to 2m high) exposure,
 - and 100 m (330 ft) from shrubland (trees up to 8m high), woodland (trees up to 30m high), or forest exposure (trees 30-50m high).

Accumulation:

- The above MPL and NLE scenarios may apply to different insureds located in the same area resulting in BI and potential CBI accumulation. (A clear definition of ‘Client’ is required: the client must be identified as the owner of the substation to which the insured sells the electricity – a true bottleneck). This potential accumulation and Contingent Business Interruption (CBI) must be taken into account for underwriting purposes (“one risk definition” – please refer to the client guidance note Loss Estimate – MPL Handbook).

4. PSE - UW CONSIDERATIONS

4.1. Warning

Renewable energies are still under development and new risks, including new special hazards and exposure, may arise in the near future resulting in a deviation from the current occupancy guidelines.

4.2. UW Risk Assessment – Engineering – Photovoltaic Solar Energy

Definition (Risk perimeter i.e., solar farm including other critical facilities, groups of solar farms, etc.):

“one risk” as defined as per the policy. This may include (but is not limited to):

- Solar panel parks including inverters and high voltage three-phase step-up transformers.
- Several solar panel parks may be part of “one risk” having different sites (but same insured).
- The above parks may be connected to the same substation (via UG/AG/overhead cables) which can be part of the risk or not (third party. e.g., national grid / private operator)
- including (or not) a connection to the grid (transmission line)

Exposure / Special Hazards / Loss Estimates:

- Exposure, Special Hazards: see section 3.1- WE - Risk Control Topics
- MPL: see section 3.3- WE - Loss Estimates

UW Methodology (Risk analysis process):

- Age, life duration: average lifespan of a solar panel is 25 years depending on the quality of the manufacturer. It could be greater or smaller
- Damages to structures, foundations due to:
 - Land slide,
 - Material or workmanship faulty design.
- Theft
- Vandalism.
- Fire risk
- Testing and commissioning
- NatCat (earthquake, wind, flood, hail, ...)
- ALOP

IV - THERMAL SOLAR ENERGY (TSE)

This section is limited to "large scale thermal solar energy production systems" excluding "residential/local use".

1. TSE - RISK CONTROL TOPICS

Occupancy:

Thermal solar energy (TSE) is a form of energy and a technology for harnessing solar energy to generate thermal energy or electrical energy for use in industry and in the residential and commercial sectors. High-temperature collectors concentrate sunlight using mirrors or lenses and are generally used for fulfilling heat requirements up to 300 deg. C / 20 bar pressure in industries and for electric power production. However, there is a term that is used for both applications: Concentrated Solar Thermal (CST) for fulfilling heat requirements in industries and Concentrated Solar Power (CSP) when the heat collected is used for power generation (sometimes called solar thermoelectricity). There are basically two main high-temperature collectors (Solar Power Tower and Parabolic Trough) as follows:

Solar Power Tower design: A solar power tower consists of an array of dual-axis tracking reflectors (heliostats) that concentrate sunlight on a central receiver atop a tower. The receiver contains a fluid deposit which can consist of sea water or molten salt. The working fluid in the receiver is heated to 500–1000 °C (773–1,273 K (932–1,832 °F)) and then used as a heat source for a power generation or energy storage system.



Electrical power is produced when the concentrated light is converted to heat which can either drive a heat engine (usually a steam turbine) connected to an electrical power generator or power a thermochemical reaction.

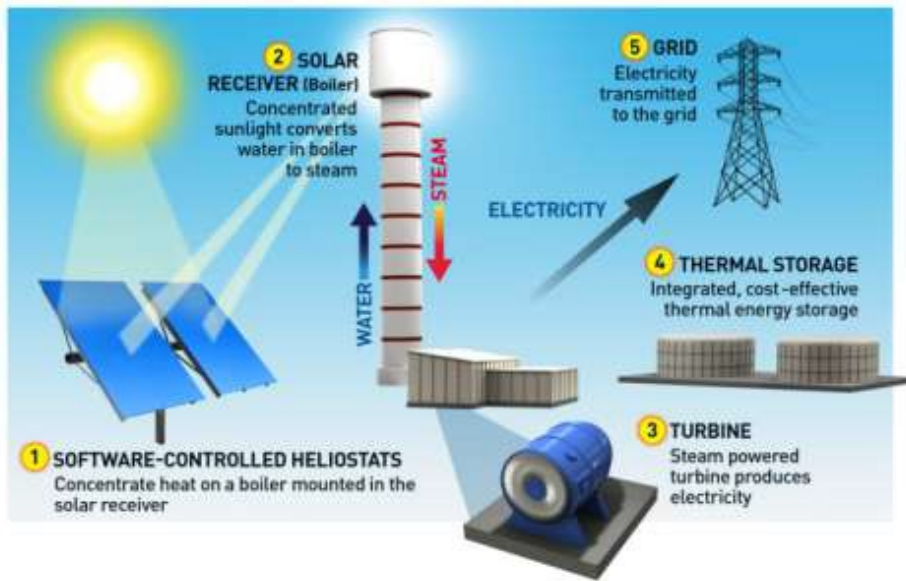

Parabolic Trough design: use a curved, mirrored trough which reflects the direct solar radiation onto a glass tube containing a fluid (also called a receiver, absorber or collector) running the length of the trough, positioned at the focal point of the reflectors. A fluid (also called Heat Transfer Fluid) passes through the receiver and becomes very hot. Common fluids are synthetic oil, molten salt and pressurized steam. The fluid containing the heat is transported to a heat engine where about a third of the heat is converted to electricity.

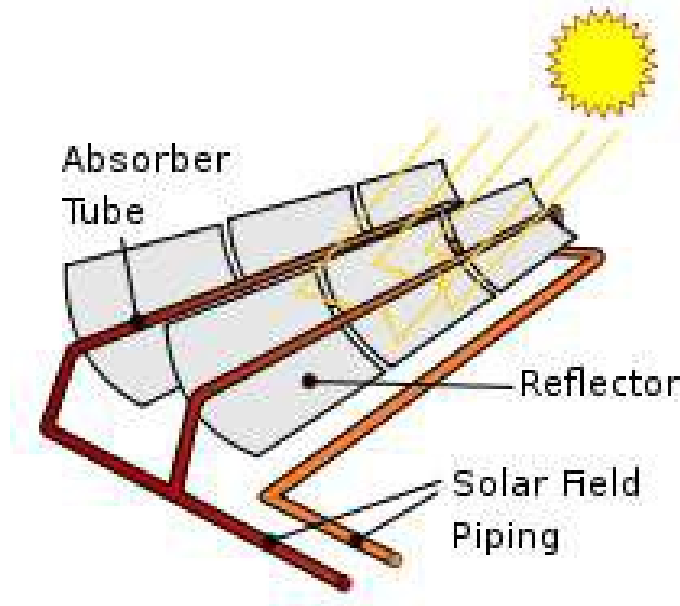

Source: Google image labeled for reuse

Exposures:

Natural Perils:

- Hail impact on solar panels (“Solar Field”)
- Snow, Rain, and Ice (“Solar Field”)
- Wind on solar panels (“Solar Field”)
- Sand and dust storms (“Solar Field”)
- Lightning for all equipment (all facilities)
- Earthquake (all facilities)
- Tsunami in coastal area (all facilities)
- Flood (all facilities)

Wildfire / Bush fire (all facilities)

Theft: copper cabling theft may affect several units.

There could be Contingent Business Interruption and potential accumulation when various clients of thermal solar farm(s) are impacted when these farms cease operating.

Special hazards:

Fire:

- Fire involving combustible Heat Transfer Fluid (HTF): The HTF system may operate at temperatures above the flash point (Fp) of the HTF (e.g., Therminoil VP-1 Fp: 110°C used in a system operating at 390°C). These systems have the potential for great destruction, as they involve the pumping of hot flammable liquids (i.e., combustible liquid heated above Fp) in conjunction with one or more unfavorable factors, such as systems that often have large holdups and high flow rates, or where piping and user equipment is located throughout the facility or is adjacent to other important equipment.
- Molten salts (used as a receiver fluid deposit for “Solar Power Tower design” or as Thermal Energy Storage – ETS for the “Parabolic Trough design”):
 - Thermal tube welding failure (critical point: thermal fluid leak)
 - Thermal fluid leak: pollution and liability (cleaning cost).
 - Thermal fluid:
 - Risk of breakage if it exceeds 400°C
 - Risk of freezing if it falls below 12°C
 - Highly flammable (containing alcohol)
- Thermal Energy Storage (TES) systems including molten salt tanks used as thermal storage and integrated into the conventional HTF of the Parabolic Trough design through a series of heat exchangers: the thermal energy storage system is charged by taking hot HTF from the solar field and running it through the storage heat exchangers. Simultaneously, cold molten-salt is taken from the cold storage tank and run “counter-current” through the heat exchangers. It is heated and stored in the hot storage tank for later use. Molten salt stored in the cold salt tank is heated during the day by a side stream of solar heated HTF not used for steam generation. This heated salt is then stored in the hot salt tank until early evening.
- Fire involving hydraulic / lubrication oil on steam turbine (“Power Block”)
- Fire in electrical room
- Fire involving oil-filled transformer

Loss of power for process controlling equipment

Machinery Breakdown:

- Disintegration of Steam Turbine (“Power Block”) and fire following impacted adjacent STGs. Note that the Power block is the part of the Plant where the water steam cycle components, thermal energy storage system and electrical connection are located. The power block encompasses the following major components of the water-steam cycle:
 - Solar heat exchanger. The solar heat exchanger is the equipment required to generate the steam from the energy delivered by the Heat Transfer Fluid. The heat exchange occurs in boilers usually arranged in tandem in 3 stages – economizer (preheater), evaporator, and superheater – with several modules per stage. The economizer provides preheat, and the initial conversion to steam occurs in the evaporator. Superheating occurs in the third stage. The evaporators are connected in parallel and horizontally installed.
 - Steam turbine Generator: The steam turbine and generator set is the element in charge of extracting the thermal energy from the steam obtained in the cycle and converting it into electricity to be delivered to the grid.

Settlement:

- Ground settlement

Human Factor

Supervision of Property

Loss Prevention Recommendations:

Natural Perils:

- Ensure mirrors or lenses (“Solar Field”) are designed to withstand hail impact without damages.
- Ensure mirrors or lenses are designed to withstand local extreme wind conditions without damages.
- Lightning: ensure adequate grounding & bonding of equipment and install lightning arrestors and surge protectors designed to protect electronic equipment by absorbing electrical surges.
- Earthquake: Design and construct all buildings and structures, equipment anchorage, support frames and foundations, tanks, piping-system bracing and non-structural elements to resist maximum local expected earthquake forces.
- Flood: TSE facilities should not be located in a flood zone. Studies prior to installation should be conducted and well documented.
- Tsunami in coastal areas: TSE facilities should not be located in a tsunami exposed area. Studies prior to installation should be conducted and well documented.

Wildfire / Bushfire:

- Provide adequate space separation and protection from wildland fires and bushfires in accordance with Data Sheet 9-19, Wildland Fire/Bushfire Exposure, and from combustible yard storage or inadequately protected adjacent buildings in accordance with Data Sheet 1-20, Protection Against Exterior Fire Exposure (see note on section IV.3 Loss Estimates)

Fire:

- Fire protection of steam turbine (section XI)
- Fire protection of electrical equipment (electrical room, substation, panels, transformers) in accordance with section VIII.
- Fire protection of oil-filled transformer (section XI)

Loss of Power for process controlling equipment:

- Provide an emergency source of uninterruptible power for the system controlling the mirrors (dual-axis tracking reflectors - heliostats) if the loss of the control system could be dangerous. Alternatively, provide a fail-safe system that will position the mirrors in a safe position upon loss of power. Provide an alternate means of power for the mirrors' control system if it is critical to maneuver the mirrors into a safe position during a windstorm or hailstorm.

Settlement:

- Ensure there are proper foundations for Solar Power Towers.

Human Factor:

- *Emergency Response and Pre-Incident Planning:* Design and institute an emergency response plan (as per NFPA or FM Global Data Sheet). Include potential fire scenarios in the emergency response plan.
- *Pre-Incident Planning with the Public Fire Service:* Due to the remote location of solar power facilities, the fire-fighting response may be delayed. Therefore, pre-incident planning with the fire service is critical. Arrange and prepare documented procedures to expedite access and the emergency response to events such as fire. Prepare schematics to guide responders and indicate the location of access routes throughout the facility. Train and authorize designated personnel to serve as liaisons with the public fire service. Provide the local fire service with sufficient knowledge of fire hazards and response procedures to aid them in conducting fire-fighting operations. Document this information in the pre-incident plan with the local fire service.
- *Hot Work:* Establish a hot work permit and supervision program.

Supervision of Property:

- Provide protection against potential theft or vandalism. This could include, but is not limited to, any of the following: the use of security fencing, exterior lighting, continuous employee attendance and the security service.
- The level of protection needed will vary depending on the value of the facility.

BI/CBI

Develop a Contingency Plan and Business Continuity Plan in case of a major loss in order to mitigate BI and CBI exposure (e.g., loss of a third party operated substation, loss of connection to the grid or loss of power supply for the initial starting sequence of machinery and equipment prior to the initial start and/or after the shut-down / maintenance period and/or for controlling machinery and equipment depending on design).

2. TSE - LOSS EXPERIENCES

Most frequent losses are caused by the breakdown of steam turbines followed by damages to reflectors by wind or hail.

Substations:

Major losses arising from damages to substations are very frequent, severely impacting the BI or CBI cover due to the inability of the plant to deliver electricity to the T&D grid.

3. TSE - LOSS ESTIMATES

Definitions:

Maximum Possible Loss (MPL): The MPL – Maximum Possible Loss – is the estimate in monetary terms of the largest loss which can be expected as a consequence of an insured event. It corresponds to the worst-case scenario after due consideration of all possible events or combination of events, in particular:

- Fire: all fire protection systems are inoperable, manual fire-fighting efforts are ineffective and fire can only be stopped by an impassable obstacle or by the lack of continuity of combustible materials.
- All Other Losses: all possible scenarios must be considered in addition to fire and explosion, in particular, natural perils (earthquakes, storms, floods), civil commotion and man-made catastrophes.
- For the explosion scenario in petrochemical-related industries, a software program is used to determine the damage following a Vapor Cloud Explosion.

The MPL calculation includes PD, BI and interdependencies between sister plants where relevant. Neighboring exposure and CBI should be notified within the scenario where relevant. See § Accumulation.

Normal Loss Expectancy (NLE): SCOR's NLE is the consequence of an accident, which occurs when all the loss-limiting systems provided to minimize the consequences of that accident, function to achieve the results intended. An assessment should be based on a single fire event unless another greater relevant exposure exists.

See the MPL Handbook for details on terminology, scenario and methods.

Scenarios:

Maximum Possible Loss (MPL):

- Total loss of mirrors or lenses in one or more farms due to hail impact, windstorm, tropical storm, wildland fire / bushfire (* see note below) or earthquake resulting in PD and BI. Full reinstatement of the so-called “solar field” may take longer than expected due to manpower issues given the wide surface of mirror lenses to be repaired / replaced. (At least 18 months anticipated).
- Major fire involving the HTF system (i.e., pump house and/or heat exchanger) that can represent up to 10% of the PD sum insured. (At least 12-15 months BI anticipated).
- Total loss of one or more Steam Turbine Generators – so-called “Power Block” - when installed in the same area / building without an adequate separating distance / segregation, due to disintegration (e.g., machinery failure scenario) and fire following or major fire involving the lube oil system. (At least 18 months BI anticipated).

Normal Loss Expectancy (NLE):

- Lighting strike damaging electronic equipment resulting in BI for replacement.
- Total loss of steam turbine generator resulting in a relatively long BI (at least 18 months).
- Total loss of the substation due to fire, resulting in at least 4 months BI (or more) in the case of specially designed electrical equipment.
- Total loss of the power transformer resulting in a relatively long BI depending on replacement time and availability of transformer.
- All the above events resulting in BI and potential CBI accumulation.

(*) Note on Wildland Fire/Bushfire Exposure: Wildland Fire Exposures (assessment as per FM Global Data Sheet 9.19 Wildland Fire/Bushfire Exposure):

- As per local maps showing the zones that are exposed to wildland fire
- As per history when available

Client Guidance Note – Risk Control Practice

- If there are no local maps use the following distances as a guide to judge whether there is an exposure:
 - Within 800 m (0.5 miles) of any forest
 - Within 30 m (100 ft) of grasslands
- There are three ways a wildland fire can damage a building:
 - Flying embers blown by the wind can land on and ignite combustible external elements of the solar farm construction. This is the most common ignition source.
 - Fire can spread right up to the tower of the solar farm so there is direct flame impingement.
 - The heat radiated from the height of the flames can raise the temperature of the exposed solar farm components causing them to reach their auto-ignition point.
- Topography: a site (wind farm) built on a slope is more exposed to wildfire
- Combustibility of solar farm components is a key factor
- Adequate clearance zone for solar farms required as follows:
 - Minimum of 30 m (100 ft) from grassland (trees up to 2m high) exposure,
 - And 100 m (330 ft) from shrubland (trees up to 8m high), woodland (trees up to 30m high) or forest exposure (trees 30-50m high).

Accumulation:

- The MPLs and NLEs scenarios above may apply to different insureds located in the same area resulting in BI and potential CBI accumulation (clear definition of Client is required: it must be identified as the owner of the substation to which the insured sell the electricity – it is a bottleneck). These Potential Accumulation and Contingent Business Interruption – CBI- are to be taken into account for underwriting purpose (“one risk definition” – please refer to the client guidance note Loss Estimate –MPL- Handbook).

4. TSE - UW CONSIDERATIONS

4.1. Warning

Renewable energies are still under development and new risks, including new special hazards and exposure, may arise in the near future resulting in a deviation from the current occupancy guidelines.

4.2. UW Risk Assessment – Engineering – Thermal Solar Energy

Definition (Risk perimeter i.e., solar farm including other critical facilities, groups of solar farms, etc.):

“one risk” as defined as per the policy. This may include (but is not limited to):

- For **Solar Power Tower design**: an array of dual-axis tracking reflectors (heliostats) that concentrate sunlight on a central receiver atop a tower. The receiver contains a fluid deposit which is heated and then used as a heat source for a power generation or energy storage system.
- **or**
- For **Parabolic trough designs**: a curved, mirrored trough which reflects the direct solar radiation onto a glass tube containing a fluid passing through the receiver containing the heat which is transported to a heat engine to be converted into electricity.
- Several solar panel farms can be part of “one risk” having different sites (but same insured).
- The two designs above may be connected to a substation (via UG/AG/overhead cables) which can be part of the risk or not (third party, e.g., national grid / private operator)
- including (or not) a connection to the grid (transmission line).

Exposure / Special Hazards / Loss Estimates:

- Exposure, Special Hazards: see section V.1- WE - Risk Control Topics
- MPL: see section V.3- WE - Loss Estimates

UW Methodology (Risk analysis process):

- Damages to structures or foundations due to:
 - Land slide,
 - Faulty material, workmanship or design.
- Theft
- Vandalism
- Fire risk
- Testing and commissioning
- NatCat (earthquake, wind, flood, hail, ...)
- ALOP
- Incorrect welding of pipes (critical: lack of heat transfer fluid)
- Steam Turbine: machinery breakdown during testing and commissioning.

4.3. UW Risk Assessment – Property – Thermal Solar Energy

Definition (Risk perimeter i.e., solar farm including other critical facilities, groups of solar farms, etc.):

“one risk” as defined as per the policy. This may include (but is not limited to):

- For **Solar Power Tower design**: an array of dual-axis tracking reflectors (heliostats) that concentrate sunlight on a central receiver atop a tower. The receiver contains a fluid deposit which is heated and then used as a heat source for a power generation or energy storage system.
- **or**
- For **Parabolic trough designs**: a curved, mirrored trough which reflects the direct solar radiation onto a glass tube containing a fluid passing through the receiver containing the heat which is transported to a heat engine to be converted into electricity
- Several solar panel farms can be part of “one risk” having different sites (but the same insured).
- The two designs above may be connected to a substation (via UG/AG/overhead cables) which can be part of the risk or not (third party, e.g. national grid / private operator)
- including (or not) a connection to the grid (transmission line)

Exposure / Special Hazards / Loss Estimates:

- Exposure, Special Hazards: see section 4.1- WE - Risk Control Topics
- MPL: see section 4.3- WE - Loss Estimates

UW Methodology (Risk analysis process):

- Damages to structures or foundations due to land slide
- Theft (due to high value of copper wire)
- Vandalism.
- Fire risk (protection measures in electric items such as inverter boxes, transformers and substations)
- NatCat (earthquake, wind, flood, hail, ...)
- BI / CBI.
- Incorrect welding of pipes (critical: lack of heat transfer fluid)
- Pollution caused by lack of heat transfer fluid
- Heat transfer fluid: highly flammable (containing alcohol) so risk of pipe break if temperature reached is greater than 400° C or less than 12° C.
- Steam Turbine: machinery breakdown due to frequent starts & stops.

V - MATURE TECHNOLOGY (PROVEN)

The following renewable energy risks involve well known technologies and several installed facilities have been operating for years:

1. GEOTHERMAL ENERGY (GE)

This form of energy has been used by humans for over 10,000 years. The Romans used heat from the Earth in their spas and it is still effectively being used in this way in countries such as Iceland. The heat in question comes from Earth's core and is residual energy from Earth's formation. The Earth's crust is too thick in most places to get to a depth where the temperature is high enough. As a result, the best locations are those where the tectonic plates of the Earth's crust meet and in these seismic regions the energy is much closer (sometimes right at) the surface, making it much more accessible.

The way in which geothermal energy (also known as “ground energy” in China) is classified is through temperature, the state of the water and the type of energy usage. Temperature is either low (10 to 100°C) or high (above 100°C). The state of the water is either liquid or steam. The energy usage can be a ground source heat pump, a direct source or commercial electricity generation

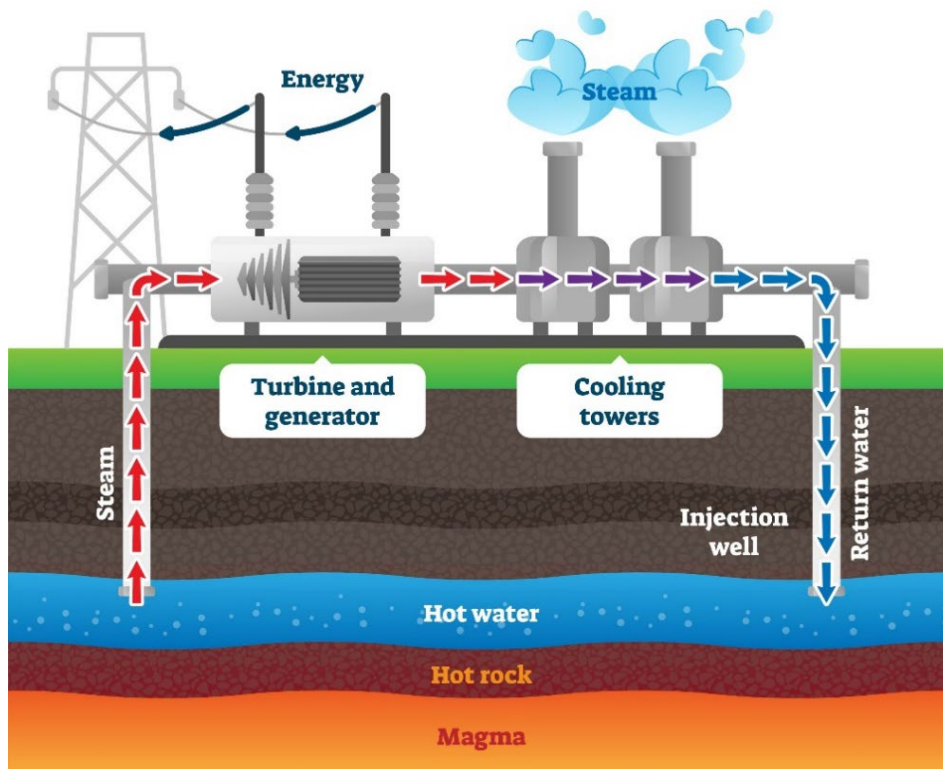

Geothermal power plants use steam produced from reservoirs of hot water found 3 kms or more below the Earth's surface. There are three types of geothermal power plants: *dry steam*, *flash steam* and *binary cycle*.

Dry steam power plants draw from underground resources of steam. The steam is piped directly from underground wells to the power plant where it is directed into a turbine/generator unit. There are only two known underground resources of steam in the United States: The Geysers in northern California and Yellowstone National Park in Wyoming, where the well-known geyser named Old Faithful can be found. Since Yellowstone is protected from development, the only dry steam plants in the country are at The Geysers.

Flash steam power plants are the most common. They use geothermal reservoirs of water with temperatures greater than 182°C (360°F). This very hot water flows up through wells in the ground under its own pressure. As it flows upward, the pressure decreases and some of the hot water boils into steam. The steam is then separated from the water and used to power a turbine/generator. Any left-over water and/or condensed steam is injected back into the reservoir, making this a sustainable resource.

Binary cycle power plants operate with water at lower temperatures of about 107°-182°C (225°-360°F). These plants use the heat from the hot water to boil a *working fluid*, usually an organic compound with a low boiling point. The working fluid is vaporized in a *heat exchanger* and used to turn a turbine. The water is then injected back into the ground to be reheated. The water and the working fluid are kept separate during the whole process, so there is little or no air emissions.

Overall, geothermal energy is a very good renewable option if the location is right. It is very reliable as it is online 95% of the time and is a proven technology, having been used in America for the past 40 years. It is also very environmentally friendly with very low emissions and minimal land use (1-8 acres/MW compared to 19 for coal). However, it is a very localized resource and drilling can be very expensive. It also has a poor environmental reputation, and these are the factors that are currently preventing a more wide-scale usage as summarized below:

Main Geothermal Power's Risk to Project Development:

- **Resources Risk:** a major uncertainty in the development of geothermal projects concerns the size and quality of the geothermal fluids that can be extracted from the underground resource.
- **Project Financing Risk:** geothermal power is reportedly less expensive than competing energy technologies. Unfortunately, geothermal power has higher up-front capital costs because of the need to drill wells. These "extra" up-front capital costs reportedly essentially represent the advance purchase of the project's lifetime of "fuel" for electricity production.
- **Operational & Maintenance Risks:** sustainably managed geothermal reservoirs can maintain energy production for decades and even longer (e.g., the Wairakei geothermal project in New Zealand that has been generating power since the late 1950s and the Geysers geothermal field in California, generating power since 1960). Still, over-exploitation may occur, for reasons commonly related to:
 - Insufficient knowledge on the geothermal resource
 - Lack of communication and operational integration of a resource developed by multiple operators
 - Improved cost-effectiveness of larger projects vs. smaller projects (leading to the development of a larger project that can be sustained by the resource or by a poor injection strategy)

SCOR UW's position: to be seen by CFS WW Coordinator.

Iceland is a pioneer in the use of geothermal energy for space heating. Generating electricity with geothermal energy has increased significantly in recent years. Geothermal power facilities currently generate 25% of the country's total electricity production



During the course of the 20th century, Iceland went from what was one of Europe's poorest countries, dependent upon peat and imported coal for its energy, to a country with a high standard of living where practically all stationary energy is derived from renewable resources. In 2011, roughly 84% of primary energy use in Iceland came from indigenous renewable resources. 66% of it was from geothermal.

2. HYDRAULIC ENERGY (HYDROPOWER)

Flowing water creates energy that can be captured and turned into electricity. This is called hydroelectric power or hydropower.

The most common type of hydroelectric power plant uses a dam on a river to store water in a reservoir. Water released from the reservoir flows through a turbine, spinning it, which in turn activates a generator to produce electricity. But hydroelectric power doesn't necessarily require a large dam. Some hydroelectric power plants just use a small canal to channel the river water through a turbine.



Source: Google image labeled for reuse

Another type of hydroelectric power plant - called a pumped storage plant - can even store power. The power is sent from a power grid into the electric generators. The generators then spin the turbines backwards, which causes the turbines to pump water from a river or lower reservoir to an upper reservoir where the power is stored. To use the power, the water is released from the upper reservoir back down into the river or lower reservoir. This spins the turbines forward, activating the generators to produce electricity.

A small or micro-hydroelectric power system can produce enough electricity for a home, farm, or ranch.

SCOR UW's position: to be seen by CFS WW Coordinator.
See the MPL Handbook for details on terminology, scenario and methods.

VI - HYBRID RENEWABLE ENERGY (HRE)

Some existing hybrid systems are summarized below:

1. HRE - PHOTOVOLTAIC THERMAL HYBRID SOLAR COLLECTOR

Photovoltaic thermal hybrid solar collectors, sometimes known as hybrid PV/T systems or PVT, are systems that convert solar radiation into thermal and electrical energy. These systems combine a photovoltaic cell, which converts electromagnetic radiation (photons) into electricity, with a solar thermal collector, which captures the remaining energy and removes waste heat from the PV module.

The capture of both electricity and heat allows these devices to have higher energy and thus be more overall energy-efficient than solar photovoltaic (PV) or solar thermal alone.

2. HRE - HYDRO & WIND

El Hierro Island belongs to the Islas Canarias archipelago which is located in the Atlantic Ocean. The El Hierro Sustainability Plan, approved on the 27th of November 1997, by the Council of the island of El Hierro, posited the idea of making the island a self-sustained location. This plan was at the origin of the Wind-Hydro-Pumped Station system.

The aim was to make the island the first region able to supply itself with electrical energy through fully renewable energy sources. (Cost of the project: 64.7 Mio €.)

The hydro-wind project integrates a wind farm (five wind turbines Enercon E 70 of 2,3 MW), a pumping set and a hydroelectrical plant. The wind farm is able to supply electrical energy directly to the grid, while simultaneously feeding a pumping set which dams water in an elevated deposit as an energetic storage system. When there is no wind, the hydroelectrical plant uses this stored potential energy in order to guarantee electrical supply network stability. At the same time the system also provides the island with drinkable water reserves.

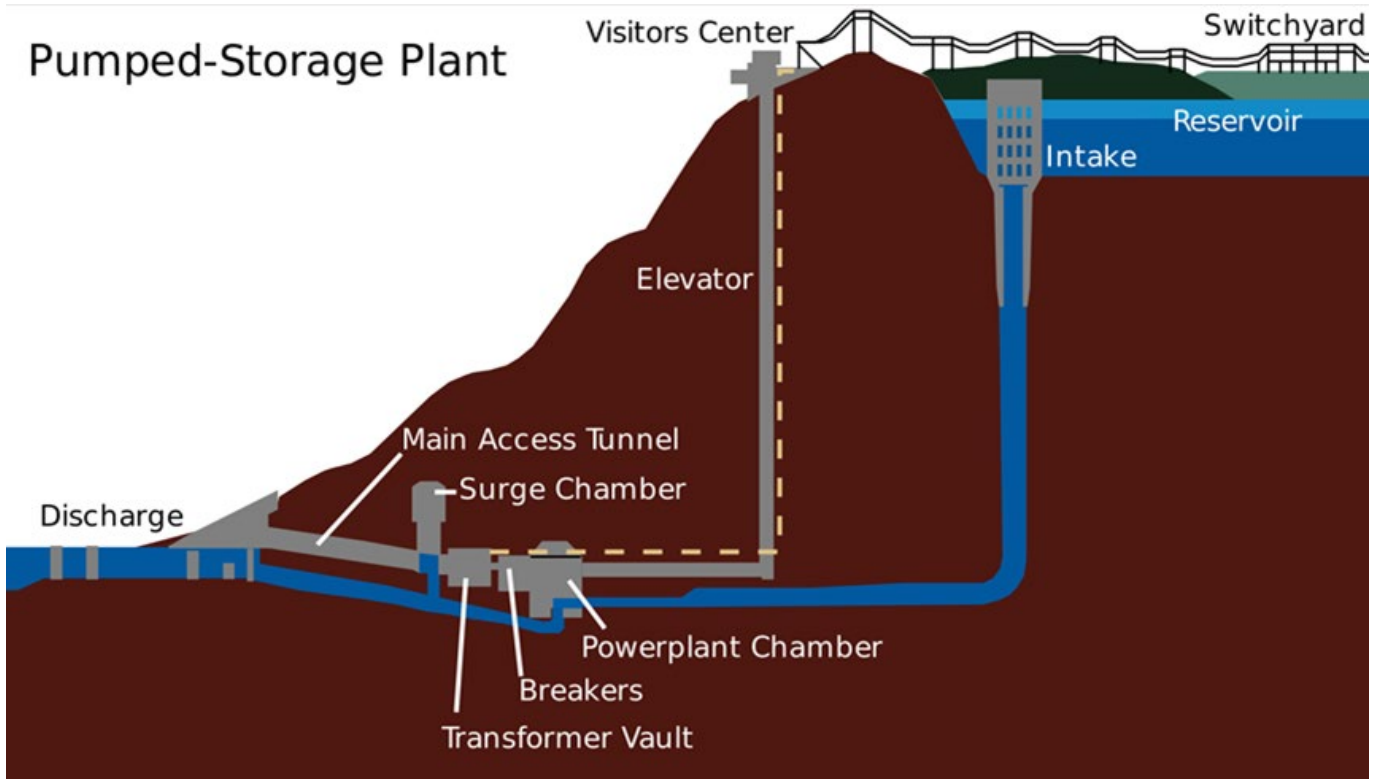

Diagram of the TVA pumped storage facility at Raccoon Mountain Pumped-Storage Plant in Tennessee, USA

Permission details:

This work is in the public domain in the United States because it is a work prepared by an officer or employee of the United States Government as part of that person's official duties under the terms of Title 17, Chapter 1, Section 105 of the US Code. Note: This only applies to original works of the Federal Government and not to the work of any individual U.S. state, territory, commonwealth, county, municipality, or any other

Client Guidance Note – Risk Control Practice

subdivision. This template also does not apply to postage stamp designs published by the United States Postal Service since 1978. (See § 313.6(C)(1) of Compendium of U.S. Copyright Office Practices). It also does not apply to certain US coins; see The US Mint Terms of Use.

It can be treated in much the same way as a standard wind farm risk with special care taken regarding the pressure pipes and water deposits.

SCOR UW's position: to be seen by CFS WW Coordinator.

3. HRE - PHOTOVOLTAIC (PV & WIND)

Another example of a hybrid energy system is a photovoltaic array coupled with a wind turbine. This would create more output from the wind turbine during the winter, whereas during the summer, the solar panels would produce their peak output.

Hybrid energy systems reportedly often yield greater economic and environmental returns than wind, solar, geothermal or trigeneration stand-alone systems by themselves.

VII - OTHER ADVANCED TECHNOLOGIES

The following renewable energy risks include relatively well known / old systems for which the performances and reliability are still not adequate for optimum industrial /commercial purposes and are, thus, being improved.

1. BIOMASS

Biomass is biological material derived from living, or recently living, organisms. It most often refers to plants or plant-based materials which are specifically called lignocellulose biomass. As an energy source, biomass can either:

l) Be used directly via combustion to produce heat and or electricity (generator) as described below:

Warning: *the points below emerge from a study conducted in 2011 on the European market upon the request of those in the Treaty business in Germany. We recently contacted some UWs and risk control engineers who reported that a similar situation remains in 2014 as far as the risk quality and hazards are concerned, as well as for the minimum requirements. These factors should be revised and updated for other territories once accurate data is available.*

Occupancy

Biogas is often used as an open cycle or combined cycle in agricultural-type industries and sometimes in the food industry. The raw material consists of organic waste, wood, effluent treatment residue and mud but also oil from the food industry. The raw material is filled in a digester for fermentation. The gas released is either used as

- fuel for a water boiler in order to produce steam to be used in the heating process or in buildings or residential houses
- fuel for gas-driven engine generators to produce electricity to be sold on to the grid, with the heat that is recovered used in heating processes (e.g., for the nearest slaughterhouse)

Overall quality of such a risk

This type of occupancy is not considered as a typical and standard electric or heat generation process unit. These facilities are usually owned and/or operated by manpower of an agricultural type. Not all the technical issues and hazards are always fully grasped, controlled or managed as in the regular industry.

Special Hazards:

The following hazards leading to losses were reported:

- Pollution: the overflowing of the digester or leaks from the bottom constitute a potential environmental issue.

- Machinery breakdown: the gas-driven engine is usually certified to work with a gas containing at least 90% methane. However, the biogas produced from different organic material usually contains no more than 60% to 70% methane. Moreover, depending on the hydrosulfide content of the gas (H₂S is toxic and corrosive), silicate deposits can accumulate on the internal parts of the engine resulting in problems of lubrication, corrosion and mechanical stress. This results in a potentially high frequency of major mechanical damage to the engine (PD: up to 500 to 600k€ per engine, BI: 3 to 4 months for replacement).
- Machinery breakdown: the gas-driven engines are usually installed by specialized manufacturers (e.g., Austria, Germany) and should be maintained according to the manufacturer's prescriptions. The main reported problem is to find a local contractor certified for maintenance of this type of equipment. This should be indicated in the wording.
- Explosion, Fire: gas leak, accumulation, ignition and explosion potential within the gas-driven engine room or upstream between this room and the gas collector on the digester if in a confined space.
- Implosion of the digester in case of an improper gas balance during the fermentation process or during biogas extraction.

Detection / Protection requirement:

The following minimum safeguards should be provided:

- Gas analysis upstream of the engine (looking for H₂S and other contaminants)
- Gas filters (to be replaced regularly)
- Gas monitoring on-line (monitoring the mixture and methane rate)
- Gas detection inside the gas driven engine room and upstream back to the digester when installed in a confined space. Gas alarm to be connected to a constantly manned location.
- Automatically activated fixed gaseous extinguishing system within the gas-driven engine room. Use of gases that are environmentally friendly and safe for humans is recommended.
- Digester and biogas systems should be equipped with a depressurization safeguard to prevent either explosion or implosion.

Loss History:

the following loss amount and frequency have been reported:

- Considering 12-13 facilities installed: around 2-3 losses per year and usually an average of PD 200-300k€ for each loss (mostly gas-driven engine machinery breakdown) and BI 3-4 months in case of the gas-driven engine needing to be replaced.

II) Or biomass indirectly used after being converted to various forms of biofuel (Biofuel section see below).

2. BIOFUEL

Biofuels are made by a biomass conversion (biomass refers to recently living organisms, most often referring to plants or plant-derived materials). This biomass can be converted to convenient energy-containing substances in three different ways: thermal conversion, chemical conversion and biochemical conversion. This biomass conversion can result in solid, liquid or gas fuel, thus, biofuel.

Liquid fuels for transportation include:

- **Bioethanol:** alcohol made by fermentation, mostly from carbohydrates produced in sugar or starch crops such as corn, sugarcane or sweet sorghum. The fermentation is followed by a distillation process separating the component substances from the liquid mixture by selective vaporization and condensation (a well-known process. Distillation is not a prototype). Cellulosic biomass, derived from non-food sources, such as trees and grass, is also being developed as a feedstock for ethanol production. Ethanol, in its pure form, can be used as a fuel for vehicles but it is usually used as a gasoline additive to increase octane and improve vehicle emissions. Bioethanol is widely used in the USA and in Brazil. Current plant designs do not provide for converting the lignin portion of the plant

raw materials to fuel components by fermentation. Please refer to FM Global Data Sheet 7.74 “Distilleries” for details about the process, hazards and protection requirements.

- **Biodiesel:** can be used as a fuel for vehicles in its pure form but is usually used as a diesel additive to reduce levels of particulates, carbon monoxide and hydrocarbons from diesel-powered vehicles. Biodiesel is produced from oils or fats using transesterification and is the most common biofuel in Europe.
- **Green diesel:** produced through hydrocracking biological oil feedstock, such as vegetable oils and animal fats. Hydrocracking is a refinery method that uses elevated temperatures and pressure, in the presence of a catalyst, to break down larger molecules, such as those found in vegetable oils, into shorter hydrocarbon chains used in diesel engines. It does not require new engines, pipelines or infrastructure to distribute and use, but has not been produced at a cost that can compete with petroleum.
- **Biofuel gasoline:** in 2013, UK researchers developed a genetically modified strain of *Escherichia coli* which could transform glucose into biofuel gasoline that does not need to be blended.
- **Vegetable oil:** filtered waste vegetable oil is generally not used as fuel, but lower- quality oil can and has been used for this purpose. Used vegetable oil is increasingly being processed into biodiesel, or (more rarely) cleaned of water and particulates and used as a fuel. Vegetable oil can also be used in many older diesel engines that do not use common rail or unit injection electronic diesel injection systems.
- **Bioethers:** (also referred to as fuel ethers or oxygenated fuels) are cost-effective compounds that act as octane rating enhancers. Bioethers are produced by the reaction of reactive iso-olefins (such as iso-butylene) with bioethanol. Bioethers are created by wheat or sugar beet. They also enhance engine performance, whilst significantly reducing engine wear and toxic exhaust emissions. Though bioethers are likely to replace petroethers in the UK, it is highly unlikely they will become a fuel in and of itself due to the low energy density.
- **Biogas:** methane produced by the process of anaerobic digestion of organic material by anaerobes. It can be produced either from biodegradable waste materials or by the use of energy crops fed into anaerobic digesters to supplement gas yields. The solid byproduct, digestate, can be used as a biofuel or a fertilizer. Farmers can produce biogas from manure from their cattle by using anaerobic digesters.
- **Syngas:** a mixture of carbon monoxide, hydrogen and other hydrocarbons, is produced by partial combustion of biomass (solid distillation), that is, combustion with an amount of oxygen that is not sufficient to convert the biomass completely to carbon dioxide and water. Before partial combustion, the biomass is dried and sometimes pyrolyzed. The resulting gas mixture, syngas, is more efficient than direct combustion of the original biofuel as more of the energy contained in the fuel is extracted. Syngas may be burned directly in internal combustion engines, turbines or high-temperature fuel cells.
- **Solid biofuels:** include wood, sawdust, grass trimmings, domestic refuse, charcoal, agricultural waste, non-food energy crops and dried manure. When raw biomass is already in a suitable form (such as firewood), it can burn directly in a stove or furnace to provide heat or raise steam. When raw biomass is in an inconvenient form (such as sawdust, wood chips, grass, urban waste wood, agricultural residues), the typical process is to densify the biomass. This process includes grinding the raw biomass to an appropriate particulate size (known as hogfuel), which is then concentrated into a fuel product. The current processes produce wood pellets, cubes or pucks. Industry has used sawdust, bark and chips for fuel for decades, primarily in the pulp and paper industry, and also bagasse (spent sugar cane)- fueled boilers in the sugar cane industry. One of the advantages of biomass fuel is that it is often a byproduct, residue or waste-product of other processes, such as farming, animal husbandry and forestry. A problem with the combustion of raw biomass is that it emits considerable amounts of pollutants such as particulates and polycyclic aromatic hydrocarbons. Even modern pellet boilers generate considerably more pollutants than oil or natural gas boilers. Pellets made from agricultural residues are usually worse than wood pellets, producing much larger emissions of dioxins and chlorophenols.

3. FUEL CELLS

The first fuel cells were invented in 1838. The first commercial use of fuel cells came more than a century later in NASA space programs to generate power for probes, satellites and space capsules. Since then, fuel cells have been used in many other applications. Fuel cells are used for primary and backup power for commercial, industrial and residential buildings and in remote or inaccessible areas. They are also used to power fuel cell vehicles, including forklifts, automobiles, buses, boats, motorcycles and submarines.

Fuel cells come in many varieties; however, they all work in much the same manner (as shown below).

They are made up of three adjacent segments: the anode, the electrolyte and the cathode. Two chemical reactions occur at the interfaces of the three different segments. The net result of the two reactions is that fuel is consumed, water or carbon dioxide is created as well as an electric current which can be used to power electrical devices, normally referred to as the load.

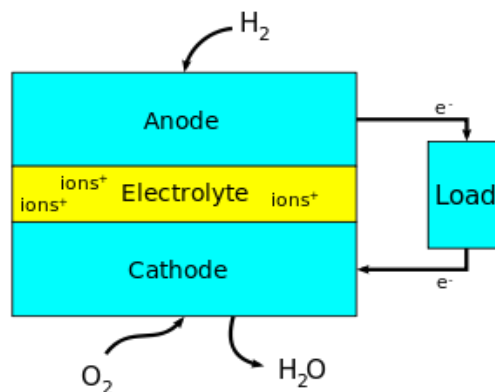

Source: Google image labeled for reuse

Fuel cells are different from batteries in that they require a continuous source of fuel and oxygen/air to sustain the chemical reaction whereas in a battery the chemicals present in the battery react with each other to generate an electromotive force (emf). Fuel cells can produce electricity continuously for as long as these inputs are supplied.

The most common fuel is hydrogen produced from the steam methane reforming of natural gas, but for greater efficiency hydrocarbons can be used directly, such as natural gas and alcohols like methanol.

The electrolyte substance usually defines the type of fuel cell as follows:

- **Proton exchange membrane fuel cells (PEMFCs):** a proton-conducting polymer membrane (the electrolyte) separates the anode from the cathode. Many companies are working on the production of an 80-kW automotive fuel cell system.
- **Phosphoric acid fuel cells (PAFC):** acid is used as a non-conductive electrolyte to pass positive hydrogen ions from the anode to the cathode. These cells commonly work in temperatures of 150 to 200°C. This high temperature will cause heat and energy loss if the heat is not removed and used properly. This heat can be used to produce steam for air conditioning systems or any other thermal energy consuming system.
- **Solid oxide fuel cells (SOFC):** use a solid material, most commonly a ceramic material as the electrolyte. They require high operating temperatures (800–1000°C) and can be run on a variety of fuels including natural gas.
- **Hydrogen-Oxygen Fuel Cells (Bacon Cells):** used as a primary source of electrical energy in the Apollo space program. This type of cell operates efficiently in the temperature range of 343 K to 413 K and provides a potential of about 0.9 V.
- **Molten carbonate fuel cells (MCFC):** Molten carbonate fuel cells (MCFCs) require a high operating temperature, 650°C (1,200°F), similar to SOFCs. MCFCs use lithium potassium carbonate salt as an electrolyte and this salt liquefies at high temperatures, allowing for the charge to move within the cell – in this case, negative carbonate ions. This makes MCFC systems unsuitable for mobile applications and this technology will most likely be used for

stationary fuel cell purposes. The main challenge of MCFC technology is the cells' short life span. The high-temperature and carbonate electrolyte lead to corrosion of the anode and cathode. These factors accelerate the degradation of MCFC components, decreasing the durability and cell life. Carbon-rich fuels like gases made from coal are compatible with the system. Coal itself might even be a fuel option in the future, assuming the system can be made resistant to impurities such as sulfur and particulates that result from converting coal into hydrogen. MCFCs also have relatively high efficiencies.

Fuel cells come in a variety of sizes. Individual fuel cells produce relatively small electrical potential, about 0.7 volts, so cells are "stacked" or placed in series, to increase the voltage and meet an application's requirements.

The energy efficiency of a fuel cell is generally between 40–60%, or up to 85% efficient in cogeneration if waste heat is captured for use.

The fuel cell market is growing, and Pike Research has estimated that the stationary fuel cell market will reach 50 GW by 2020.

4. MARINE (STREAM & TIDE)

Wave and tidal power are forms of hydropower that converts the energy of tides and waves into useful forms of power, mainly electricity. Although not yet widely used, tidal and wave power have potential for future electricity generation, but technology is still being developed and almost all existing installations are prototypes or pilots.

Example of a tidal plant:



La Rance Barrage is the world's first tidal power station. The facility is located on the estuary of the Rance River in Brittany, France. Opened on the 26th November 1966, it is currently operated by Électricité de France (EDF) and is the largest tidal power station in the world in terms of installed capacity. With a peak rating of 240 Megawatts, generated by its 24 turbines, it has an annual output of approximately 600 GWh. The development costs were high.

Example of wave power:



Source: Google image labeled for reuse

Wave power generation is not currently a widely employed commercial technology, although there have been attempts to use it since at least 1890. In 2008, the first experimental wave farm was opened in Portugal, at the Aguçadoura Wave Park.

SCOR's position: no existing power plants in production so must be considered as prototypes.

VIII – EXPERIMENTAL TECHNOLOGY (RESEARCH & DEVELOPMENT)

The following renewable energy risk includes technologies under research and development and the facilities installed are basically lab testing facilities, pilots and prototypes.

1. NUCLEAR FUSION

Renewable energy flows involve natural phenomena which, with the exception of tidal power, ultimately derive their energy from the sun (a natural fusion reactor) or from geothermal energy, which is heat derived for the greater part from that which is generated in the earth from the decay of radioactive isotopes, as the International Energy Agency explains.

Fusion power is the energy generated by nuclear fusion processes. In fusion reactions, two light atomic nuclei fuse to form a heavier nucleus (in contrast with fission power).

If light nuclei are forced together, they will fuse yielding energy because the mass of the combination will be less than the sum of the masses of the individual nuclei. If the combined nuclear mass is less than that of iron at the peak of the binding energy curve, then the nuclear particles will be more tightly bound than they were in the lighter nuclei, and that decrease in mass comes off in the form of energy, according to the Einstein relationship. For elements heavier than iron, fission will yield energy.

For potential nuclear energy sources for Earth, the deuterium-tritium fusion reaction contained by some kind of magnetic confinement seems the most likely path. However, for the fueling of the stars, other fusion reactions will dominate.

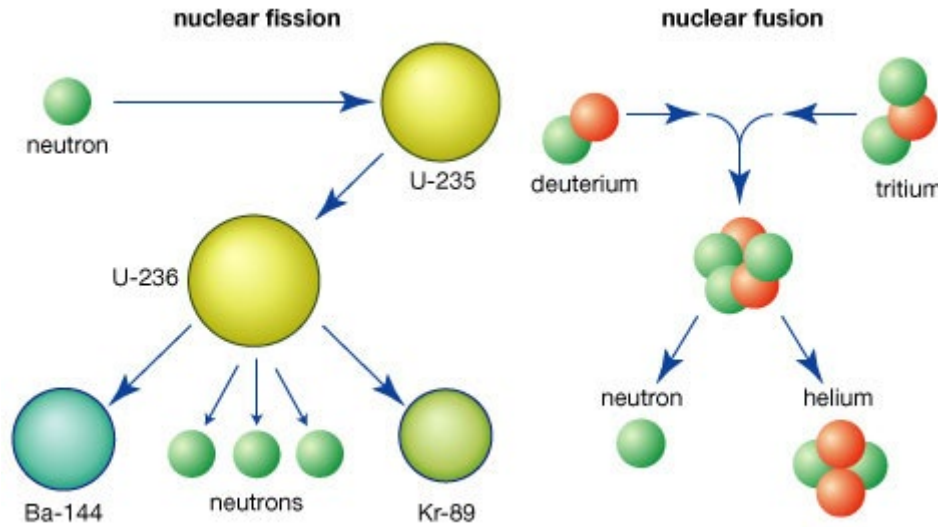

Source: Google image labeled for reuse

The term fusion power is commonly used to refer to potential commercial production of net usable power from a fusion source.

Fission fuel supply: if it is developed, fusion power would provide more energy for a given weight of fuel than any fuel-consuming energy source currently in use, and the fuel itself (primarily deuterium) exists abundantly in the Earth's ocean: about 1 in 6500 hydrogen (H) atoms in seawater (H²O) is deuterium in the form of semi-heavy water. Although this may seem a low proportion (about 0.015%), because nuclear fusion reactions are so much more energetic than chemical combustion and seawater is easier to access and more plentiful than fossil fuels, fusion could potentially supply the world's energy needs for millions of years.

In the deuterium + lithium fusion fuel cycle, (assuming current (2004) world energy consumption), the estimated supply lifespan of this fusion power is 60 million years, if it is possible to extract all the lithium from seawater. For the second easiest fusion power fuel cycle, the deuterium + deuterium burn, assuming all of the deuterium in seawater is extracted and used, there is an estimated 150 billion years of fuel, (again assuming current (2004) world energy consumption).

The leading designs for controlled fusion research use magnetic (Tokamak design) or inertial (laser) confinement of a plasma.

The strategies for creating fusion reactors are largely dictated by the fact that the temperatures involved in nuclear fusion are far too high to be contained in any material container.

The strategy of the magnetic confinement reactor is to confine the hot plasma by means of magnetic fields which keep it perpetually in looping paths which do not touch the wall of the container. This is typified by the Tokamak design, the most famous example of which is the TFTR at Princeton.

The strategy of the inertial confinement reactor is to put such high energy density into a small pellet of deuterium-tritium that it fuses in such a short time that it cannot appreciably move. The most advanced test reactors involve laser fusion, particularly in the Shiva and Nova reactors at Lawrence Livermore Laboratories.

Both approaches are still under development and are years away from commercial operation in which heat from the fusion reaction is used to operate a steam turbine that drives electrical generators, as in existing fossil fuel and nuclear fission power stations.

IX - (ELECTRICAL) ENERGY STORAGE SYSTEMS (ESS)

1. STORAGE OF ELECTRICAL ENERGY

Storage of electrical energy can be done in different ways:

- Mechanical: pumped hydro storage (PHS) (see section 6.2- HRE - Hydro & Wind El Hierro Island in Canarias archipelago)
- Compressed air energy storage (CAES); flywheel energy storage (FES)
- Electro chemical: flow batteries; sodium sulfide
- Chemical energy storage: hydrogen; synthetic natural gas (SNG)
- Electrical storage systems: double-layer capacitors (DLS); superconducting magnetic energy storage
- Thermal storage systems

ESS can be installed in wind farms, solar farms and in residential areas (for an isolated house or for a compound).



ESS can also be installed in between the user and the power connections to the grid.

2. ESS – RISK CONTROL TOPICS

Special Hazards:

Energy storage systems can include:

- Batteries
- Battery chargers
- Battery management systems,
- Thermal management
- Associated enclosures and auxiliary systems

The focus of this section is primarily on lithium-ion battery technology involving the following:

- Thermal Runaway:
 - Originates in a cell with an internal short due to internal cell defects, mechanical failures (e.g., vibration or expansion/contraction cycles), external heating, overvoltage charging or failure of the battery management system (or cell controller)
 - Cell produces gas that builds up within the cell enclosure
 - Rupture of the cell (vent failure, if any)
 - Can cascade from cell to cell and result in fire

- Electrical Fire:
 - ESS are typically installed within a building or outside a building within an enclosure.
 - Can cause property damage (i.e., exposure to the surroundings)
 - Could initiate a thermal runaway event due to localized overheating
 - Unlike lithium-(metal) batteries, lithium-ion batteries are not water-reactive.

Loss Prevention Recommendations:

Based on international standards (NFPA/FM):

- Location:
 - Outside and away from critical buildings or equipment (minimum given as per FM Global Data Sheet 1-20: 9m #30 ft using the hazard category for the exposing building occupancy. HC3: areas with generally continuous heavier combustible loading with limited quantities of ignitable liquids and/or heavier amounts of plastics. Examples include plastic manufacturing, vehicle manufacturing and assembly, as well as printing plants).
 - Minimum space separation between ESS enclosures of 20 ft (6 m).
 - Construction: minimum 1-hour fire-rated room, floors, walls and ceiling
- Protection:
 - Thermal runaway events create a large amount of heat
 - If plastic construction components are present this can lead to a very large fire.
 - Automatic sprinkler within the room or enclosure (0.3 gpm/ft² # 12 mm/min over 2500 ft²# 230m²) or the room area, whichever is smaller.
 - Fire protection may not be practical in exterior installations.
 - Best method is cooling the ESS fire with a large amount of water.
- Electrical System Protection:
 - Disconnect device (maintenance / events) for each battery rack.
 - Automatic isolation of affected modules when the battery management system (BMS) fails to operate (i.e., a fail-safe design for BMS).
 - Temperature monitoring for battery room/container (to supervised station)
 - DC ground fault
 - Protection for grounded battery systems
 - Monitoring (alarm) for ungrounded battery systems
- Electrical System Protection:
 - Overcurrent protection against overload and short-circuit faults
 - Overvoltage and undervoltage protection against overcharging and over discharging
 - Power Conversion Equipment (AC side)
 - Overcurrent protection (overload and short-circuit faults)
 - Surge arrestors for voltage transient “voltage spike” protection

X - SMART GRIDS & RENEWABLES

Current network infrastructure is not built to allow for many distributed feed-in points, and typically even if some feed-in is allowed at the local (distribution) level, the transmission-level infrastructure cannot accommodate it. Rapid fluctuations in distributed generation, such as due to cloudy or gusty weather, present significant challenges to power engineers who need to ensure stable power levels through varying the output of the more controllable generators such as gas turbines and hydroelectric generators.

As customers can choose their electricity suppliers, depending on their different tariff methods, there will be an increased focus on transportation costs. Reduction of maintenance and replacements costs will stimulate more advanced control.

A smart grid is a modernized electrical grid that uses analog or digital information and communications technology to gather and act on information, such as information about the behaviors of suppliers and consumers, in an automated fashion to improve the efficiency, reliability, economics and sustainability of the production and distribution of electricity.

The improved flexibility of the smart grid permits greater penetration of highly variable renewable energy sources such as solar power and wind power, even without the addition of energy storage (as shown below).

The smart grid allows for systematic communication between suppliers (their energy price) and consumers (their willingness-to-pay) and allows both the suppliers and the consumers to be more flexible and sophisticated in their operational strategies

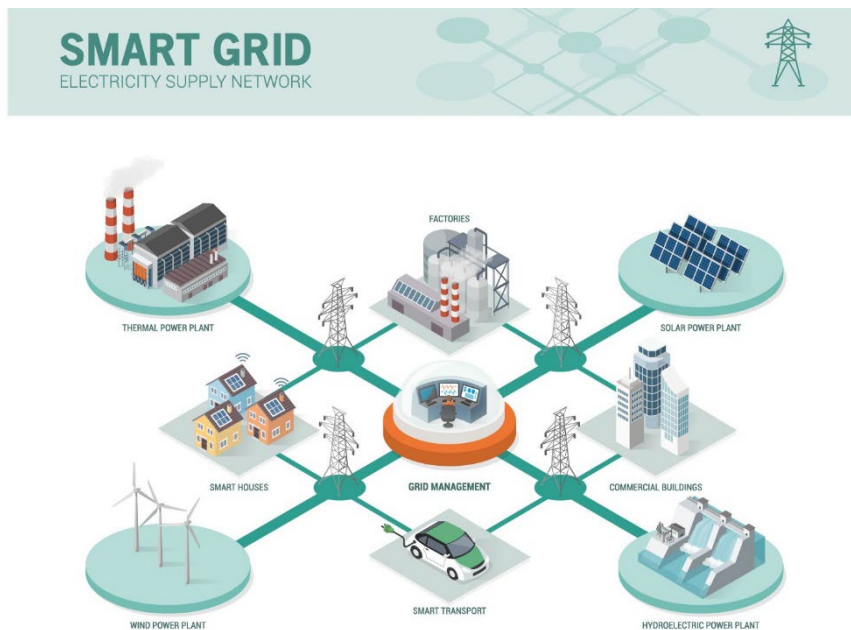

A smart grid precisely limits electrical power down to the residential level, networks' small-scale distributed energy generation and storage devices, communicates information on operating status and needs, collects information on prices and grid conditions and moves the grid beyond central control to a collaborative network.



SMART HOME

Lorem ipsum dolor sit amet, coectetur adi sed do eiusmod tempor ncididunt.

[Learn more](#)

For this very reason, smart grid technology is a necessary condition for having very large amounts of renewable electricity on the grid.

Before a utility installs an advanced metering system or any type of smart system, it must make a business case for the investment. Some components, like the power system stabilizers installed on generators are very expensive, require complex integration in the grid's control system, or are only needed during emergencies, but they are only effective if other suppliers in the network have them. Without any incentive to install them, power suppliers don't. Most utilities find it difficult to justify installing a communications infrastructure for a single application (e.g., meter reading). Because of this, a utility must typically identify several applications that will use the same communications infrastructure – for example, reading a meter, monitoring power quality, remote connection and disconnection of customers, enabling demand response, etc. Ideally, the communications infrastructure will not only support near-term applications, but also unanticipated applications that will arise in the future.

Regulatory or legislative actions can also drive utilities to implement pieces of a smart grid puzzle. Each utility has a unique set of business, regulatory, and legislative drivers that guide its investments. This means that each utility will take a different path to creating their smart grid and that different utilities will create smart grids at different adoption rates.

With the advent of cybercrime there is also concern surrounding the security of the infrastructure, primarily that which involves communications technology. Concerns chiefly center around the communications technology at the heart of the smart grid. Designed to allow real-time contact between utilities and meters in customers' homes and businesses, there is a risk that these capabilities could be exploited for criminal or even terrorist actions. One of the key capabilities of this connectivity is the ability to remotely switch off power supplies, enabling utilities to quickly and easily cease or modify supplies to customers who default on payment. This is undoubtedly a massive boon for energy providers, but also raises some significant security issues.

XI - SUPPORT FOR LOSS PREVENTION RECOMMENDATIONS

The following fire protection recommendations are based on international standards (NFPA/FM):

1. SUBSTATIONS / MCC ROOMS / SERVER ROOMS / ELECTRIC ROOMS

All Substations / MCC Rooms / Server Rooms / Electric Rooms that have no physical well-segregated back-up (a different fire / flood / other perils area located away from the main unit) which could lead to production disruption in case of a total loss should be identified. These facilities are deemed as critical.

The following solutions 1), 2) and 3) and their alternatives should be considered in detail for these critical utilities:

- 1) **Duplication:** a full back-up should be provided for these rooms. This can consist of duplicating these rooms (such as a hot site so that, in case of loss, the standby room could immediately take over, or a cold site with limited switch time for limiting interruption). The main room and the back-up room(s) should be located in different well-separated fire areas consisting of a minimum separating distance (25 m for non-combustible construction and 40 m for combustible construction) or a physical barrier (at least a 2-hour fire partition without any opening provided such as a door or even a fire door which risks being left open), false floors, ceiling penetrations or windows. An adequate as per NFPA and FM-approved automatic fire detection system should be installed in both the main room and the back-up room.

OR/AND

- 2) **Protection:** in case a back-up or redundancies are not available or cannot be fully completed as detailed in point A. above, the following fire protection alternatives should be considered:
Rooms housing electric equipment such as cable vaults, breakers, drivers, PLC cabinets, GIS bay cabinets, etc.:

For a standard size airtight room: Approved and adequate automatic gaseous extinguishing systems triggering total flooding inside the rooms and inside the cable trench / false floor / false ceiling should be considered.

For reliability, these gaseous extinguishing systems could be of the double-shot type and/or an automatic wet pipe sprinkler protection system under the ceiling which could provide an adequate back-up in the case of single / double shot gaseous extinguishing systems. Wet pipe sprinklers for trenches / false floors of at least 80 cm deep can be also considered.

OR

For a large size non-airtight room: Approved and adequate automatic wet pipe sprinklers under the ceiling and inside the cable trench / false floor / false ceiling of at least 80 cm deep should be considered. Should the site have concerns about electrical shocks and/or accidental water discharge, a pre-action system could be considered for the cabinet rooms. (For a wet pipe sprinkler and pre-action system the minimum designed density should be 6 mm/min (0.15 gpm/sq ft) over 186 m² (2000 sq ft) with K80 (K5.6) standard spray sprinklers rated at 68°C (165°F). This would be suitable for large size rooms and when it is difficult to make the room airtight for a gaseous extinguishing system).

OR

For control panels in a large size room, with a high ceiling and relatively low combustible load (i.e., GIS / control bay panels in process areas): Approved and adequate automatic gaseous extinguishing systems locally discharging inside the cabinets and inside the cable trench / false floor / false ceiling should be considered. For reliability, these gaseous extinguishing systems could be of the double shot type and/or an automatic wet pipe sprinkler protection system under the ceiling which would provide an adequate back-up in the case of single / double shot gaseous extinguishing systems. Wet pipe sprinklers for false floors of at least 80 cm deep can be also considered.

AND

Cable vaults / tunnels: Cable vaults and tunnels should be protected with an approved and adequate automatic wet pipe sprinkler protection system. Moreover, cables in open-side cable vaults exposed to wind should also be coated with adequate and FM-approved intumescent material.

AND

- 3) **Contingency Plan:** A Contingency Plan should be developed (in case of loss of the Substation or Electric Room) identifying by-pass possibilities, vendors and/or manufacturers or locations where spare cabinets are available. The lead time and installation time should be investigated by specialists. The Contingency Plan should be formalized, regularly reviewed and updated. Ownership and leadership should be clearly defined.
- 4) **Important Notes:** The following points regarding the above fire protection solutions and their potential alternatives should be considered:

Gaseous extinguishing agent: carbon dioxide (CO₂) is very dangerous for humans (lethal). As a result, for any normally occupied or occasionally occupied areas, we strongly recommend an automatic system using a safe gaseous extinguishing agent for personnel, such as "Inergen" or "Argonite" or an approved clean agent such as FE227 and FM200, in accordance with NFPA 2001. The recommended extinguishing agent density should be such that the oxygen concentration in the room does not drop below the safety limit. If a carbon dioxide system is selected for a raised floor, a special low-velocity discharge system should be used so that the carbon dioxide does not rise above knee height in the room. Under-floor halocarbon agent systems (e.g., FE227 and FM200) are not permitted when the space above the raised floor is not equipped with a halocarbon agent system. A fire in the space above the raised floor could draw the discharged halocarbon agent upwards, causing it to decompose and become very toxic. Only equipment tested and approved by a recognized laboratory should be accepted.

Ventilation Interlock: the ventilation system should be interlocked to the fire detection / protection system in order to automatically shut down upon fire detection. The ventilation interlock should allow ventilation to stop when fire is detected in a room. This is to avoid supplying oxygen to the fire and to prevent any possibility of the provided gaseous extinguishing agent escaping.

Ventilation Duct Segregation: fire dampers should be installed in each ventilation system which is common to the different rooms. These dampers should be interlocked to their respective fire detection system and should automatically close when a fire is detected in one of these rooms. Some ventilation ducts may be common to at least 2 utility rooms. Without fire dampers closing when fire is detected in a room, smoke may spread to the adjacent rooms and the gaseous extinguishing agent may also escape from the room where it has been discharged through the ventilation duct.

Water-Based Fire Protection & Electric Shocks: regarding sprinkler protection, should the plant have concerns about electric shocks, the mains switch may be interlocked to the sprinkler system in order to de-energize the area in the case of sprinkler water discharge.

Fire Water Supply: the above recommended sprinkler protection should be supplied by an adequate and reliable fire water supply in accordance with the latest version of NFPA as recommended.

Alarms and signals: all fire alarms, supervisory signals and trouble signals should be relayed to a constantly manned location.

Materials and equipment: all fire detection / protection material and equipment should be UL-listed or FM-approved and should be installed by a qualified contractor familiar with NFPA/FM standards.

Plan Review: the project should be reviewed by a qualified Fire Protection Engineer familiar with NFPA standards.

Comment:

Solution A) consisting of adequately segregated redundancies is the most reliable but also the most expensive.

Solution B) is the most efficient when A) is not possible. Automatic sprinkler wet pipe or pre-action systems are suitable for large size rooms and when it is difficult to make the room airtight for a gaseous extinguishing system.

Automatic fire protection systems can fail (i.e., faulty design, lack of maintenance, impairment). Back-up systems such as sprinklers and pre-action for gaseous extinguishing systems are therefore recommended.

Cable coating (2-hours fire-rated maximum) in cable vaults is an acceptable solution for areas handling material that could react with water (i.e., hot molten metal). This should not, however, be a systematic substitute for an automatic sprinkler in other areas. For open-side cable vaults exposed to wind that may divert water discharge, both automatic sprinklers and a coating providing mutual back-up are recommended.

Solution C) – A Contingency Plan is not a substitute for either duplication (point A. above) or automatic fire protection (point B. above). The main purpose of a Contingency Plan is to limit the Business Interruption in case of the loss of a protected room (protection can be impaired) with or without redundancies provided as per point A. In such cases, the CP aims at ensuring the availability / reliability of the redundancy(ies) if any.

The ultimate goal of this recommendation is to mitigate the impact of Business Interruption. The decision should be based on what-if and risk / benefit analyses.

2. BATTERY ROOMS (ESS)

Courtesy of Franck Orset (FPO) Loss Prevention Engineer:

Based on NFPA855 ed 2020 “Installation of Stationary Energy Storage Systems” and FM Global Data Sheet 5-33 “Electrical Energy Storage Systems”

Standard:

- Closed hydrogen systems are preferred for Energy Storage Systems (ESS).

Location:

- Batteries should be installed in a separate 1 h fire compartment.
- Energy Storage Systems (ESS) should be arranged in groups with a maximum energy capacity of 250 kWh each.
- Each group should be spaced at least 90 cm (3 ft) from other groups and from walls in the storage room or area.

The maximum rated energy should be 600 kWh.

Storage:

- No combustible storage, unrelated to the battery room, should be allowed inside the room.
- Combustible material related to the battery room should be stored at a minimum distance of 90 cm (3 ft) from the equipment.

Electrical equipment:

- All electrical equipment installed or used in battery rooms should be explosion-proof.

Direct current switchgear and inverters should not be located in the battery rooms.

Ventilation:

- Battery rooms (flooded lead-acid, flooded Ni-Cd and VRLA batteries) should be provided with natural ventilation to limit the concentration of hydrogen to 1 percent by volume (25% of the LEL – Lower Explosive Limit) and equipped with a hydrogen detection system. The hydrogen concentrations should be monitored.

OR

- Mechanical exhaust ventilation should be provided at a rate of not less than 1 cubic foot per minute per square foot (1 ft³/min/ft²) [0.0051 m³/s / m²] of floor area of the room and should be activated by a hydrogen detection system set to operate the ventilation at 25% of the LEL (1% of H₂ inside the room).

The hydrogen concentrations should be monitored.

The mechanical ventilation should remain on until the flammable gas detected is less than 25% of the LEL.

OR

- Continuous ventilation should be provided at a rate of not less than 1 cubic foot per minute per square foot (1 ft³/min/ft²) [0.0051 m³/s / m²] of the floor area of the room.

Excessive concentrations (>1 % vol.) and/or loss of ventilation and/or failure of the gas detection system should sound an alarm signal at a constantly manned location (Main Control Room).

The exhaust ventilation lines should be located at the highest level of the fire compartment.

Exception: Lithium-ion and lithium metal polymer batteries should not require additional ventilation beyond that which would normally be required for human occupancy of the space.

Detection:

- Fire detection should be provided inside the room.

Room protection:

- Battery rooms should preferably be protected by automatic sprinklers designed to deliver a minimum density of 12.2 mm/min (0.3 gpm/sq ft) over the entire area of the room or 232 m² – 2500 sq ft, - whichever is smaller.
- Thermal runaway events create a large amount of heat. The heat, coupled with plastic construction components, can lead to a very large fire. Although sprinkler protection may not be practical in exterior installations, it is the best method of cooling a fire involving ESS.
- Total flooding gas protection systems could be provided and should be designed to maintain the required design concentration within the enclosure for the time necessary to ensure that the fire is extinguished and that temperatures of the ESS have cooled to below the auto-ignition temperature of the combustible material present and the temperature that can cause thermal runaway (within a minimum of 10 minutes).
- The design of the system should be based on:
 - The agent concentrations required for the specific combustible materials involved
 - The specific configuration of the equipment and enclosure

Protections by water mist or dry chemical systems are not advised/recommended.

3. TRANSFORMERS

Notes:

- The following recommendation addresses Polychlorinated Biphenyl (PCB)-free oil-filled transformers.
- It is recommended to replace all PCB-filled transformers with PCB-free transformers. Alternatively, flush and fill the transformers with PCB-free fluid. This should be investigated with the manufacturer.

- An explosion suppression system is not a substitute for the following recommended protection. Moreover, when such systems exist, they should be FM-approved and UL-listed.

Based on NFPA 850 Recommended Practice for Fire Protection for Electric Generating Plants and High Voltage Direct Current Converter Stations:

I) Indoor oil-filled transformer exposed facilities:

In order to prevent an oil-filled transformer from severely exposing facilities inside the site in case of fire or explosion, the following fire protection solutions and their potential alternatives should be considered in detail:

- 1) The indoor oil-filled transformers should be replaced with dry-type transformers when possible.

OR

- 2) The indoor oil-filled transformers should be relocated outside the building in compliance with point 2] or attached to the building in an open cell as per point III) and well segregated from other oil-filled transformers as per point 4) below.

OR

II) The following fire separation (i.e., cut-off room) and/or fixed fire protection should be provided:

- 1) Indoor oil-insulated transformers of greater than 380L (100 gallons) oil capacity should be separated from adjacent areas by fire barriers with a 3-hour fire-resistance rating. No fixed fire protection is required as per NFPA.
- 2) Indoor transformers with a rating greater than 35 kV, insulated with a less flammable liquid or nonflammable fluid, should be separated from adjacent areas by fire barriers with a 3-hour fire-resistance rating. No fixed fire protection is required as per NFPA.
- 3) When the transformers are protected by an automatic fire suppression system (see point iv below), the fire barrier fire-resistance rating may be reduced to 1 hour.
- 4) For combustible (mineral) oil-filled transformers, the adjacent non-absorbing ground areas should also be protected with an automatic water-based spray system. The minimum density is 10 mm/min (0.25gpm/sq ft) for the surface area of the transformers and 6 mm/min (0.15 gpm/sq ft) for the non-absorbing ground areas.
- 5) If a wet pipe sprinkler system is installed, the protection should be based on a minimum density of 12.2 mm/min (0.30gpm/ sq ft) over the entire area containing the transformer(s) and extending 6.1 m (20 ft) beyond (or the entire room housing the transformers up to 232 m² [2500 sq ft]). Gas protection systems are not recommended as it is difficult to maintain the design concentration required for a sufficient length of time and the fire might flare up again when opening the door for final fire-fighting operations. Water mist systems are not recommended for reasons of reliability Adequate oil containment should be provided as per chapter VII.
- 6) For transformers with approved less flammable dielectric fluids, no fire protection is required when the equipment is located inside a one-hour fire-rated room. If the transformer is located inside a non-combustible room (but less than one-hour rated), sprinkler protection should be provided over the entire room with a minimum density of 8 mm/min (0.20 gpm/sq ft) over the entire area.

III) Oil-filled transformers in open front cells attached to the building:

The fire-resistance of the existing walls and roof of the open front cells housing the existing oil-filled transformers should be upgraded when needed in accordance with the quantity of insulating liquid in the transformer as follows:

- 1) For 0.38 cum (100US gal) or less, one of the following methods should be used:
 - a) Location within a cell of one-hour fire resistance. Moreover, an adequate and approved heat detector should be installed under the roof.

- b) Location within a cell of less than one-hour fire resistance and provided with an automatic, adequate and approved sprinkler protection (discharge density of 12.2 mm/min [0.30 gpm/ft²] over the area of the cell).
- 2) For more than 0.38 cum (100USgal), one of the following methods should be used:
 - a) Location within a cell with a fire-resistance rating of 3 hours. Moreover, an adequate and approved heat detector should be installed under the roof.
 - b) Location within a cell of one-hour fire resistance and provided with an automatic, adequate and approved sprinkler protection (discharge density of 12.2 mm/min [0.30 gpm/ sq ft] over the protected area or over the area of the cell.
- 3) Adequate oil containment should be provided as per chapter VII.
- 4) The project should be reviewed by a qualified Fire Protection Engineer familiar with NFPA standards.

IV) Outdoor oil-filled transformer exposed facilities:

In order to prevent an oil-filled transformer from severely exposing facilities inside the site in case of fire or explosion, the following fire protection solutions and their potential alternatives should be considered in detail:

- 1) The oil-filled transformers should be replaced with dry type transformers when possible.

OR

- 2) Consider any one of the following alternatives to protect the exterior walls of main buildings against exposure to outdoor transformer fires:
 - a) Provide spatial separation as indicated below (source NFPA850 Table 6.1.4.3):

Transformer Oil Capacity		Minimum (Line-of-Sight) Separation Without Firewall - X	
Cum	gal	m	ft
1.9	500	1.5	5
1.9-19	500-5,000	7.6	25
>19	>5,000	15	50

Note: the above spatial separating distances are measured from the edge of the postulated oil spill (i.e., containment basin, if provided)

- Provide a 2-hour-rated fire barrier (i.e., concrete block or reinforced concrete) with the same horizontal and vertical extent as in the table above.

Courtesy of FPO. (from NFPA 804 & 850 standards)

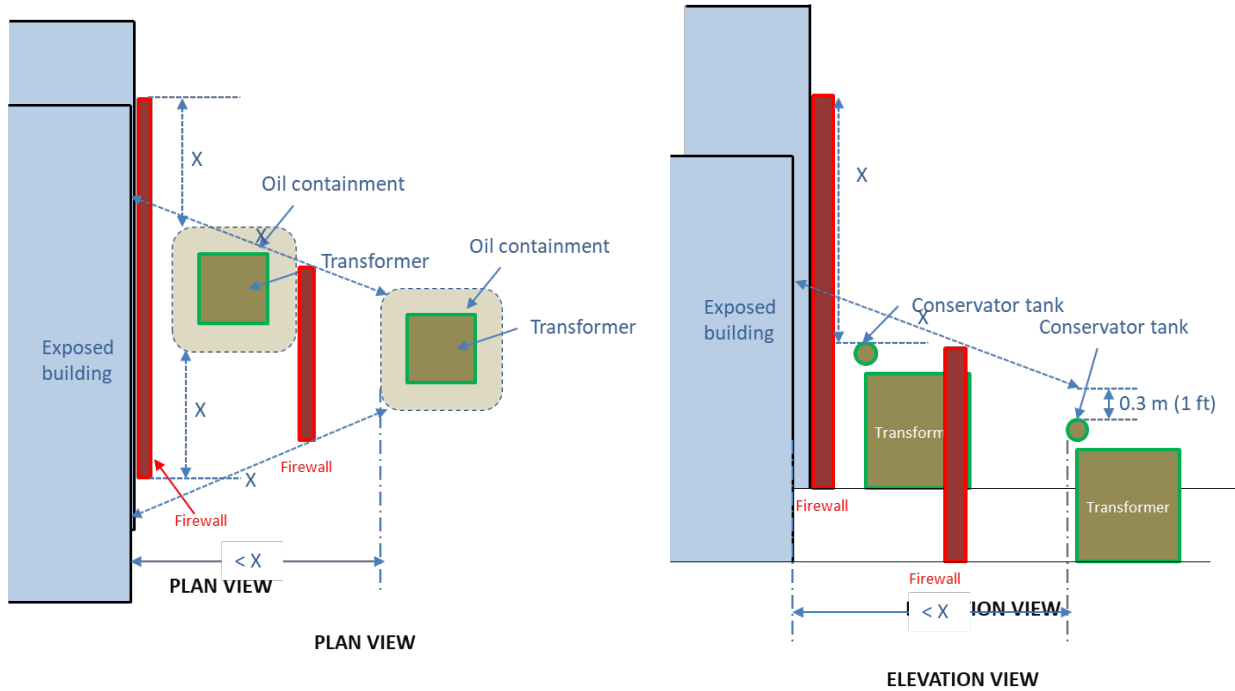

- Where a firewall is provided between structures and a transformer, it should extend vertically and horizontally in accordance with the table above as follows:

Courtesy of FPO. (from NFPA 804 & 850 standards)

Notes:

- As a minimum, the firewall should extend at least 0.3 m (1ft) above the top of the transformer casing and the oil conservator tank and at least 0.6 m (2 ft) beyond the width of the transformer and cooling radiators.
- The wall should extend up to the limit of the oil containment if its width extends beyond the 0.6 m (6 ft) indicated above.
- If columns supporting the turbine building roof (if any) at the exterior wall have a 2-hour fire-resistive rating above the operating floor, the firewall need not be higher than required to obtain line-of-sight protection up to the height of the operating floor.
- Adequate oil containment should be provided as per chapter VII.
 - Oil-filled (combustible – mineral oil) main transformer, service stations and start-up transformers not meeting the separation or fire barrier recommendations in Table 2] b. i. above should be protected with automatic water spray systems with water additives, or foam-water spray systems (source NFPA850 9.7.9).
Moreover, exposed facilities (i.e., windows or similar openings, walls not fire-rated or less than 2 hours fire-rated) should be provided with automatic fixed fire protection.
See section 6] “Automatic Fire protection for Outdoor oil-filled transformers and exposed facilities”.
Adequate oil containment should be provided as per chapter VII.
 - For transformers with approved less flammable dielectric fluids:

Courtesy of Franck Orset (FPO).

With approved less flammable transformer fluid, water spray protection and barriers are not needed if the spacing is equal to or greater than that required in the following tables.

Separation from adjacent structures

Transformer Oil Capacity	Horizontal distance (m)			Vertical distance (m)
	2 h fire resistant construction	Non- combustible construction	Combustible construction	
< 37 850	1.5	1.5	7.5	7.5
> 37 850	4.5	4.5	15	15

Table 1 – Separation Distances in m between Outdoor Less Flammable Liquid Insulated Transformers and Buildings

(from FM Global Data Sheet 5-4)

Fluid capacity in gallons	Horizontal distance (ft)			Vertical distance (ft)
	2 h fire resistant construction	Non- combustible construction	Combustible construction	
< 10 000	5	25	25	7.5
> 10 000	15	50	50	15

Table 1 – Separation Distances in ft between Outdoor Less Flammable Liquid Insulated Transformers and Buildings

(from FM Global Data Sheet 5-4)

This means that if the above-mentioned minimal separation is maintained, neither fire suppression nor barrier walls are required.

When the above-mentioned distances are not met, a 2-hour firewall should be provided between structures and a transformer. It should extend vertically and horizontally using the distance given in the table 1 as indicated in the diagram of section iii. above.

V) Outdoor oil-filled transformers mutual exposure:

In addition to the passive fire protection for surrounding facilities recommended in points I) and II) above, oil-filled transformers - when not in an individual cell - should be separated from the other transformers by:

- 1) a minimum separating distance as given in the table 2] b. i. above

OR

- 2) a 2-hour-rated fire barrier extending at least 0.3 m (1ft) above the top of the transformer casing and oil conservator tank and at least 0.6 m (2ft) beyond the width of the transformer and cooling radiators as shown below:

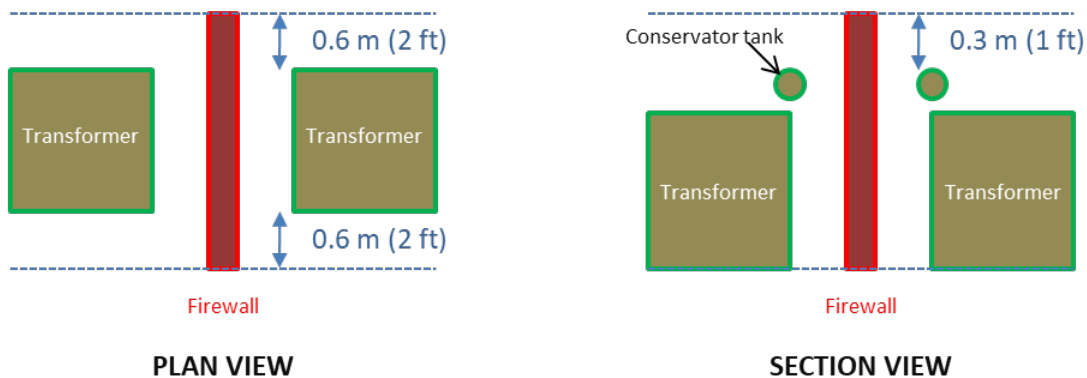

Courtesy of FPO. (from NFPA 804 & 850 standards)

Notes:

Client Guidance Note – Risk Control Practice

- Where a firewall is provided, it should be designed to withstand the effects of projectiles from exploding transformer bushings or lightning arresters.
- A higher non-combustible shield may be provided to protect against the effects of an exploding transformer bushing.
- The wall should extend up to the limit of the oil containment if its width extends beyond the 0.6 m (2ft) indicated above.

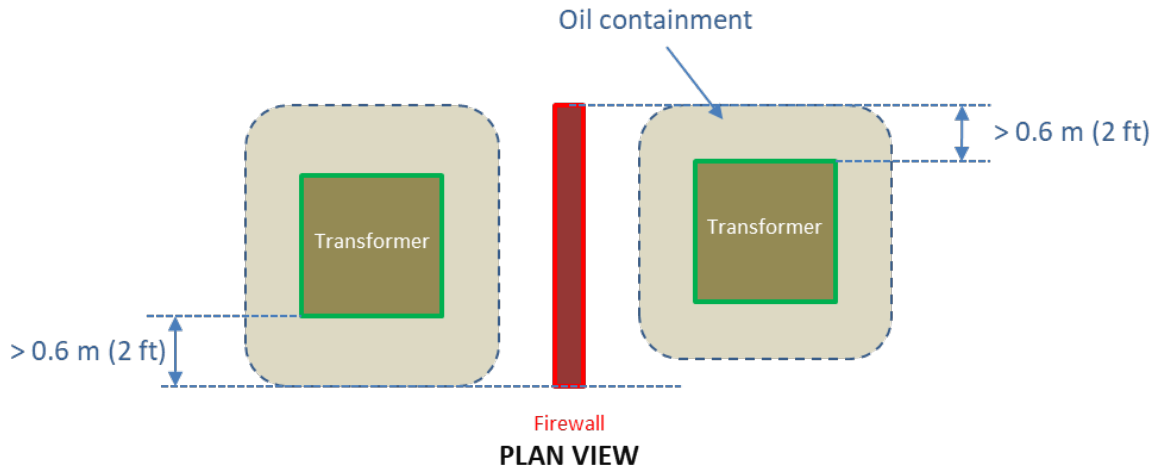

Courtesy of FPO. (from NFPA 804 & 850 standards)

- If columns supporting the turbine building roof (if any) at the exterior wall have a 2-hour fire-resistive rating above the operating floor, the firewall need not be higher than required to obtain line-of-sight protection up to the height of the operating floor.
- Fixed fire protection should be considered as per section 6] for oil-filled transformers
- Adequate oil containment should be provided as per section VII.
 - For transformers with approved less flammable dielectric fluids:

Courtesy of Franck Orset (FPO).

Separation from adjacent transformers is given in Table 2:

Fluid capacity in liters	Min. separation in meters
< 37 850	1.5 m
> 37 850	7.5 m

Table 2 – Outdoor Less Flammable Fluid Insulated Transformer Equipment

Separation Distances in m between adjacent transformers

(from FM Global Data Sheet 5-4)

Fluid capacity in gallons	Min. separation in ft
< 10 000	5 ft
> 10 000	25 ft

This means that if the above-mentioned minimal separation is maintained, neither fire suppression nor barrier walls are required.

Client Guidance Note – Risk Control Practice

When the above-mentioned distances are not met, a 2-hour firewall should be provided between transformers. It should extend vertically and horizontally as indicated in the figure of section ii. above.

Fixed fire protection should be considered as per section 6] for oil-filled transformers.

Adequate oil containment should be provided as per section VII.

VI) Illustration of outdoor oil-insulated transformer exposed facilities and mutual exposure spacing as per points 4) and 5) above

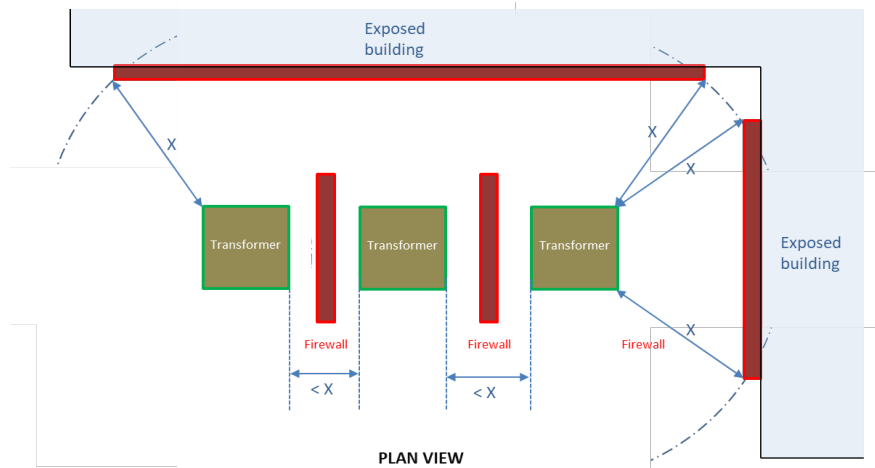

Courtesy of FPO

- Fixed fire protection should be considered as per section VI for oil-filled transformers and exposed facilities.
- Adequate oil containment for oil-filled transformers should be provided as per section VII.

VII) Automatic fire protection for outdoor oil-filled transformers and exposed facilities:

1) Fixed fire protection for outdoor oil-filled transformers:

a) The following fixed fire protection is suitable for:

- Oil-filled (combustible – mineral oil) main transformer, service stations and start-up transformers not meeting the separation or fire barrier recommendations in Table 2] b. i. above.
- Reducing the lead time due to the manufacture and shipping of a new transformer by allowing repairs when possible considering that the fire would then be controlled at an early stage of development.

Design density:

- Not less than 10.2 L/min/m² (0.25 gpm/ft²) of the projected area of the rectangular prism envelope for the transformer and its appurtenances, and not less than 6.1 L/min/m² (0.15 gpm/ft²) on the expected non-absorbing ground surface area of exposure.
- The spray system should be activated by a pilot line or FM-approved fire detection system. Note that in recent years some transformers have been designed with relatively high design temperatures. Operation of the cooling fans can release large amounts of heat that can inadvertently trip deluge systems using rate-of-rise or rate-compensated heat detection equipment. To avoid these inadvertent trips, fixed temperature heat detection systems should be used to activate transformer deluge water spray systems.
- Adequate oil containment should be provided as per section VII.
- Nozzles should be positioned so that the water spray does not envelop energized bushings or lightning arresters by direct impingement (unless authorized by the manufacturer).
- Detection of a fire should preferably be undertaken by the use of sprinkler heads, set into a separate air-pressurized line (pilot line).

- b) For transformers with approved less flammable dielectric fluids:
- When the minimum required distances are not met and/or when the transformers could expose adjacent structures, buildings or major equipment, automatic water spray systems should be installed.
 - These transformers should be installed within concrete shields protecting buildings and other transformers from heat and smoke.
 - Transformers, including the adjacent non-absorbing ground areas should be protected with an automatic water-based spray system.
 - The minimum density is 10 mm/min (0.25gpm/sq ft) for the surface area of the transformers and 6 mm/min (0.15gpm/sq ft) on the non-absorbing ground areas.
 - Nozzles should be positioned so that the water spray does not envelop energized bushings or lightning arresters by direct impingement (unless authorized by the manufacturer).
 - Detection of a fire should preferably be undertaken by the use of sprinkler heads, set into a separate air-pressurized line (pilot line).

2) Fixed fire protection for exposed facilities:

- a) For protection of windows or similar openings, the following design criteria should be considered:
- Sprinkler heads should be positioned within 5 cm (2") of the top of the window and 30 cm (12") from the window surface. For windows up to 1.5 m (5 ft) wide, only one sprinkler head is required to protect the openings. For windows from 1.5 (5 ft) to 3.7 m (12 ft) wide, 2 sprinkler heads are required.
 - Sprinkler heads should be positioned so that a certain amount of water discharge can run down the side of the building and cool the exposed surface. Provisions should be made so that the water remains in contact with the wall and/or window surface while running down. Special consideration should be given to potential wind effects, so that the surface can be properly wetted.
- b) For the protection of openings in a fire separation wall, the following design criteria should be considered:
- Water curtain: sprinklers in a water curtain should be hydraulically designed to provide a minimum discharge of 37 L/min (10 gallons/min) per lineal meter of water curtain, with no sprinkler head discharging less than 57 L/min (15 gallons/min) (minimum operating pressure of 0.5 bars (7 psi) for K80 (K5.6) sprinkler heads).
 - Sprinkler exposure protection (automatic sprinkler or deluge systems)
 - Protection should be hydraulically designed to provide a minimum operating pressure of 0.5 bars (7 psi) with all sprinklers facing the exposure and fully operating (or all of the deluge heads for a deluge system).
- c) For the protection of an exposed wall (not fire-rated or less than 2-hour fire-rated), the following design criteria should be considered:
- The protection should be provided to cover the entire surface represented by the minimum distance indicated below:

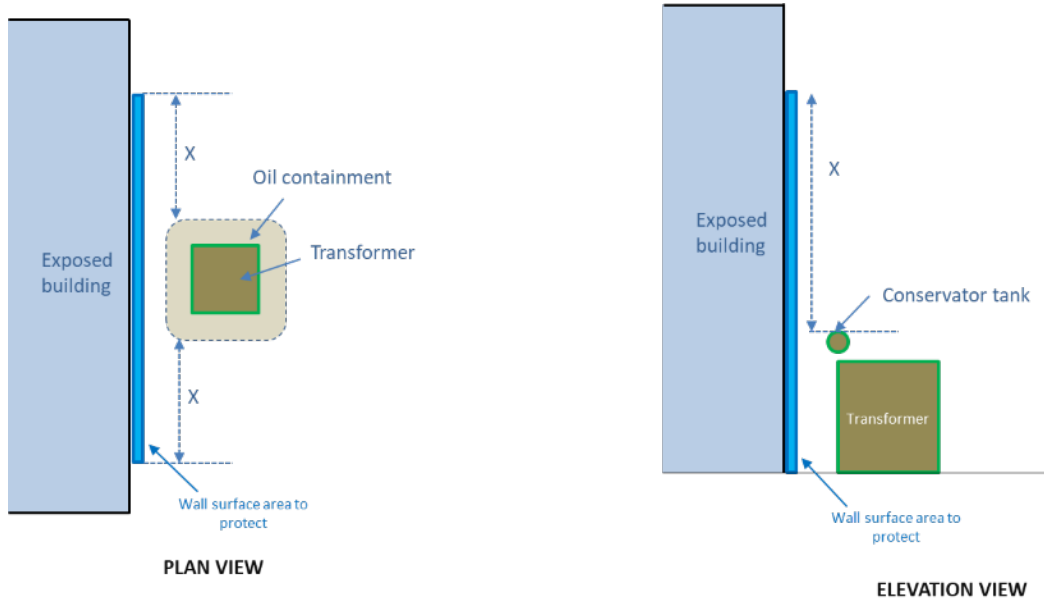

With:

$x = 7.5$ m (15 ft) if the transformer’s oil capacity is $< 18\,900$ l (5000 gallons) and 15 m (50 ft) if the transformer’s oil capacity is $> 18\,900$ l (5000 gallons).

- The transformer should be located at least 1.5m (5 ft) from the wall.
- The sprinkler protection should be designed to deliver a minimum density of 8 mm/min (0.20 gpm/sq ft) over the entire surface, with a design for direct impingement application, or should provide a rundown application with a maximum distance between levels of 3 m (10 ft).

Sprinkler heads location: for wall protection systems, sprinkler heads should be located 15 cm (6”) to 30 cm (12”) from the wall surface and within 15 cm (6”) from the top of the wall, with a maximum spacing of 2.4 m (8 ft) between sprinkler heads.

- d) When water curtain protection is provided for a wall (protection against external exposure) because of the presence of openings (windows, louvers, walls with combustible insulation...), the sectional valve for the supply of the water curtain should be from a water supply that is independent from that used for the protection of the transformer.

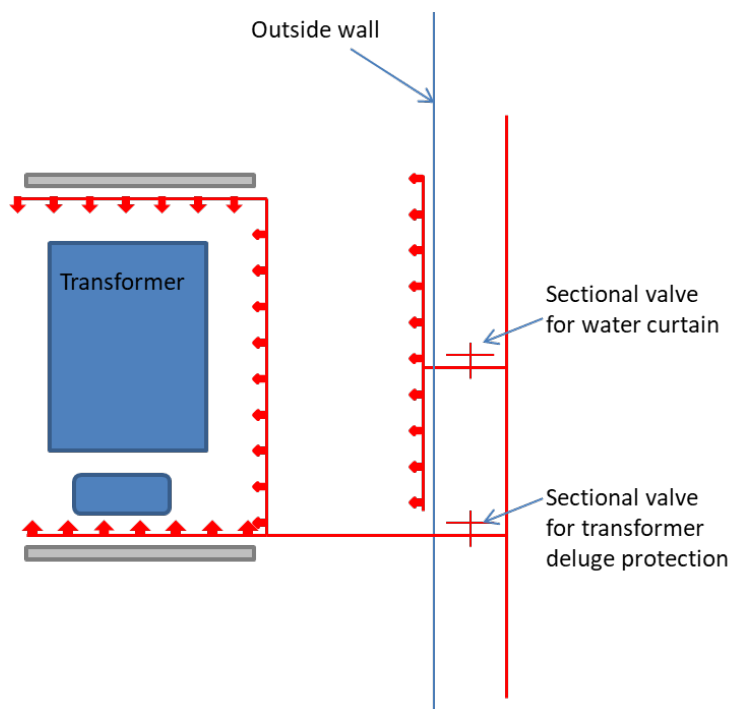

Courtesy of Franck Orset (FPO)

This is to be sure that in case of failure of the deluge protection on the main transformer it is still possible to isolate the sectional valve controlling the transformer without affecting the water flow on the water curtain.

- Oil containment:
 - Outdoor liquid-filled transformers should be provided with spill containment if an accidental release of the transformer fluid could expose a main building or adjacent equipment or storage to fire damage.
 - A catch basin should be provided beneath each transformer, with sufficient capacity to hold 120% of the oil contents of the transformer, or a retention system with a drain that syphons off to an underground tank.
 - The area of the bund should be sufficient to be able to capture all oil ejected from pressure relief devices, ruptured bushing turrets, main tanks, oil coolers and the conservator.
 - The provision of crushed stones is a good practice to prevent large fires at the transformer location.
 - In the event of a transformer failure the spilling oil will effectively be cooled down by the yard stone to below the combustion temperature. The stones will prevent the oil from burning out of control throughout the containment area.
 - Only the area that was exposed to the oil spill will have surface oil that will burn until dry. This will minimize the actual time and severity of the fire due to the limited amount of surface oil and the reduction in oil temperature.
 - In passive systems with crushed stones, no less than 300 mm (12 in.) of stone should be provided to extinguish the oil if on fire. Smaller stones are more effective, 20 mm to 40 mm ($\frac{3}{4}$ in. to 1½ in.) are recommended. While larger stones permit quicker penetration by the oil, their size makes them less effective as quenching stones.
 - The volume of the bunding and the rock ballast must be sufficient to hold the total volume of oil from the transformer at 100 mm (4 in.) below the surface of the rocks to ensure that a pool fire is not sustained.
 - Note that rock ballast tends to collect dust and other wind-borne debris over time and may silt up and require cleaning at infrequent intervals.
 - A system for removal of rainwater from the containment area should be provided.

4. STEAM TURBINE GENERATORS

With the kind and invaluable support of Frank Orset, Loss Prevention Engineer:

Inadequate fire-protection systems and a lack of proper emergency protocols can lead to serious damage and extended outages in the event of a lube-oil fire at a turbine-hall.

Oil releases of pressurized-oil systems used in bearing lubrication, seal oil, hydraulics or control systems are most often caused by electrical failure, fitting failures, operator error or vibration. This may cause a spray fire, a pool fire or a three-dimensional spill fire.

Adequate, reliable, and approved fire protection systems should be installed to protect the steam turbine generator as well as the lubrication oil group. The systems should take guidance from the recommended practices of “NFPA 850 Recommended Practice for Fire Protection for Electric Generating Plants and High Voltage Direct Current Converter Stations, 2020 Edition” or FM Global Data Sheet 7-101 “Fire Protection for Steam Turbines and Electric Generators”, with some additional remarks:

Turbine generator operating floor

Turbine generator bearings should be protected with an automatic closed-head sprinkler system using directional nozzles. Automatic actuation is more reliable than manual action. Fire protection systems for turbine generator bearings should be designed for a density of 10.2 mm/min (0.25 gpm) over the protected area of all bearings.

Client Guidance Note – Risk Control Practice

Note that “NFPA 804 Standard for Fire Protection for Advanced Light Water Reactor Electric Generating Plants 2020 Edition” & “805 Performance-Based Standard for Fire Protection for Light Water Reactor Electric Generating Plants, 2010 Edition” require a density of 12.2 mm/min/sq m (0.3 gpm/sq ft) and Factory Mutual requires a minimum flow of 113 l/min (30 gpm) per nozzle.

This system comprises one to two closed 90-degree directional spray nozzles over each bearing and directed at the shaft seal. The nozzles should be rated at approximately 83°C (150°F) above the highest ambient temperature.

These nozzles should also be located approximately 60 cm (2 ft) from the shaft at the 10 and 2 o'clock positions, thus providing the proper spray pattern, cooling and flushing of any oil spray/leak below the turbine deck.

Additionally, one heat detector rated at approximately 30°C (86°F) above the highest ambient temperature should be installed 60 cm (2 ft) directly above the shaft.

In the case of a fire, the heat released by the fire triggers the heat detectors, which in turn open the valve.

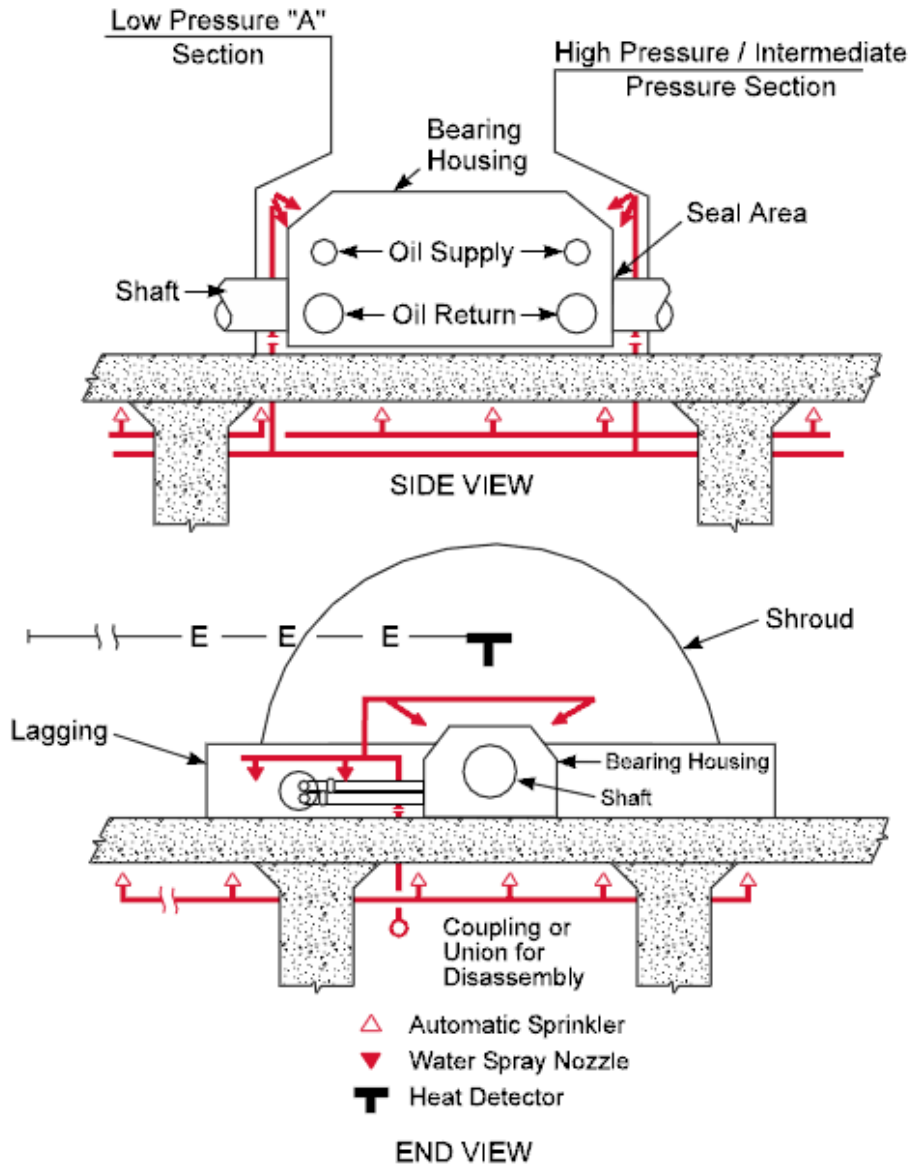

(FM Global Data Sheet 7-101 “Fire Protection for Steam Turbines and Electric Generators”) Posted and reprinted with permission of FM Global. ©2011-2014 Factory Mutual Insurance Company. All rights reserved.

Protection for bearing housing and areas under turbine skirts

Accidental water discharge on bearing points and hot turbine parts should be considered, hence a pre-action system as said above is recommended. If necessary, these areas can, in addition, be protected by shields and encasing insulation with metal covers.

If turbine generator bearings are protected with a manually operated sprinkler system, the following should be provided:

- Manual activation should be from the control room or a readily accessible location not exposing the operator to the fire condition. Staff at the plant should be sufficiently trained to promptly handle this situation as well as other responsibilities during an emergency of this nature.
- Automatic fire detection should be provided over the area of each bearing and within the skirting of the turbine where a potential for oil to pool can alert operators to a fire condition.
- Documented procedures should be in place with authority given to operators to activate the system, if necessary, in a fire condition.
- Periodic training should be given to operators regarding the need for prompt operations of the system.
- Regular inspections of the sprinkler & detection system should be conducted to always ensure proper functionality.

Automatically actuated systems have proven to actuate properly under fire conditions and are not prone to spurious actuation. If a manually operated water system is installed, consideration should be given to a supplemental automatic gaseous fire extinguishing system.

Accidental water discharge on bearing points and hot turbine parts should be considered. If necessary, these areas may be protected by shields and encasing insulation with metal covers.

The decision for the installation of fire protection systems subject to accidental water discharge on the turbine generator bearings and hot turbine parts must be a local management decision. Alternatives should consist of the use of special fire protection gaseous agents in accordance with NFPA / FM Standards.

All areas beneath the turbine generator operating floor that are subject to oil flow, oil spray or oil accumulation should be protected by an automatic sprinkler or a foam-water sprinkler system.

This coverage normally includes all areas beneath the operating floor in the turbine building.

The sprinkler system beneath the turbine generator should take into consideration obstructions from structural members and piping and should be designed to deliver a density of 12.2 mm/min (0.3 gpm/sq ft) over a minimum application of 465 m² (5000 sq ft) with standard spray sprinkler heads rated at 141°C (286°F) (K115 (K8.0) preferably) for a roof height up to 4.5 m (15 ft).

If there is no intermediate protection below the mezzanine or over areas with a pool fire hazard, for a roof height between 4.5 and 9 m (15 and 30 ft), the sprinkler system should be designed to deliver a density of 16 mm/min (0.4 gpm/sq ft) over a minimum application of 465 m² (5000 sq ft) with standard spray sprinkler heads preferably rated at 141°C (286°F) (K160 (K11.2)).

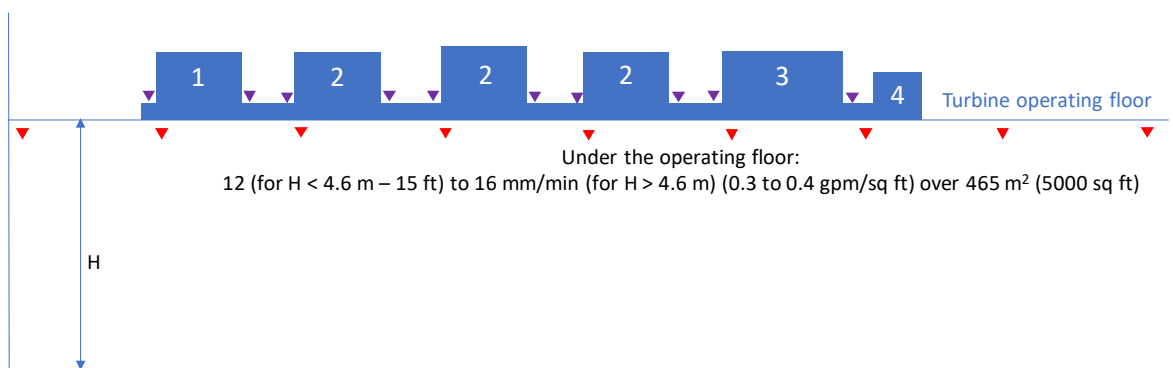

Sprinkler protection with no intermediate levels

Posted and reprinted with permission of FM Global. ©2011-2014 Factory Mutual Insurance Company. All rights reserved.

When grated mezzanines are provided below the operating floor, additional sprinkler protection should be provided below, as well as at intermediate levels where oil spills are prone to accumulate.

The sprinkler system beneath the turbine generator should take into consideration obstructions from structural members and piping and should be designed to deliver a density of 12.2 mm/min (0.3 gpm/sq

ft) over a minimum application of 465 m² (5000 sq ft) with standard spray sprinkler heads preferably rated at 141°C (286°F) (K115 (K8.0)).

The density below the grated mezzanines should be designed, depending on the height between the sprinklers and the ground, as for the protection below the operating floor over 232 m² (2500 sq ft) for the lower mezzanine and 12.2 mm/min (0.3 gpm/sq ft) over 140 m² (1500 sq ft) for the intermediate levels. The temperature rating of the sprinkler heads below the mezzanines can be an ordinary or high temperature.

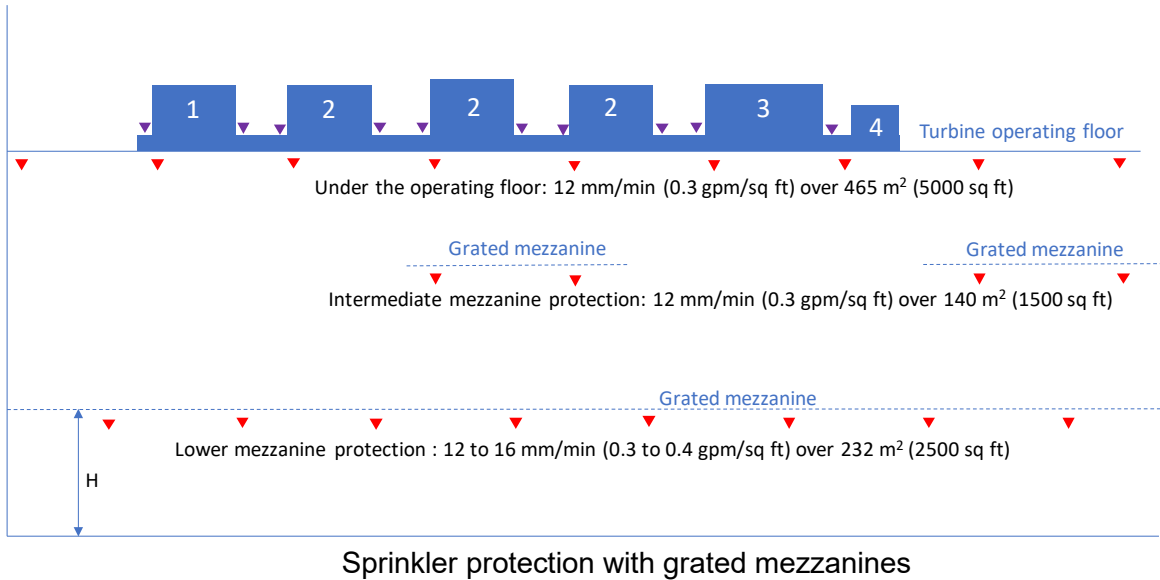

Posted and reprinted with permission of FM Global. ©2011-2014 Factory Mutual Insurance Company. All rights reserved.

Lubricating oil lines above the turbine operating floor should be protected with an automatic sprinkler system covering those areas subject to oil accumulation including the area within the turbine lagging (skirt). The automatic sprinkler system should be designed to deliver a density of 12.2 mm/min (0.3 gpm/sq ft) with standard spray sprinkler heads preferably rated at 141°C (286°F) (K115 (K8.0)).

The lubrication group:

Lubricating oil reservoirs and handling equipment should be protected by an automatic sprinkler or foam-water sprinkler system.

The sprinkler system should take into consideration obstructions from structural members and piping and should be designed to deliver a density of 12.2 mm/min (0.3 gpm/sq ft) over a minimum application of 465 m² (5000 sq ft) with standard spray sprinkler heads preferably rated at 141°C (286°F) (K115 (K8.0)).

If the lube oil reservoir is elevated, sprinkler protection should be extended to protect the area beneath the reservoir.

Note:

In some particular circumstances, there is no ceiling above the lube oil tanks and there is no technical possibility to provide a reliable way of collecting the convective heat plume at the sprinkler head position.

In these situations, the above-mentioned protection would not be reliable and should be replaced with the following protection:

The protection on the lube oil tanks should be based on a deluge system with open sprinkler heads and a designed density of 12 mm/min (0.3 gpm) over the entire area of the lube oil tanks.

The system should be activated either by a pilot line (68°C (154°F) (rated sprinkler heads provided with heat collector plates above the detector heads would be preferable) or an appropriate fire detection system.

Client Guidance Note – Risk Control Practice

An additional way of manually activating the deluge system from a remote and safe area should be provided (in case the detection system is not working for any reason).

The plant should be designed, and equipment arranged, so that lubricating oils will be confined to a specified area. The use of trenching, curbs and dikes, plus the utilization of natural holding sumps, such as condenser pits, can serve as an aid in accomplishing this function.

As a preferred approach, turbine lube oil storage tanks and reservoirs should be cut off from all other areas of the turbine building by 180-minute fire-resistant barriers.

A properly engineered fixed fire extinguishing system (see above) should be provided throughout all such enclosures.

Where oil storage tanks are not cut off from other areas, they may be acceptable provided that:

- they are located in areas where the ceiling is protected by an overhead sprinkler system and the sprinkler protection extends sufficiently into the peripheral areas subject to oil spray and oil flow, to control the heat produced by oil fires and maintain building temperatures below those which cause deformation of the structures.
- the tanks are protected by an automatic water spray system.
- an oil containment system is installed in accordance with the Standards.

To prevent potential damage from the effects of water spray, emergency lube oil pumps should be of the enclosed type with the electrical circuits to the oil pump motors routed and protected so that control will not be impaired by the fire emergency.

Turbine oil reservoirs and lube oil filters equipped with hinged access panels designed to relieve internal pressure should have tamper resistant devices installed so that pressure relief of the tank is not impaired, e.g., locked cages can be installed over the covers in such a way that the covers can be lifted.

Non-condensable vapor extractors should be vented outdoors.

Cables for operating the lube oil pumps should be protected from fire exposure. Protection can consist of a separation of cables for the AC and DC oil pumps, or a 1-hour fire-resistive coating (derating of cables should also be considered).

If the lubricating oil equipment is in a separate room enclosure, protection can be provided by a total flooding gaseous extinguishing system (e.g., CO₂, designed to deliver a minimum concentration of 34% for at least 20mins).

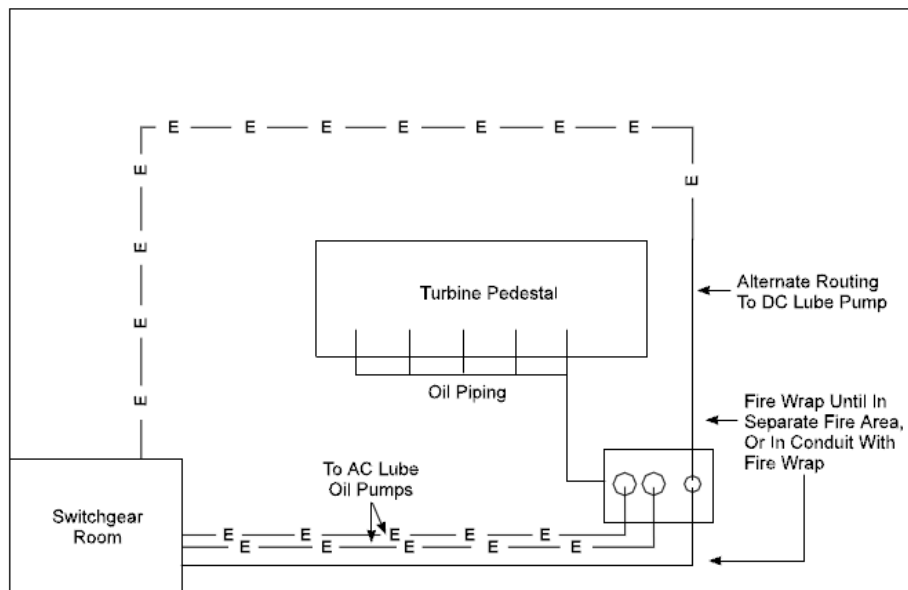

Posted and reprinted with permission of FM Global. ©2011-2014 Factory Mutual Insurance Company. All rights reserved.

Exciter:

The area inside a directly connected exciter housing should be protected with a total flooding automatic carbon dioxide system, designed to deliver a minimum concentration of 34% for at least 20 min. (or during the total coast down period of the machine if longer than 20 min.). The purpose is to protect the bearings inside the exciter housing.

Although the extension of the bearing pre-action water spray system to the exciter enclosure is an acceptable means of fire protection, the installation of an automatic total flooding carbon dioxide system (CO₂) is preferred over water spray.

When not directly connected, the exciter is not considered as being directly exposed to the turbine generator and the protection is not required.

- **Hydrogen seal oil:** Hydrogen seal oil units should be protected by an automatic sprinkler or foam-water sprinkler system. The sprinkler system should take into consideration obstructions from structural members and piping and should be designed to deliver a density of 12.2 mm/min (0.3 gpm/sq ft) over a minimum application of 465 m² (5000 sq ft) (or entire area if smaller than 465 m² (5000 sq ft)) with standard spray sprinkler heads preferably rated at 141°C (286°F) (K115 (K8.0)). The seal oil units should preferably be located in a fire cut-off area. When these systems are not cut off, the sprinkler protection should extend sufficiently into the peripheral areas subject to oil spray and oil flow, to control the heat produced by oil fires and maintain building temperatures below those which cause deformation of the structures.
- **Feed water pumps:** The sprinkler system should be designed to deliver a density of 12.2 mm/min (0.3 gpm/sq ft) over a minimum application of 465 m² (5000 sq ft) (or entire area if smaller than 465 m² (5000 sq ft)) with standard spray sprinkler heads preferably rated at 141°C (286°F) (K115 (K8.0)). The feed water pumps should preferably be located in a fire cut-off area or at least provided with fire separation between the different units.
- **Oil storage areas / Discharge tank area:** Clean or dirty oil storage areas should be protected with a density of 12.2 mm/min (0.3 gpm/sq ft) over a minimum application of 465 m² (5000 sq ft) with standard spray sprinkler heads preferably rated at 141°C (286°F) (K115 (K8.0)). As this area generally represents the largest concentrated oil storage in the plant, separation, ventilation and drainage should be provided in addition to the automatic protection. The oil storage tanks should preferably be located in a fire cut-off area.
- **Cable concentrations in the turbine hall:** In addition (if not included in the above-mentioned protection), large concentrations of cable trays below the turbine floor should also be protected by an automatic sprinkler system.
The sprinkler system should be designed to deliver a minimum density of 12.2 mm/min (0.3 gpm/sq ft) over the entire area (with a maximum operating area of 232 m² (2500 sq ft)).
The sprinkler heads should be rated at 68°C (154°F) (K80 (K5.6)).
- **Hydrogen:** Hydrogen cylinders should be stored outside or in a separate well-ventilated enclosure. Indoor storage of hydrogen cylinders should be protected by a sprinkler or water spray system designed to deliver 12.2 mm/min over 232 m² (0.3 gpm/sq ft over 2500 sq ft) with K80 (K5.6) spray sprinklers, preferably rated at 141°C (286°F). [or entire area with water spray systems].
The protection should be extended 6 m (20 ft) beyond the storage area.
An excess flow valve and an emergency shutoff valve should be provided on the supply line where hydrogen is supplied from a large central storage remote from the building. The emergency shut off valve should be at a readily accessible location and arranged for remote operation from the control room.
- **Emergency hydrogen drainage valve:** The generator hydrogen dump valve and hydrogen draining equipment should be arranged to vent directly to a safe outside location. The dump valve should be remotely operated from the Main Control Room and manually from an area accessible

during a machine fire (preferably located outside the main building, in an area not exposed by adjacent equipment such as transformers).

- Combustible roof for turbine hall building:** If the roof of the turbine hall is of a combustible construction (either a combustible insulation material such as polyurethane or expanded polystyrene or a non-combustible insulation, such as foam glass, but glued to the roof metal panels with bitumen), it should be replaced with a non-combustible construction system (such as rockwool mechanically fastened on the steel deck assembly) or sprinkler protection should be provided. The minimum designed density for sprinkler protection should be 8 mm/min (0.2 gpm/sq ft) over 465 m² (5000 sq ft) (wet system) or 740 m² (8000 sq ft) (dry system) with 141°C (286°F) rated spray sprinkler heads.

- Additional specifications:** 180 m³/h (792 gpm) should be provided for the manual firefighting needs in the turbine hall area (hydrants and hoses). Note that NFPA recommends 113 m³/h (500 gpm), which is also acceptable. Sprinklers also need to be provided under obstructions wider than 1.2 m (4 ft), such as large piping and valves, and under the condenser as this is an area where burning oil can accumulate.

If a mezzanine is present, sprinklers must be provided for each level below the turbine deck.

Lube oil purifiers should be located in an area protected by an overhead sprinkler system and an oil containment system.

Spill containment curbs prevent the pool fire from spreading outside the sprinkler-protected area. Proper drainage to prevent burning oil from being floated to unprotected areas of the plant should be provided for all combustible/flammable type oil hazards.

Electrical equipment in the area covered by a water or foam-water system should be of the enclosed type or otherwise protected to minimize water damage in the event of system operations. To extinguish a three-dimensional spray oil fire in the turbine bearing and oil pipe areas, a water spray system with a design water density of 40 to 60 mm/min (1 to 1.5 gpm/sq ft) may be recommended.

Commonly used water spray densities of 12 to 20 mm/min (0.3 to 0.5 gpm/sq ft) will protect and cool machinery and building constructions, but not necessarily extinguish a three-dimensional fire. The area that should be protected on the operating floor depends on curbing and drainage but should generally be extended to a distance of 6 m (20 ft) around the turbine-generator.

The operating temperature of the sprinkler heads should be set at 30°C (86°F) above the highest expected ambient temperature.

- Sketch of the automatic protection location overview in the turbine hall**

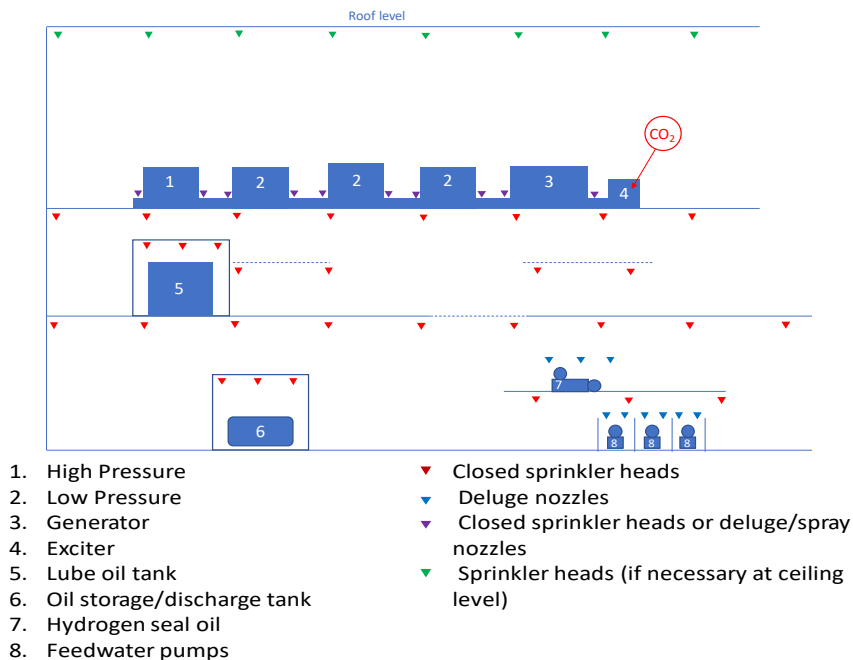

Posted and reprinted with permission of FM Global. ©2011-2014 Factory Mutual Insurance Company. All rights reserved.

5. COOLING TOWERS (FOR STEAM TURBINES)

Several fires during maintenance periods in the cooling tower (dry conditions) are recorded each year. Cooling towers can be made of various materials as follows:

- external shell made of combustible fiber, reinforced plastic or concrete
- packing inside the cooling tower made of combustible plastic or wood

The above combustible material, in dry conditions during the maintenance period, may be ignited during hot work operations given the relatively high continuity of combustibles and the combustible load. The fire would spread all over before any emergency response using manual fire-fighting equipment can be organized. This would lead to a relatively long Business Interruption period in the case of a non-standard packaged cooling tower set. Based on our experience, around four months would be needed for an entire cooling tower set.

The following solutions A) or B) should be considered in detail for mitigating the loss of a non-standard packaged cooling tower set:

Contingency Plan: A Contingency Plan should be developed in case of loss of the cooling tower. It should identify process cooling alternatives, vendors and/or manufacturers or locations where entire sets are available. The study should include the loss of an entire set of cooling towers, comprising several cells without fire separation.

OR

Protection: in case the above Contingency Plan is not acceptable from a Business Interruption standpoint, critical cooling towers (having a direct impact on production) should be adequately protected by approved sprinkler protection as per NFPA 214/ FM Global Data Sheet 1.6. All material and equipment should be approved and/or listed. The project should be reviewed by a qualified Fire Protection Engineer familiar with NFPA standards. All alarms should be relayed to a constantly manned location. This protection should be supplied from an adequate and reliable Fire Water supply.

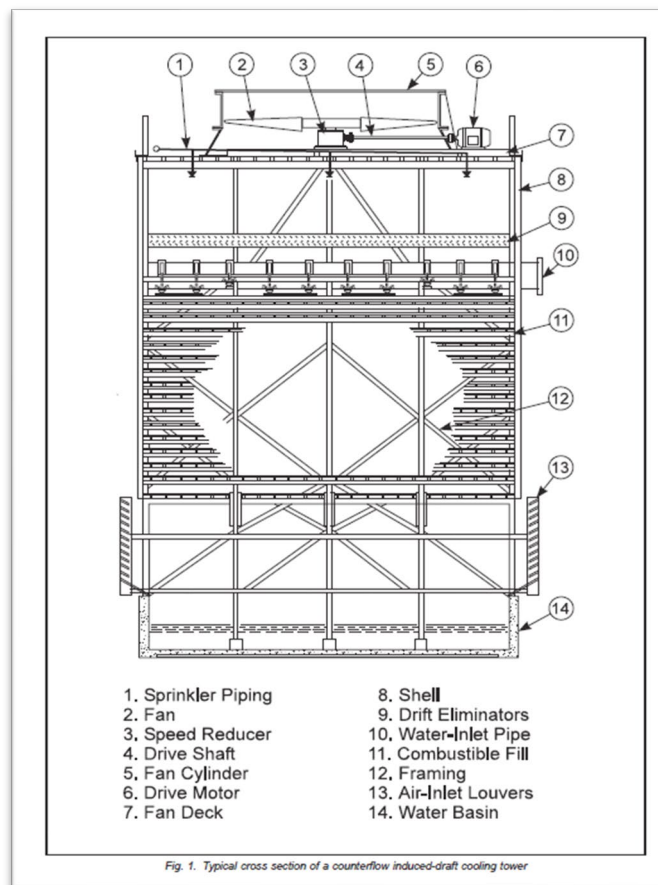

Client Guidance Note – Risk Control Practice

FM Global Data Sheet 1-6 “Cooling Towers”. Fig. 1, 2, 3 and 4. Posted and reprinted with permission of FM Global. ©2020 Factory Mutual Insurance Company. All rights reserved.

Minimum recommended density as per FM Global Data Sheet 1-6:

- For cementitious fill and a combustible fan deck: wet pipe / dry pipe of 6 mm/min (0.15 gpm/ft²)
- For a combustible fan deck: wet pipe / dry pipe of 14 mm/min (0.35 gpm/ft²)
- For a combustible fill & fan deck: deluge, 20 mm/min (0.50 gpm/ft²)

Minimum rate of application as per NFPA214:

- Deluge, under the fan decks, 20.4 mm/min (0.50 gpm/ft²) including the fan opening.

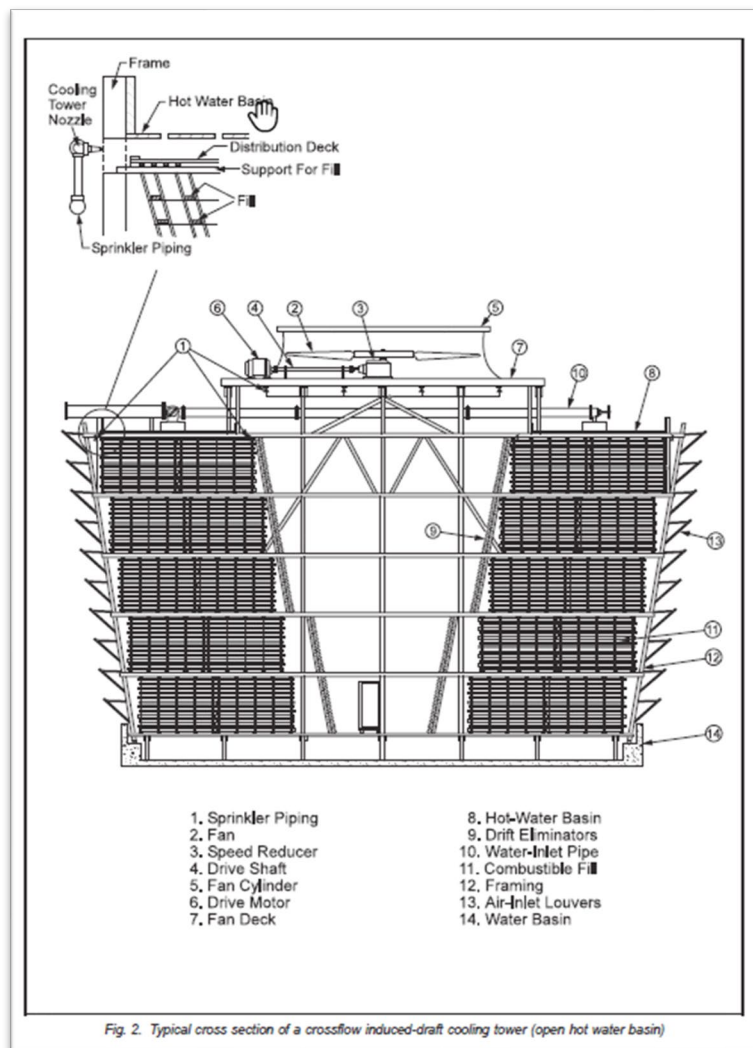

Minimum recommended density as per FM Global Data Sheet 1-6:

- For a combustible fan deck and fill: deluge, 14 mm/min (0.35 gpm/ft²)
- Without a distribution deck below the hot water basin: deluge, 20 mm/min (0.50 gpm/ft²) at a minimum end-head pressure of 170 kPa (25 psi).

Minimum rate of application as per NFPA214:

- Deluge, under the fan decks, 13.45 mm/min (0.33 gpm/ft²) including the fan opening
- Deluge, over the fill area, 20.40 mm/min (0.50 gpm/ft²) including the fan opening

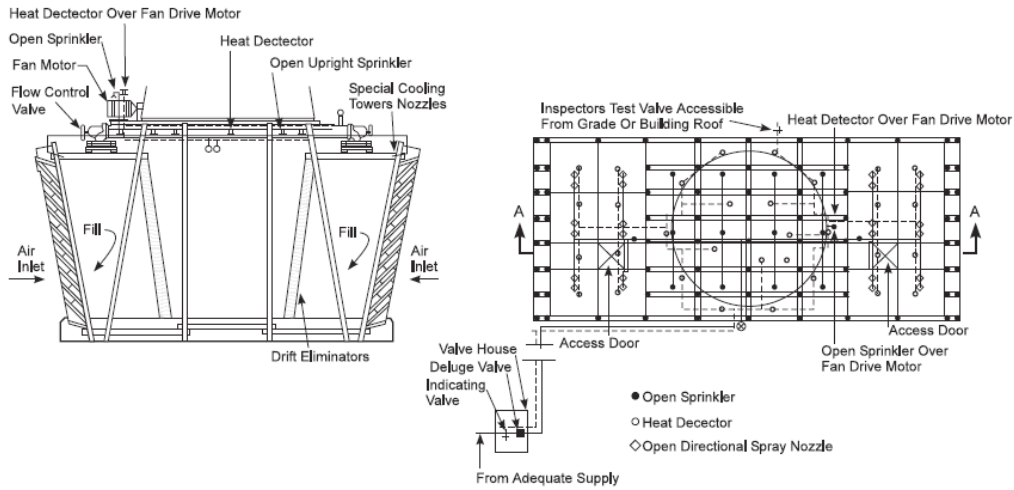

Fig. 3. Typical deluge fire protection arrangement for crossflow cooling towers

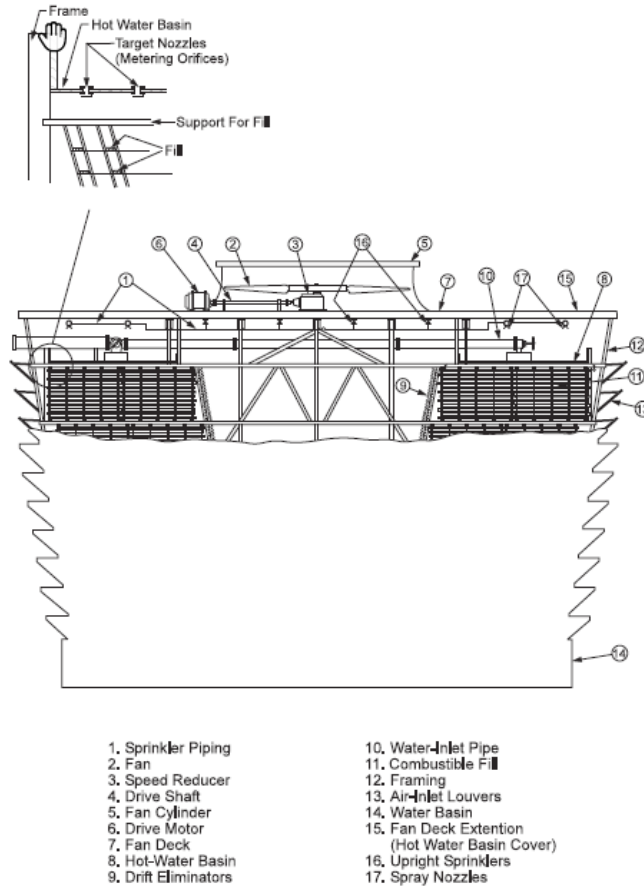

Fig. 4. Typical cross section of a crossflow induced-draft cooling tower (covered hot water basin)

Minimum recommended density as per FM Global Data Sheet 1-6:

- For combustible fill: deluge, 20 mm/min (0.50 gpm/ft²) at a minimum end-head pressure of 170 kPa (25 psi)
- For a non-combustible fan deck extension: deluge, wide angle nozzles -180° water spray- 20 mm/min (0.50 gpm/ft²)
- For a combustible fan deck extension: deluge, wide-angle nozzles 16 mm/min (0.40 gpm/ft²) and additional nozzles on the underside of the fan deck extension - 4 mm/min (0.1gpm/ft²)
- For non-combustible fill: wet / dry pipe, 8 mm/min (0.20 gpm/ft²) at a minimum end-head pressure of 170 kPa (25 psi)

6. HEAT TRANSFER FLUID (HTF)

Heat Transfer systems using organic and synthetic fluid are responsible for numerous losses in the industry. As a result, adequate safeguards and fire protection should be provided in accordance with FM Global Data Sheet 7-99 “Heat Transfer Fluid (HTF) by Organic & Synthetic Fluid” as follows:

The following points should be considered in detail:

- Provide automatic sprinkler protection (EH2) throughout all building areas subject to a heat transfer fluid spill fire. This includes the vaporizer or heater room, user room, and areas containing heat transfer fluid piping. An automatically actuated deluge sprinkler system is an acceptable alternative to an automatic sprinkler system.
- Provide an emergency drain line at the system’s low point(s), piped to one or more vented storage tanks, or to a safe area capable of accommodating the total fluid contents of the system or the part which can be isolated. Drainage may be by gravity flow or by pumps as long as power to the pumps is ensured in the event of an emergency. The same drain lines may be used for both routine and emergency drainage.
- Provide pressure relief devices on the heat transfer system
- System Interlocks: provide measuring instrumentation and interlocks to sound an alarm and automatically shut down the fuel source to the HTF heater or vaporizer when any of the following conditions are detected:
 - Low HTF flow through the heat exchange tubes of the heater, measured at the discharge (i.e. when flow velocity is below that required for turbulent flow).
 - High HTF temperature or pressure at the heater or vaporizer outlet. (Note: Ensure the high temperature interlock is set at, or below, the HTF manufacturer’s maximum recommended bulk fluid temperature).
 - Low pressure at the heater or vaporizer outlet or elsewhere in the system. (Note: This interlock may require a by-pass to allow for conditions at startup).
 - High heat exchanger tube temperature or high film temperature, as measured by thermocouples at the surface of the tubes (optional). (Note: Ensure the set point is at, or below, the HTF manufacturer’s maximum recommended film temperature).
 - Low fluid level in expansion tank
 - Low vaporizer liquid level
 - High temperature of liquid entering the heater or vaporizer (optional if 2. is provided)
 - Sprinkler system flow in any area containing HTF equipment or piping
 - High temperature at bridge wall (optional)
- Interlock the heat transfer system to stop the circulation of fluid throughout the system and to isolate major piping segments in the event of a fire. To accomplish this, provide the following, arranged to actuate either in the event of sprinkler system operations or abnormally low pressure in the heat transfer system, or upon the operation of a heat detection system using FM-Approved and or UL-listed detectors.

The project should be reviewed by a qualified Fire Protection Engineer familiar with NFPA / FM standards.

XII - REFERENCES

SCOR MPL Handbook Property Risks

The following documents were consulted:

1. NATIONAL FIRE PROTECTION ASSOCIATION (NFPA) STANDARDS

- NFPA 13 Standard for the Installation of Sprinkler Systems
- NFPA 15 Standard for Water Spray Fixed Systems for Fire Protection
- NFPA 70, Articles 500 and 505, National Electrical Code
- NFPA 214 Water Cooling Tower
- NFPA 850 Recommended Practice for Fire Protection for Electric Generating Plants and High Voltage Direct Current Converter Stations
- NFPA 2001 Standards on Clean Agent Fire Protection Systems

2. FACTORY MUTUAL GLOBAL DATA SHEETS (FM GLOBAL DATA SHEET)

- 1-6 Cooling Towers
- 1-15 Roof-Mounted Solar Photovoltaic Panels
- 1-20 Protection Against Exterior Fire Exposure.
- 1-40 Flood
- 2-8N, Installation of Sprinkler Systems (NFPA).
- 3-0 Hydraulics of Fire Protection Systems
- 3-26 Fire Protection for Non-storage Occupancies
- 5-4 Transformers
- 5-12 Electric AC Generator
- 5-15 13-14 Electric Generating Stations
- 5-33 Electrical Energy Storage Systems
- 7-101 Fire Protection for Steam Turbines and Electric Generators
- 5-18 Protection of Electrical Equipment Single Phasing and Related Faults
- 5-19 Switchgear and Circuit Breakers
- 5-20 Electrical Testing
- 5-31 Cables and Bus Bar
- 6-6 Boiler Furnace Implosion
- 6-8 Combustion Air Heater
- 6-12 Low Water Protection for Boilers
- 6-13 Waste Fuel-Fired Boilers
- 7-32 Ignitable Liquid Operations
- 7-54 Natural Gas & Gas Piping
- 7.74 Distilleries
- 7.88 Storage tanks for Flammable Liquids
- 7-91 Hydrogen
- 7-98 Hydraulic Fluids
- 7-99 Heat Transfer Fluid (HTF) by Organic & Synthetic Fluid
- 7-106 Ground-Mounted Solar Photovoltaic Power

- 9-19 Wildfire/Bushfire
- 10-03 Hot Work Management
- 10-04 Contractor Management
- 13-3 Utility Steam Turbine-Generators
- 13-10 Wind Turbines
- 13-26 Internal combustion Engine

3. KEMPER TECHNICAL PROCEDURES MANUAL (TPM)

- E-21 Lighting and surge protection
- F-5 Grouped electrical cables
- F-10 Hydraulic fluids
- N-8 Turbine generator fire protection overview

4. OTHER

- CFPA EUROPE (Confederacion Europea de Asoociaciones de Protection Contra Incendio) - E Guidelines: Wind Turbines – Fire Protection Guideline
- GDV (Gesamtverbandes der Deutschen Versicherungswirtschaft): Positionspapier ID- Nummer 6437280268-55 Risikobeurteilung der deutschen Versicherer zum Ausbau der Windenergieerzeugung auf See (WT offshore construction)
- GDV-Broschuere_Erneuerbare_Energien_2013
- Référentiel APSAD D20 Procédés photovoltaïques - Document technique pour la sécurité des bâtiments
- Engineering Insurance of Offshore Wind Turbines, IMIA WGP 45 (06) paper presented at 39th IMIA Annual Conference on 12 September 2006 in Boston
- IMIA WGP 62 (09) "New Challenges for Wind Energy": International Association of Engineering Insurers. Paper presented at IMIA Conference 2009, Istanbul
- IMIA-News-Sheet-27th- OFF Shore code of practice
- IRENA (International Renewable Energy Agency) Smart Grids & Renewables
- Geothermal Energy Association: The Manageable Risks of Conventional Hydrothermal Geothermal Power Systems (factbook on Geothermal Power's Risks and Methods to Mitigate Them)
- National Renewable Energy Laboratory: Application of Geothermal Technology in the Caribbean.

Other publications in this series:

- **RISK CONTROL PRACTICE: CONSTRUCTION MATERIAL**
Wall Assembly Classification Handbook
- **RISK CONTROL PRACTICE: EXPOSURE**
Falling Aircraft Handbook
- **RISK CONTROL PRACTICE: SPECIAL HAZARDS**
 - Embankment Dams Handbook
 - Tailings & Tailings Management Facilities Handbook
 - Stationary Battery Energy Storage Systems Handbook
- **RISK CONTROL PRACTICE: OCCUPANCY**
 - Aluminium Handbook
 - Steel Handbook
 - Wood Processing, Pulp & Paper Industry Handbook
- **RISK CONTROL PRACTICE: LOST ESTIMATE**
 - Maximum Possible Loss (MPL) Handbook

To learn more about SCOR's strategy, goals, commitments and markets, visit our website.

www.scor.com

Follow us on social media



SCOR
The Art & Science of Risk

